

BRExhaust™

A **MAGNAFLOW** GROUP COMPANY

INSTALLATION INSTRUCTIONS | PART NO. 106-0004

BILL OF MATERIALS:

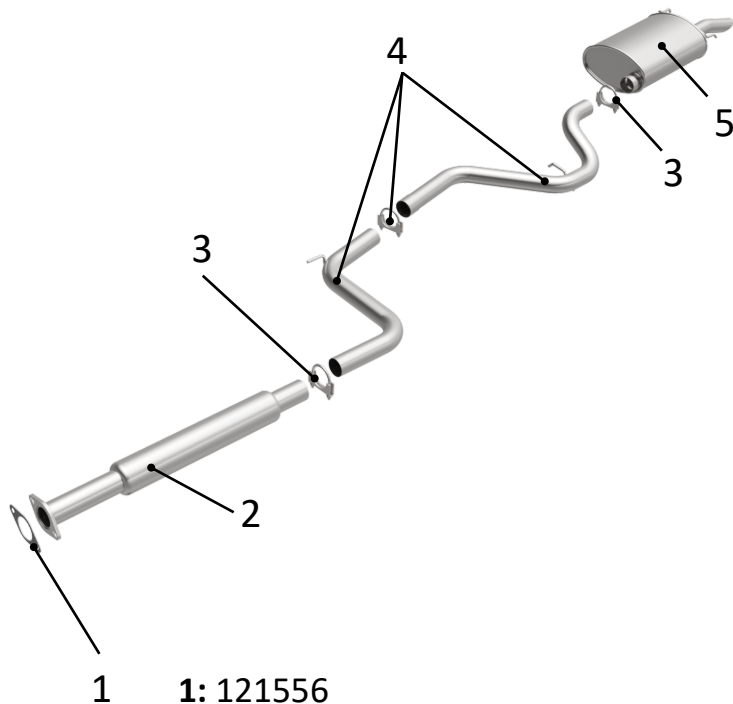

- 1: 121556
- 2: 167513
- 3: 167505
- 4: 167514
- 5: 167512

WARNING:

When working on, under, or around any vehicle exercise caution. Please allow the vehicle's exhaust system to cool before removal, as exhaust temperatures may cause severe burns. If working without a lift, always consult vehicle manual for correct lifting specifications. Always wear safety glasses and ensure a safe work area. Serious injury or death could occur if safety measures are not followed.

STEP 1:

(Carefully read all instructions before installation) Disconnect the vehicle's battery before removal of the OEM exhaust system. This will prevent electrical accidents and will reset the computer if it applies to the vehicle. Remove existing exhaust system from the vehicle. Only remove parts that will be replaced. Clean existing flange with a wire brush to ensure proper sealing.

STEP 2:

Begin installation by installing item 5 to existing isolators.

STEP 3:

Attach outlet of item 4 to item 5 and existing isolator.

STEP 4:

Attach item 1 & 2 to existing exhaust and tighten. (nuts and bolts not included)

STEP 5:

Place inlet of item 4 between item 2 and outlet of item 4.

STEP 6:

Place clamp provided with item 4 between inlet and outlet of item 4.

STEP 7:

Place item 3 on slip fit for item 2 and 4 but do not tighten.

STEP 8:

Place item 3 on slip fit for item 4 and 5 but do not tighten.

STEP 9:

Ensure new exhaust is not contacting any portion of the underbody of the vehicle or drivetrain.

STEP 10:

Tighten all clamps starting from rear of the vehicle. **(DO NOT EXCEED 30FT-LB WHEN TIGHTENING CLAMP AND CHECK ALL CLAMPS AFTER 50 MILES. RETIGHTEN IF NECESSARY)**



BRExhaust recommends professional installation for all products

Technical Support: 1-800-631-7271

BRExhaust — 1901 Corporate Ctr, Oceanside, CA 92056

www.brexhaust.com