



## CARBURETOR 0-80555C MODEL 4175 Installation and Adjustment Instructions

**WARNING!** These instructions must be read and fully understood before beginning installation. Failure to follow these instructions may result in poor performance, vehicle damage, personal injury, or death. If these instructions are not fully understood, installation should not be attempted.

### APPLICATIONS:

P/N	USE	IDLE SYSTEM	SECONDARIES	CFM	SAFETIES
0-80555C	All make, Universal spread-bore replacement carburetor	Forward Idle	Vacuum	650	Power Valve Blow Out Protection

**NOTE:** The 0-80555C is designed to fit GM spread bore passenger car and light truck applications. It is not compatible with Ford or Chrysler Spread bore applications. The 0-80555C is not recommended for any RV applications. The 0-80555C is not designed to pass any emission laws. The 0-80555C is to be used only for competition/off road vehicles or vehicles not required to comply with any exhaust emissions standards.

### INTRODUCTION:

Holley Performance Products has written this instruction sheet for the installation of the **0-80555C Model 4175** universal spread-bore replacement carburetor. This instruction sheet contains all the information needed to install these carburetors. Please read all the **WARNINGS** and **NOTES**. They contain valuable information that can save you time and money. Holley Performance Products cannot and will not be responsible for any alleged or actual engine or other damage, or other conditions resulting from misapplication of the adapter described herein. However, it is our intent to provide the best possible products for our customers; products that perform properly and satisfy your expectations. Should you need information or parts assistance, please contact our Technical Service Department at 1-270-781-9741, Monday through Friday, 8 a.m. to 5 p.m. Central Time. Please have the part number of the product you purchased when you call.

### REMOVAL OF OLD CARBURETOR:

**WARNING!** Prior to and after installing your new carburetor, manually operate the throttle lever and choke mechanism, checking for any sticking or binding. Failure to do so may result in a runaway engine or a wide-open throttle condition, which could result in engine damage, personal injury, or death.

**WARNING!** Due to emission requirements, vacuum lines and hose are becoming more numerous. It is advisable when disconnecting any lines or hoses from your original carburetor to identify and label them in some manner to avoid confusion during the installation of your Holley replacement carburetor. Trace each line back from the carburetor to its individual component, such as the distributor, and then label that line.

**NOTE:** Make a visual inspection of the carburetor, looking for any missing parts, bent levers, or any possible shipping damage.

1. Remove the air cleaner.
2. Label all connections to the carburetor such as: fuel line, PCV vacuum, EGR vacuum, spark-distributor vacuum, air cleaner vacuum, electric choke, and bowl vent.
3. After labeling all connections to the carburetor, carefully disconnect all hoses and lines. When removing the fuel line, remove the steel fuel line carefully, since it will be reused during reinstallation. Slide a rubber cap plug over the end to prevent fuel from running out, which may create a fire hazard.

**DANGER!** DO NOT SMOKE WHEN WORKING AROUND GASOLINE OR GASOLINE VAPORS. EXTINGUISH ALL OPEN FLAMES. AN OPEN FLAME, SPARK, AND/OR EXTREME HEAT COULD RESULT IN A FIRE AND/OR EXPLOSION CAUSING SERIOUS INJURY, DEATH, AND/OR PROPERTY DAMAGE.

4. Remove the throttle linkage and automatic transmission controls from the throttle lever. Disassemble and save the throttle return spring.

5. Disconnect the power brake line from the lower rear of the carburetor, if so equipped.
6. Detach the choke hot air tube and choke air supply tube from the carburetor.
7. Remove the two front and two rear attaching manifold flange bolts. Remove the throttle cable bracket, if so equipped, (located at the right rear attaching bolt). Remove the carburetor by lifting it straight up. Sometimes the carburetor can stick to the manifold gasket, requiring it to be pried loose. Before prying, double check to make sure all the carburetor attaching bolts and connections have been removed.
8. Place clean shop towels or rags into the manifold opening to prevent dirt or debris from entering the engine. Keep exposed ends of the vacuum and fuel lines free from dirt.

**WARNING! Failure to cover the intake opening with a clean towel could result in dirt or debris entering the engine. Dirt or debris in the induction system can cause engine damage, which may necessitate a complete engine overhaul.**

9. Remove the gasket from the intake. Remove any gasket material that may have adhered to the manifold. **DO NOT** gouge the intake manifold sealing surface during the removal of old gasket material.
10. Remove the shop towels from the intake and vacuum out the intake channel to ensure no dirt or debris is left in the intake system. Place a clean shop towel over the entire intake opening until you are ready to install the new carburetor.
11. Remove the solenoid, if any, from the existing carburetor. To retain the use of the solenoid, it will be required to purchase Holley's throttle solenoid bracket, P/N 20-47. Install the original solenoid and retaining nut in the Holley bracket. Applications on which the solenoid is welded to the bracket and is not removable will require a new Holley throttle solenoid bracket P/N 20-47 and solenoid P/N 46-74.

#### **FLUSHING THE FUEL LINES:**

During fuel line installation, be careful to avoid introducing any dirt particles which could enter the fuel inlet and jam open the needle and seat resulting in the carburetor flooding, malfunctioning, and/or possible engine fire. In all cases where the fuel line has been cut, it is essential that it be cleaned to prevent contamination from entering your new carburetor, the fuel line must be flushed of rust, dirt, or other debris.

**WARNING! Holley DOES NOT recommend the procedure where the coil wire is disconnected, the engine cranked for a few revolutions, and the fuel is collected in a container. This procedure is unsafe because sparking can occur either at the coil, or at the distributor end of the coil wire, which may ignite any fuel spilled in the engine compartment.**

1. Disconnect the fuel line at the fuel pump.
2. Using a compressed air source, blow the fuel line clean.

**DANGER! FLUSH FUEL LINES ONLY IN A WELL-VENTILATED AREA AND AWAY FROM ALL SOURCES OF HEAT OR FLAME. FAILURE TO FOLLOW THESE INSTRUCTIONS MAY CAUSE GASOLINE VAPORS TO IGNITE RESULTING IN A FIRE OR EXPLOSION WHICH MAY RESULT IN SERIOUS INJURY AND/OR DEATH.**

**WARNING! Wear eye protection when performing this step. Failure to wear eye protection can result in gasoline or other contaminants entering the eye that could result in permanent eye damage and/or blindness.**

#### **INSTALLATION OF NEW CARBURETOR:**

**WARNING! All fuel system components, including the carburetor and fuel and vacuum lines, should be inspected periodically for fuel and vacuum leaks. Any hoses, which exhibit surface cracks when bent to a 180° position, should be replaced. The fuel bowl screws should be torqued to 25-30 in./lbs. Recheck fuel bowl screw torque during the vehicle's regular maintenance schedule.**

**WARNING! Holley Performance Products highly recommends that a quality fuel filter be installed with any replacement carburetor to catch any dirt that may still remain in the system. Any dirt that may enter the carburetor can cause the carburetor to flood or malfunction. A carburetor that has a malfunction caused by dirt in the system on part of the owner will void the warranty.**

1. Install the four (4) manifold flange studs (provided) from the package.
2. Install the new flange gasket (provided), over the manifold flange studs.
3. Place the carburetor in position over the four flange studs and secure in place with the four nuts provided. Tighten the nuts in a criss-cross pattern to 60 in./lbs. **DO NOT** overtighten the nuts.

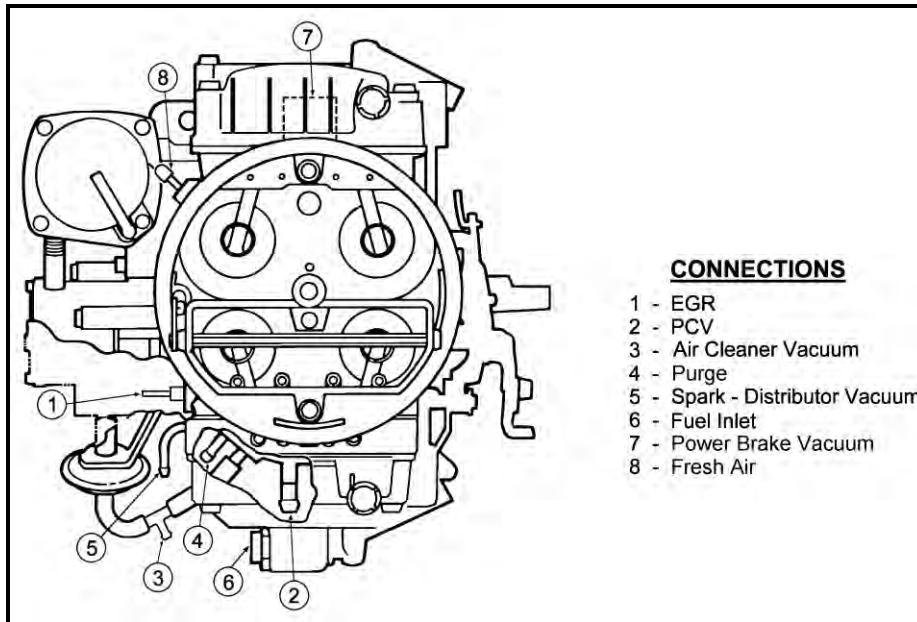

Figure 1

**WARNING!** Overtightening the carburetor manifold flange hold-down nuts may result in a warped or cracked carburetor throttle body. The carburetor hold-down nuts should be tightened down progressively in a criss-cross pattern to 60 in./lbs., so that vacuum leaks are prevented and to avoid causing damage to the throttle body. A carburetor that has been damaged due on part of the owner will void the warranty.

4. Attach the fuel line. It is highly recommended that a quality inline fuel filter, such as a Holley P/N 162-505, be installed between the fuel pump and the carburetor.
5. Connect the throttle linkage, transmission kickdown linkage, and return springs. Operate the linkage to assure correct travel by fully opening and closing the throttle by hand.
6. Adjust the transmission kickdown linkage, if used. Refer to your vehicle's service manual for information on the proper installation and adjustment procedures.

**WARNING!** Failure to follow the vehicle's service manual for proper installation and adjustment of the transmission kickdown linkage may result in transmission damage.

7. Reconnect all vacuum lines that were labeled in the removal of the old carburetor. Use Figure 1 as a guide to locate the connections. The full manifold vacuum source in the front of the throttle body provides vacuum for proper operation of the air cleaner, the air pump diverter valve (if vehicle is so equipped) and/or the temperature sensing valve. The timed spark fitting in the choke side of the primary metering block provides vacuum for operation of the distributor vacuum advance. Connect the hose to the distributor, spark delay valve, and/or temperature-sensing valve. If vacuum for more than one component is needed, plastic "Ts" (available at most automotive parts stores) may be used to complete this installation. Plug any vacuum connections that are not used.
8. Connect the PCV hose to the PCV fitting in the carburetor. See Figure 1. Connect the solenoid wire to the original source wire.
9. This carburetor is equipped with an electric choke. The wire in the small parts bag should be secured to the terminal on the choke cap, with the other end connected to an ignition activated 12V source.

**WARNING!** Connecting the choke cap to the ignition coil will result in unacceptable choke operation, poor fuel economy, and possible engine misfiring since the voltage delivered to the spark plugs will be severely reduced by the drain imposed by the choke. Suitable ignition activated 12V sources are most electrical relays as well as the leads to accessories, such as the windshield wipers. Check the voltage source with a volt-ohm meter to assure proper voltage and choke operation.

**STARTING:**

1. Without operating the throttle, crank the engine. It may take 15 to 30 seconds of cranking to allow the fuel bowls of the carburetor to fill. If the engine does not start, stop cranking, open and close the throttle twice and crank again until the engine starts.

**WARNING!** DO NOT crank the engine for more than 15 seconds at a time. Cranking longer than 15 seconds can overheat the starter, resulting in premature starter failure.

2. After starting the engine, check the fuel lines and inlet fittings for possible fuel leaks.

**WARNING! If any fuel leakage or weeping is detected, shut off the engine immediately, and wipe up any fuel. Locate the source of the leak and correct it before proceeding any further.**

#### TUNING AND ADJUSTMENT:

Before you begin to tune your carburetor for your particular vehicle, you must get a "FEEL" for your vehicle's performance so that any changes you make (good or bad) will be readily apparent. Be patient and **make only one change at a time**, so that only that change can be fully analyzed. This cannot be overemphasized, as there are no "short-cuts" to peak performance. Recording each change and the resulting performance increase or decrease will provide you with a "Handbook" of how the vehicle performance is affected by individual carburetor adjustments. This may be helpful in the future or on other applications.

#### FUEL LEVEL (Float Level):

The float(s) controls the fuel delivery, however if the float(s) are not properly adjusted, a fuel starvation or a flooding affect could result. This operation is difficult to do accurately on a rough-idling vehicle. Most non-adjustable fuel bowls do not require adjustment, hence, no adjustment on the fuel bowl. However, in the rare case that fuel level adjustment is required here are the steps for adjustment.

1. Place shop rags under the fuel bowl to catch any spilled fuel.

**WARNING! Wipe up any spilled fuel. Spilled fuel may ignite on a hot engine resulting in a fire or explosion causing serious injury, property damage, and/or death.**

**DANGER! DO NOT SMOKE WHEN WORKING AROUND GASOLINE OR GASOLINE VAPORS. EXTINGUISH ALL OPEN FLAMES. AN OPEN FLAME, SPARK, AND/OR EXTREME HEAT COULD RESULT IN A FIRE AND/OR EXPLOSION CAUSING SERIOUS INJURY, DEATH, AND/OR PROPERTY DAMAGE.**

2. Remove the fuel bowl and hold it inverted at eye level. See Figure 2.

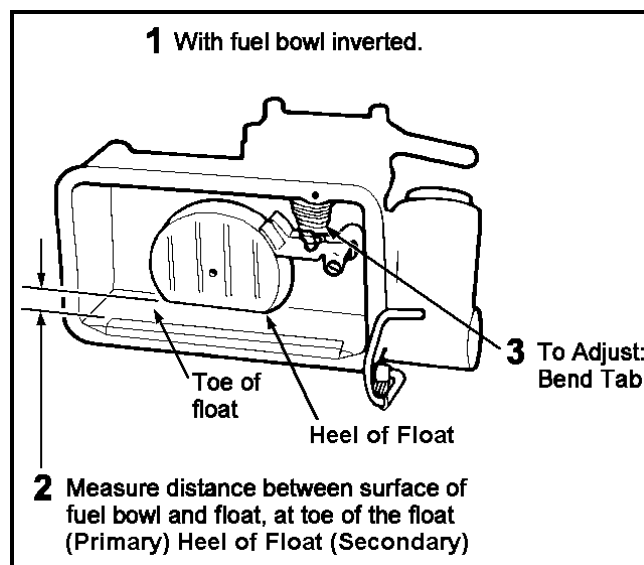

Figure 2

3. Measure the distance between the surface of the fuel bowl and the toe of the float for the primary side of the carburetor. Measure the distance between the surface of the fuel bowl and the heel of the float on the secondary side of the carburetor. The float should almost be parallel to the surface of the fuel bowl. If a higher fuel level is needed to bend the tap downward towards the top of the fuel bowl as it would be installed on the main body. Lower the fuel level by bending the tab towards the bottom of the fuel bowl, as it would be installed on the main body.
4. Install the fuel bowls, after adjustment, using a new fuel bowl gasket. A new fuel bowl gasket must be used to prevent any future fuel leaks.
5. For a mechanical fuel pump, remove the coil wire and crank the engine over for 10 seconds to allow the fuel bowls to fill. This procedure can prevent a power valve blow out. Reconnect the coil wire when finished. For electric fuel pumps, let the fuel bowls fill in stages by turning the ignition on and then off, letting the fuel pump run for a few seconds at a time. This procedure can prevent the needle from being forced up at an angle not allowing the needle to seat properly.

**WARNING! If any fuel leakage or weeping is detected, shut off the engine immediately and wipe up any fuel. Locate the source of the leak and correct before proceeding any further.**

### **IDLE SPEED SCREW:**

The idle speed screw in most cases is the only screw you should adjust. The idle screw controls the throttle plate position at idle, which in turn raises or lowers the engine rpm by allowing more or less air/fuel mixture into the engine. It does not control the air/fuel mixture. Here are the proper steps for setting the engine's idle speed.

1. Find the proper idle rpm on the underhood decal of your vehicle. If this decal is not available, find a service manual that references your vehicle and engine. Find the recommended idle rpm.
2. Start the engine and allow it to warm up.
3. Connect a tachometer, if your vehicle is not so equipped.
4. Make sure the parking brake is on and the wheels are blocked. Place the automatic transmission in drive, the manual transmission in neutral or as stated on the underhood decal.
5. If the idle speed is slower than recommended, turn the screw clockwise to speed up the rpm. If the idle speed is too fast, turn the idle screw clockwise to slow down. This adjustment should be made to both the primary and secondary screws in equal amounts, so that the throttle plates are opened the same amount.

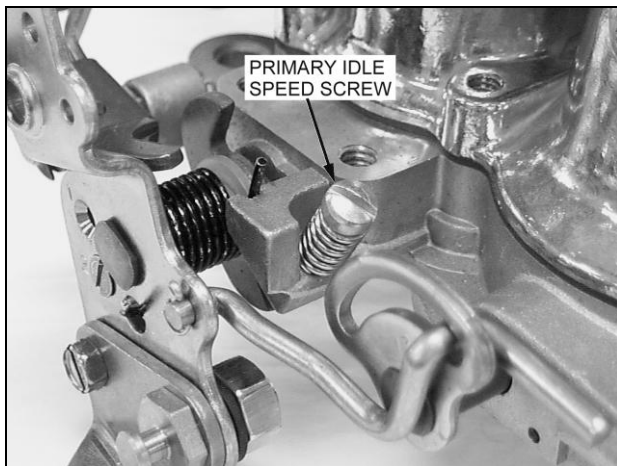

**Figure 3**



**Figure 4**

### **IDLE MIXTURE NEEDLES:**

Idle mixture needles control the air/fuel mixture at idle. The amount of air/fuel mixture used at idle is controlled by engine vacuum. When tuning the idle mixture, you are actually tuning the best manifold vacuum. Idle mixture needles are found on the metering blocks. Your carburetor will have two idle mixture needles on one metering block. If you change one idle mixture needle, you are required to change the other idle mixture needle the same amount. Here are the proper steps for setting the idle mixture needles.

1. Attach the vacuum gauge to the manifold vacuum port usually at the rear of the carburetor and on the throttle body.
2. Adjust each idle mixture screw the same amount to achieve the highest possible vacuum reading without increasing the idle speed screw.
3. Now that the idle mixture is set, it may be necessary to go back and reset the idle speed using the idle speed screw. Continue back and forth between the tuning of the idle mixture needles and the idle speed screws until little change is noticed in the manifold vacuum and the idle speed is correct.

### **FAST IDLE SCREW:**

The fast idle screw works in conjunction with the choke by setting the idle speed while warming up. If your engine idles fine when it's warm, but too fast or too slow when cold, then this screw will need adjustment. Use the engine service manual for your vehicle to set the rpm. Here are the proper steps for setting the fast idle.

1. Check the choke tension. The choke must not stick and should work smoothly. If it doesn't, it will cause high idle speeds.
2. With the engine warmed up and the air cleaner off, turn off the engine.
3. Holding the choke butterfly closed with one hand, partially open the throttle and let it close.
4. Release the choke butterfly. This will position the choke fast idle cam in the cold start position.

5. Start the engine without moving the accelerator pedal or throttle.
6. The engine should start and idle at approximately 2000 rpm. If not, the fast idle screw should be adjusted until it does.
7. Move the throttle. The choke should open and the engine should return to normal idle.

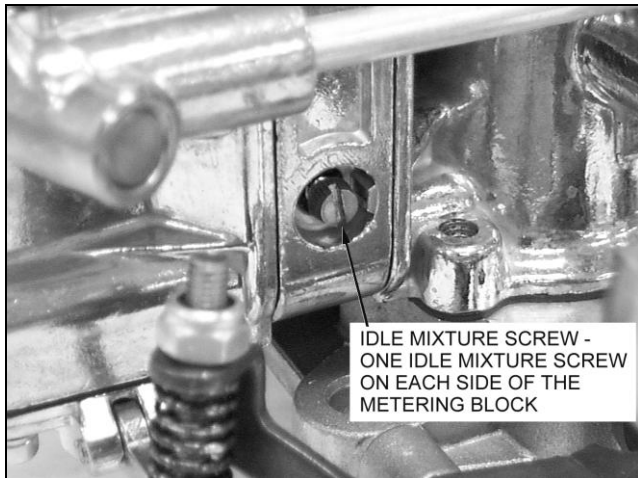

Figure 5

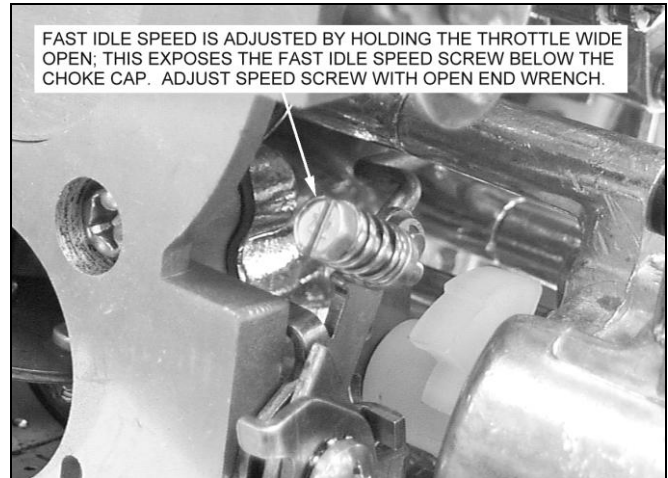

Figure 6

### ACCELERATOR PUMP:

The accelerator pump's purpose is to make up for the lag in fuel delivery to enable the engine speed to increase in response to throttle opening. Differences in vehicle weight, transmissions, and rear axle ratios affect the amount of fuel and the delivery rate that should be provided by the accelerator pump. This may necessitate the customizing of your accelerator pump to your vehicle and its use.

**NOTE:** The old saying, "if a little is good, a lot is better", does not apply to the proper tuning of the accelerator pump. Your car's performance can be just as bad if it receives "too much fuel, too soon" as if it receives "too little fuel, too late."

Two factors that affect the accelerator pump's delivery are the **pump cam** and the **pump shooter** (discharge nozzle). The pump cam determines the total volume of fuel and affects delivery rate. The pump shooter affects delivery rate and helps determine the duration of the shot.

The pump cams (purchased separately) have two operating locations each. This provides for several distinct delivery rates. In general, the #1 locations on the pump cams provide moderate initial delivery with greater final delivered volume. The #2 locations on the pump cams provide greater initial delivery with a lesser total delivered volume. The pump shooters have a number stamped on their casting that designates the shooter size in thousandths of an inch, i.e., a #25 shooter has a .025" discharge orifice. The smaller diameter nozzles lengthen the pump shot duration and are used with heavier vehicles or with vehicles equipped with lower numerical rear axle ratios. Larger diameter nozzles (.035-.037) shorten the pump shot duration, but deliver a greater initial volume of fuel. These sizes should be used on applications where engine speed will increase rapidly (vehicles with good power-to-weight ratios). Best acceleration is achieved when the accelerator pump delivers the lean, best power, air/fuel ratio to the engine, not when the maximum volume of fuel is supplied.

Best starts or racing starts usually result when the rear tires break loose for the first 10 to 25 feet. This allows the engine speed to increase rapidly to get the secondary main nozzles started. If wide tires that provide extremely good traction are used, do not permit the rear tires to break loose. Bogging could result. Best times may be recorded with narrower tires. This attention to tire size is not so important on vacuum-operated secondary carburetors, since the secondary throttles will not open until the secondary nozzles are exposed to enough vacuum to get them started.

1. Change pump shooters until the smallest diameter nozzle that provides the crispest response is found.
2. Then change the pump cams and locations until the right cam is found that provides even more response.
3. Finally, change the pump shooter once again until the crisp response is maximized.

**NOTE:** If a nozzle size is desired that seems "in between" the nozzle sizes provided, then the nozzle can be drilled to the desired size by using a wire drill held in a pin vise.

4. At this point, there should be no bogs, flat spots, or black smoke (indicating excessive richness) when accelerating at wide-open throttle from a standing start.

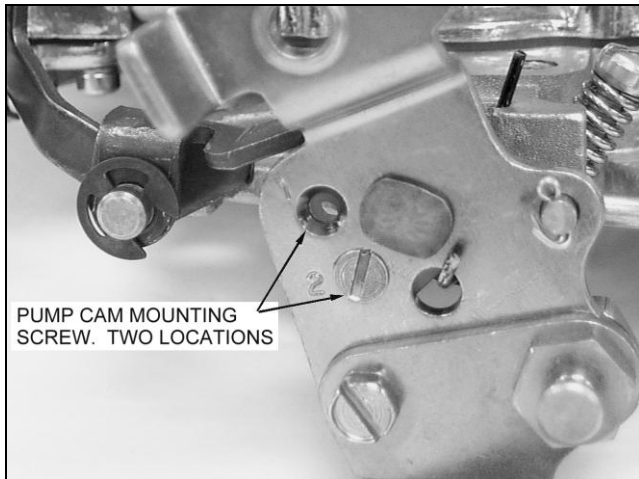

Figure 7

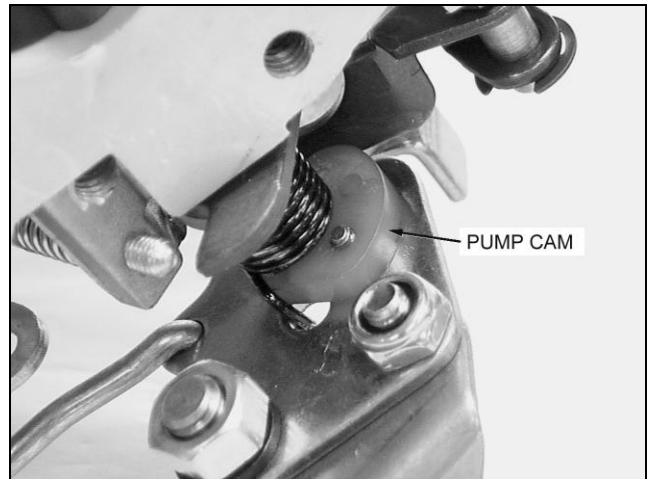

Figure 8

### VACUUM OPERATED SECONDARY THROTTLES:

Many people have the misconception that opening the secondary throttle plates sooner will provide increased performance and quicker drag strip times. Others think they must “feel” a kick when the secondaries engage. Still others believe that they should disconnect the vacuum diaphragm and make the secondaries open mechanically.

Before going any further, let’s discuss these points in a reverse order. First, if we could make our vacuum operated secondary carburetors perform better by opening the secondaries mechanically, it would be to our advantage to do so since all that vacuum actuating hardware is expensive and requires much time and money to calibrate. Mechanical secondary carburetors all utilize a pump shot to prevent bogging when the secondaries are opened. Secondly, those who “feel” a kick when the secondaries engage are actually feeling a flat spot during initial acceleration because the secondaries have already begun to open and have weakened the fuel delivery signal to the primary boosters. The engine is struggling to increase speed and what they actually feel are the secondary nozzles “crashing in” as the engine finally reaches the speed where it provides the proper fuel delivery signal to primary and secondary venturi. Third, opening the secondaries early causes the situation described above. The secondaries must not open until the engine requires the additional air, allowing torque to increase along the peak torque curve. Performance is compromised less by holding the secondaries closed a little longer than by opening them a little too soon. If the opening rate of the vacuum operated secondaries is properly calibrated there should not be a “kick”, only a smooth increase in power should be felt.

In general, heavier cars require stiffer secondary diaphragm springs than light cars. Air cleaner configuration and restriction plays an important part in spring selection also, so be sure to use your air cleaner when evaluating your vehicle’s performance after each change. **DO NOT** expect to “wing” the throttle and see the secondaries begin to open. If they do, they will probably open too soon. Secondaries should open only when the engine is under a load. **DO NOT** clip a spring in an effort to make a spring lighter so that the secondaries will open sooner. Strange as it may seem, clipping springs actually increases spring rate and will delay opening. So in order to tune the secondaries, follow the steps below. The secondary springs are available from your local Holley retailer.

1. Remove the four screws securing the diaphragm cover.
2. Gently remove the cover and change the spring. The stiffer the spring, the later the secondaries will open. The lighter the spring, the earlier the secondaries will open.
3. Remove and change the spring.
4. Reassemble in the reverse order. **DO NOT** pinch or tear the rubber diaphragm.

### JETTING (MAIN JETS):

Due to varied applications that a universal performance carburetor will work with, no additional tuning jets have been included. However, a few tips on jetting are provided to help you understand their purpose.

1. Out of the box jetting is extremely close for most applications.
2. In most cases, it will be unnecessary to increase jet size more than four numbers greater than out of the box jetting. However, exceptions could arise when the carburetor is mounted on a very large volume, plenum-ram manifold.
3. Carburetors are calibrated at 70° at sea level. Decrease the jet size one number (approx. .002) for approximately every 2000 ft. increase in altitude. Increase jet size one number for every 35° drop in temperature.

4. Holley jets are broached, flowed, and stamped according to flow rate. **Never drill jets**. This seriously alters flow characteristics. Stamped numbers are reference flow numbers and **DO NOT** indicate drill size.
5. Spark plugs provide the best indication of proper jetting. Allow plugs to cool before jumping to conclusions.
6. When used with high velocity emission manifolds, some older calibrations actually show power increases when jet size is lowered a couple of number sizes below stock jetting.

#### **AIR BLEEDS:**

Experimenting with air bleeds is not recommended. Countless hours of testing have been performed on expensive flow stands to obtain the proper bleed size for a given calibration. It is unlikely that a better air bleed calibration can be obtained without extensive experience and facilities. It is most likely that a useless piece of junk can result from what was previously a high performance carburetor.

#### **POWER VALVES:**

The number stamped on a power valve, such as a 65, indicates the manifold vacuum below which the power valve is operational. In this case, all manifold vacuums below 6.5" Hg, the power valve is operating. Generally a 65 power valve is sufficient for most high performance applications that have a manifold vacuum of 12" Hg or higher. However, some problems can result with radically cammed, full-race machines equipped with automatic transmissions. These vehicles often "idle" at 2000 rpm, approx. 6.0" Hg. At this point, the main nozzles are starting to feed and richen the mixture (supplied by the power valve) and the engine will probably "load up". To correct this problem, install a 45 or 35 power valve. If the engine has a manifold vacuum of 12" Hg or less, a good way to determine power valve size is to take the manifold vacuum at idle and divide that number by two. The answer is the power valve size. This will provide idling and proper fuel flow under wide-open throttle conditions when the manifold vacuums seldom rise above 1" Hg.

#### **GENERAL INFORMATION:**

This instruction sheet cannot contain all of the information that may be desired by some individuals. Further clarification is available in **HOLLEY CARBURETORS**, published by H.P. Books and available at your Holley distributor, P/N 36-73.

1. An in-line filter should be installed between the fuel pump and the carburetor.
2. Recommended fuel pressure should be set at 7-1/2 psi maximum, 5 psi minimum. Fuel pressure above 7-1/2 psi can create severe fuel control problems and are not recommended.
3. Fuel lines should be a minimum of 3/8".
4. A non-restrictive open-element air cleaner kit is recommended under Holley P/N 120-102.
5. The pump cam adjustment kit is available under Holley P/N 20-12.
6. Vacuum secondary diaphragm springs that vary secondary opening are available under Holley P/N 20-13. For additional parts and accessories, see the Holley Performance Parts Catalog.

**Holley Technical Support**  
**1801 Russellville Road**  
**Bowling Green, KY 42101**  
**270-781-9741**  
**www.holley.com**

**199R-10012-1**  
Date: 1-31-11