

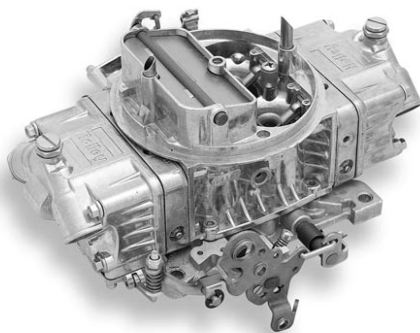

# HIGH PERFORMANCE TUNING INSTRUCTIONS

FOR HOLLEY PERFORMANCE CARBURETORS



**199R-7849-2**

**NOTE:** These instructions must be read and fully understood before beginning installation. If this manual is not fully understood, tuning should not be attempted. Failure to follow these instructions, including the pictures may result in subsequent system failure.

# TABLE OF CONTENTS:

INTRODUCTION: .....	2
CARBURETOR REMOVAL: .....	3
DISASSEMBLY:.....	3
CLEANING:.....	3
REASSEMBLY:.....	3
INSTALLATION: .....	3
TUNING:.....	5
IDLE MIXTURE NEEDLES.....	5
ACCELERATOR PUMP .....	6
VACUUM OPERATED SECONDARY THROTTLES: .....	7
JETTING (MAIN JETS): .....	9
POWER VALVES: .....	9
AIR BLEEDS: .....	9
JET EXTENSIONS: .....	9
GENERAL:.....	9

## INTRODUCTION:

**CONGRATULATIONS** on your purchase of Holley Trick Kit! We feel that you have purchased the finest performance parts manufactured today. Should you need information or parts assistance, please contact our Technical Service Department at 1-270-781-9741 or 1-866-GOHOLLEY, Monday through Friday, 7 a.m. to 5 p.m. CST. Please have the part number of the product you purchased on hand when you call.

**To preserve warranty, these instructions must be read and followed thoroughly before and during installation.**

**NOTE:** The tuning instructions are intended to supplement the rebuilding instructions provided with this kit. It is important that the carburetor be rebuilt and adjusted to the proper specifications before any performance tuning is attempted on the carburetor.

**NOTE:** Some performance modifications (particularly those which affect primary throttle calibration) may alter the exhaust emissions performance of the vehicle and should be considered for off-road use only.

**NOTE:** Two barrel carburetors should be “tuned” in the same manner as the primary side of a four barrel carburetor.

# CARBURETOR REMOVAL:

1. Remove the air cleaner, exercising care to carefully detach any vacuum lines from the air cleaner and marking them so they can be reattached to the air cleaner in the same manner.
2. Remove the existing carburetor by the following procedure:
  - A. Carefully disconnect the fuel line(s).

**WARNING: Carefully protect the open end of the fuel lines, so that no foreign particles can enter. Wrap the end of the fuel line with a clean lint-free cloth.**

- B. Disconnect and mark all vacuum lines and wiring (if any) to the carburetor.
  - C. Disconnect the PCV hose.
  - D. Disconnect the choke rod or heat tubes (if equipped).
  - E. Disconnect and remove the throttle linkage and automatic kickdown linkage. **Save all retaining clips.**
  - F. Unbolt and remove the carburetor from the manifold.
3. Remove original carburetor flange gasket and scrape the carburetor flange of the intake manifold clean exercising care not to drop pieces of gasket material into the intake manifold. It is recommended to cover the manifold bores when the carburetor is removed to prevent unwanted debris from entering the engine.

# DISASSEMBLY:

1. Disassemble carburetor according to the steps provided in the accompanying rebuild sheet.

**CAUTION:** In some cases, small steel balls or steel needle weights are used as check valve devices in carburetor sub-assemblies. Care should be exercised so that these pieces are not accidentally lost.

2. If possible, disassemble the carburetor on a large, clean, flat surface so that any parts that are dropped may be found easily.
3. Organize disassembled parts in order of disassembly.

# CLEANING:

1. Use a reputable carburetor cleaner. Soak the main body, throttle body, and metering blocks long enough to remove all gum and varnish deposits. A parts brush or tooth brush can be used to help remove heavy accumulations. Fuel bowls, which do not have intricate passages, should only be exposed to carburetor cleaner long enough to permit removal of gum and varnish deposits with a brush.

**WARNING: Some fuel bowls have internal o-ring seals which are not removable, but can be damaged by prolonged exposure to some carburetor cleaning solvents.**

2. If recommended by the carburetor cleaner manufacturer, rinse parts in a suitable solvent (or hot water).
3. If possible, blow parts dry with compressed air; wipe dry with a clean lint-free cloth, and allow to dry thoroughly.

# REASSEMBLY:

1. Reassemble carburetor in reverse order of disassembly, using new gaskets, power valves, inlet needle and seats, and diaphragms; but retain the original pump discharge nozzle(s), accelerator pump cam(s), and secondary throttle diaphragm spring.

**NOTE:** Reassemble carburetor to stock form, so fine tuning efforts can be analyzed with respect to the original calibration.

# INSTALLATION:

1. Install the flange gasket making sure it is oriented properly on the intake manifold.

- Place the carburetor on top of the flange gasket on the manifold. Install the hold down nuts and snug down progressively in a “crisscross” pattern (60-80 in./lbs.), as shown in Figure 1.

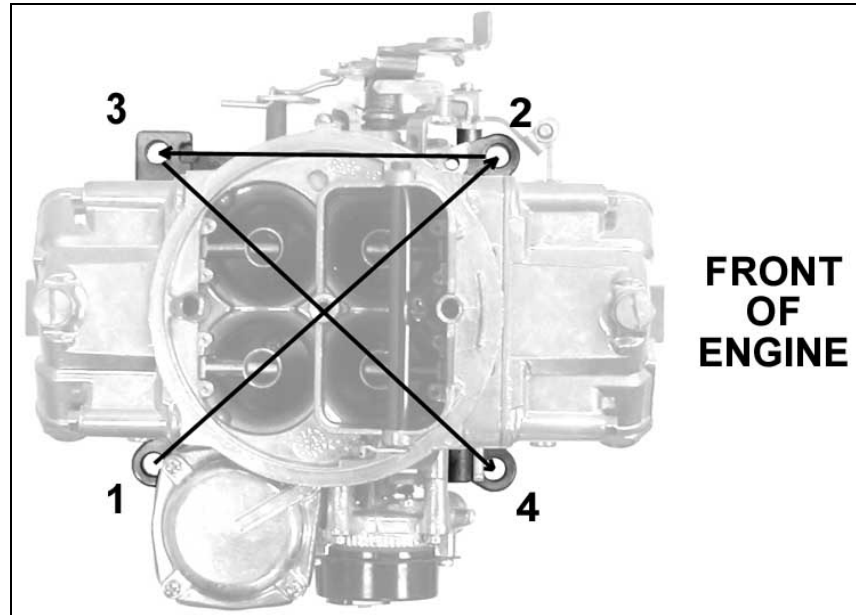

Figure 1—Carburetor hold-down nut torque sequence

**WARNING:** Overtightening may result in a warped or cracked carburetor throttle body.

- Before connecting the linkage, operate the throttle lever to assure the correct travel (no sticking or binding), by opening to wide-open throttle and back to closed throttle several times. Correct any sticking or binding conditions before proceeding.

**WARNING:** Any sticking, binding, or other interference in the throttle linkage could result in uncontrolled engine speed. This could result in engine damage or personal injury.

- Reconnect the throttle and transmission kickdown linkage and throttle return spring (Holley P/N 20-89). Operate the carburetor throttle lever by hand to assure the correct travel (no sticking or binding) by opening to wide open throttle and back to closed throttle several times. Correct any sticking or binding conditions before proceeding.

**NOTE:** With the engine turned off, have an assistant slowly press the accelerator pedal to the floor, while you watch the throttle for any sticking or binding. Correct any sticking or binding conditions before proceeding. Also ensure that you are reaching full throttle. Many performance problems are traced to partial throttle openings from improperly adjusted linkage. Secondaries will not open mechanically during this procedure.

- Reconnect the appropriate vacuum and PCV hoses to the carburetor. Replace any cracked or dry rotted hoses at this time to prevent any vacuum leaks.
- Reconnect the fuel line(s).

**WARNING:** During the fuel line installation, DO NOT allow any foreign particles to enter the fuel lines, which could then cause flooding and may result in a fire.

**WARNING:** Keep the fuel line away from the EGR valve (if equipped) on the intake manifold.

**CAUTION:** The use of a quality in line fuel filter, such as Holley P/N 162-523 is mandatory as a safeguard against possible flooding, which could result from unfiltered particles becoming lodged between the fuel inlet needle and its seat. This can result in fire if a spark is present or backfire occurs in the engine compartment. Air cleaner filter elements should be blown clean with compressed air at 6,000 miles and replaced at 12,000 miles to assure maximum protection. Now would be the perfect time to upgrade to a Holley Powershot air filter (Holley P/N 120-146).

- Start the engine and check the fuel lines and inlet fitting for possible leaks.

**NOTE:** The recommended fuel pressure is 5-7 psi.

- Recheck to assure all existing vacuum hoses are attached properly. Plug any fittings not used.

9. With the engine at operating temperature, set the idle speed to the manufacturer's specifications
10. If the carburetor is equipped with sight plugs, recheck fuel level with engine idling.
11. The accelerator pump should be adjusted so that the slightest movement of the throttle lever results in actuation of the accelerator pump. The pump override spring adjustment is checked while holding the throttle in the open position and the pump operating lever held in a fully compressed position. The clearance between the adjusting nut and the arm of the pump lever should be .015". See figure 2

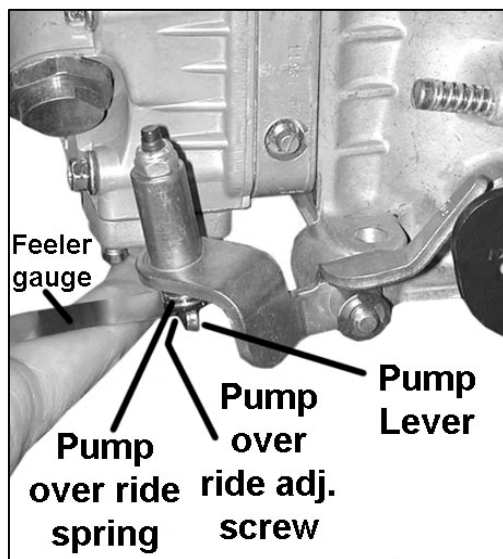

**Figure 2—Accelerator Pump Adjustment Procedure**

12. After making this adjustment, move the throttle lever from a closed position toward open. Any movement at the throttle lever should be noticed at the pump operating lever. This indicates correct tip-in.

**NOTE:** Under no circumstances should the pump override spring be adjusted to permit coil bind (or bottoming). This is sometimes recommended by some "experts" as a means to a quicker delivery rate and increased flow. All that such "adjustments" accomplish is to provide bent accelerator pump actuating levers and ruptured pump diaphragms. Override springs are carefully sized to provide proper delivery pressure without damaging vital carburetor parts by momentarily absorbing pump force and regulating the pressure peaks within the system.

## TUNING:

Before you begin to tune your carburetor for your particular vehicle, you must get a "feel" for your vehicles performance so that any changes you make (good or bad) will be readily apparent. Be patient and make only one change at a time so only that change can be fully analyzed. This cannot be over emphasized as there are no "short-cuts" to peak performance. Recording each change and the resulting performance increase or decrease will provide you with a handbook of how vehicle performance is affected by individual carburetor adjustments. This may be helpful in the future or on other applications.

### IDLE MIXTURE NEEDLES

Idle mixture needles control the air/fuel mixture at idle. When tuning the idle mixture, you're actually tuning for the best manifold vacuum. Idle mixture needles are found on the primary metering blocks. If you change one idle mixture needle, you must change the other idle mixture needle by the same amount. Here are the proper steps for setting the idle mixture needles.

1. Attach a vacuum gauge to a manifold vacuum port on the throttle body.
2. Lightly seat the mixture screws by turning clockwise. Now turn them out 1.5 to 2 turns. This will give you a good starting point.
3. Adjust each idle mixture screw (Figures 3 & 4) 1/8 turn at a time, alternating between each screw. Turn them equally, until you achieve the highest possible vacuum reading without adjusting the curb idle speed screw. Turn screws in to lean the mixture. Turn them out to richen the mixture.
4. Now that the idle mixture is set, it may be necessary to go back and reset the idle speed using the curb idle speed screw.

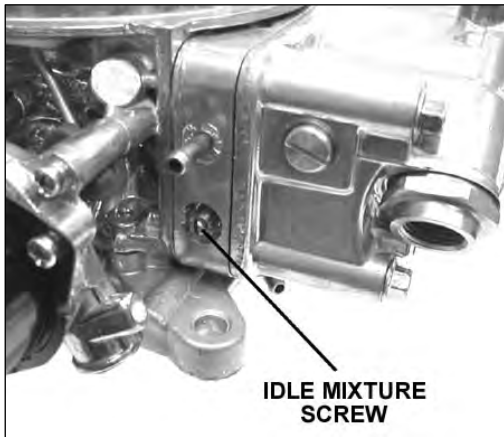

Figure 3



Figure 4

5. If a vacuum gauge is not available, use a tachometer to obtain the highest RPM.

## ACCELERATOR PUMP

The accelerator pump system consists of three main components: the pump diaphragm, the pump cam and the pump nozzle. This is the carburetor system that is most responsible for having good, crisp, off-idle throttle response. Its purpose is to inject a certain amount of fuel down the throttle bores when the throttle is opened. By accomplishing this purpose it acts to smooth the transition between the idle and main circuits so that no stumble, hesitation or sluggishness will be evident during this transition phase.

**NOTE:** The old saying “if a little is good, a lot is better” does not apply to the proper tuning of the accelerator pump. Your car’s performance can be just as bad if it receives too much fuel as if it receives too little fuel.

Two factors affect the accelerator pump’s delivery: First, The amount of fuel that can be delivered by one accelerator pump stroke. This is determined by the pump’s capacity and the profile of the pump cam. Secondly, the period of time that it will take for this pre-determined amount of fuel to be delivered. This is affected by the pump nozzle size.

### Pump Nozzle or “Shooter”

A larger pump nozzle will allow this fuel to be delivered much sooner than a smaller pump nozzle. If you need more pump shot sooner, then a larger pump nozzle size is required. During acceleration tests, if you notice that the car first hesitates and then picks up, it’s a sure bet that the pump nozzle size should be increased. A backfire (lean condition) on acceleration also calls for a step up in pump nozzle size. Conversely, if off-idle acceleration does not feel crisp or clean, then the pump nozzle size may already be too large. In this case a smaller size is required.

Holley accelerator pump nozzles are stamped with a number (Figure 5) which indicates the drilled pump hole size. For example, a pump nozzle stamped “35” is drilled .035”. Pump nozzle sizes are available from .025” to .052”. Please note that whenever a .040” or larger accelerator pump nozzle is installed the “hollow” pump nozzle screw should also be used. This screw will allow more fuel to flow to the pump nozzle, assuring that the pump nozzle itself will be the limiting restriction in the accelerator pump fuel supply system.

**NOTE:** When changing the pump nozzle it’s best to jump three sizes. For example, if there is currently an off-line hesitation with #28 (.028”) pump nozzle, try a #31 (.031”) pump nozzle.

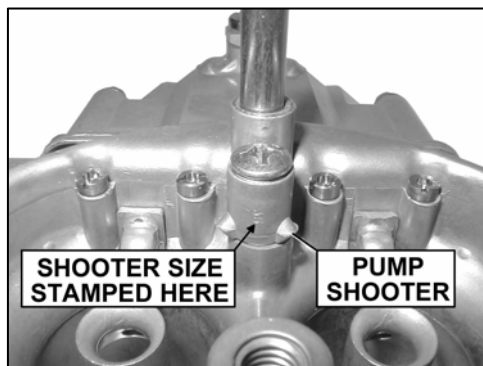

Figure 5: Accelerator pump discharge nozzles are changed by removing a large Phillips hold down screw. **NOTE:** There is a small gasket under the head of the screw and one between the nozzle casting and the main body.

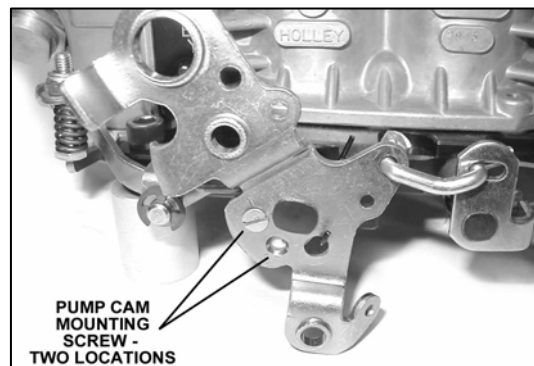

Figure 6: Accelerator pump cams are held in place with this small slotted screw. The pump lever should operate instantly with the slightest throttle rotation when cam is properly installed.

## Pump Cams

Once a pump nozzle size selection has been made the accelerator pump system can be further tailored with the pump cam. Holley offers an assortment of different pump cams, each with uniquely different lift and duration profiles that are available under Holley P/N 20-12. Switching cams will directly affect the movement of the accelerator pump lever and, subsequently, the amount of fuel available at the pump nozzle. Lay out the pump cams side by side and note the profile differences. This little exercise may help to better explain the differences between the cams and their effect on pump action.

Installing a pump cam is straightforward (Figure 6). It's a simple matter of loosening one screw, placing the new pump cam next to the throttle lever and tightening it up. There are two and sometimes three holes in each pump cam, numbered 1, 2 and 3. Placing the screw in position #1 activates the accelerator pump a little early, allowing full use of the pump's capacity. Generally, vehicles which normally run at lower idle speeds (600 or 700 RPM) find this position more useful because they can have a good pump shot available coming right off this relatively low idle. Positions #2 and #3 delay the pump action, relatively speaking. These two cam positions are good for engines that idle around 1000 RPM and above. Repositioning the cam in this way makes allowance for the extra throttle rotation required to maintain the relatively higher idle setting. Pump arm adjustment and clearance should be checked and verified each and every time the pump cam and/or pump cam position is changed.

## VACUUM OPERATED SECONDARY THROTTLES:

Many people have the misconception that opening the secondary throttles sooner will provide increased performance and quicker drag strip times. Others think they must "feel" a kick when the secondaries engage. Still others believe that they should disconnect the vacuum diaphragm and make the secondaries open mechanically.

Before going any further, let's discuss these points in a reverse order. First, if we could make our vacuum operated secondary carburetors perform better by opening the secondaries mechanically, it would be to our advantage to do so since all that vacuum actuating hardware is expensive and requires much time and money to calibrate. Mechanical secondary carburetors all utilize a secondary pump shot to prevent bogging when the secondaries are opened. Secondly, those who "feel" a kick when the secondaries engage are actually feeling a flat spot during initial acceleration, because the secondaries have already begun to open and have weakened the fuel delivery signal to the primary boosters. The engine is struggling to increase speed and what they actually feel are the secondary nozzles "crashing in" as the engine finally reaches the speed where it provides the proper fuel delivery signal to primary and secondary venturi. Third, opening the secondaries early causes the situation described above. The secondaries must not open until the engine requires the additional air. This allows torque to increase along the peak torque curve. Performance is compromised less by holding the secondaries closed a little longer than by opening them a little too soon. If the opening rate of the vacuum operated secondaries is properly calibrated there should not be a "kick", only a smooth increase in power should be felt.

This kit contains three secondary diaphragm springs. The larger diameter of the wire the stiffer the spring and the later the secondaries will open.

Secondary diaphragm springs are replaced as follows:

1. Remove the choke cap and choke housing to gain access to the third screw retaining the vacuum diaphragm to the main body (Figure 7).
2. Remove three screws attaching secondary vacuum diaphragm to the main body (Figure 8).

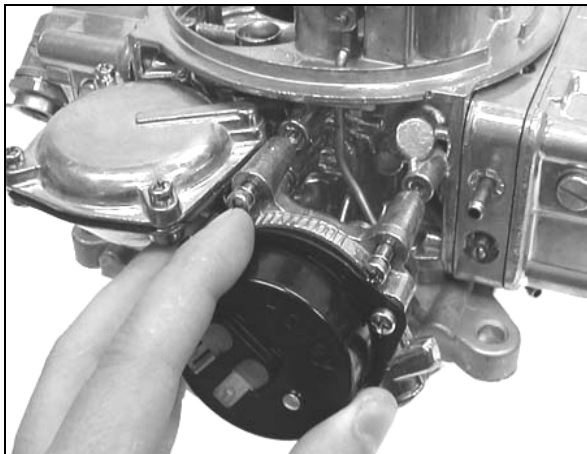

Figure 7

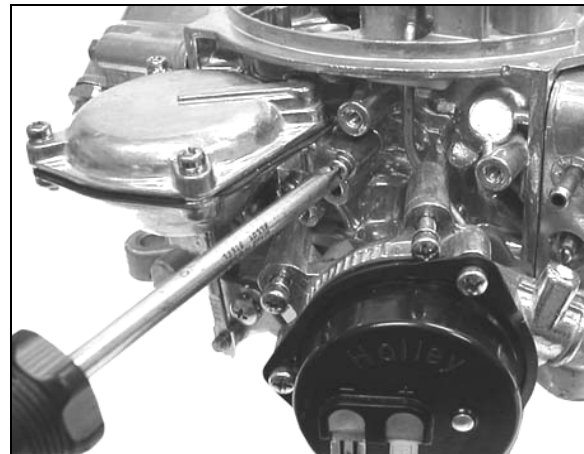

Figure 8

- Remove the clip retaining the diaphragm plunger to the secondary throttle lever using a small flat-blade screwdriver (Figure 9).

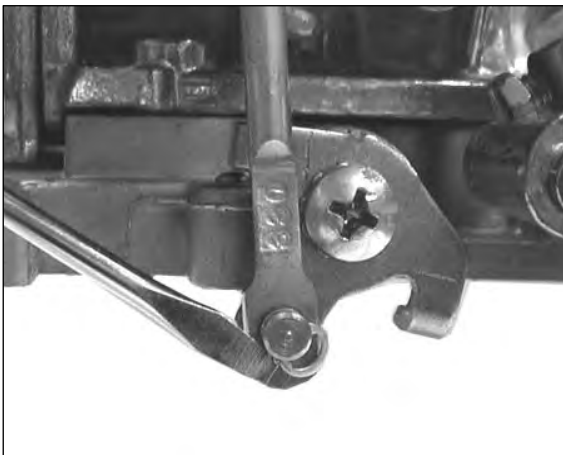

Figure 9

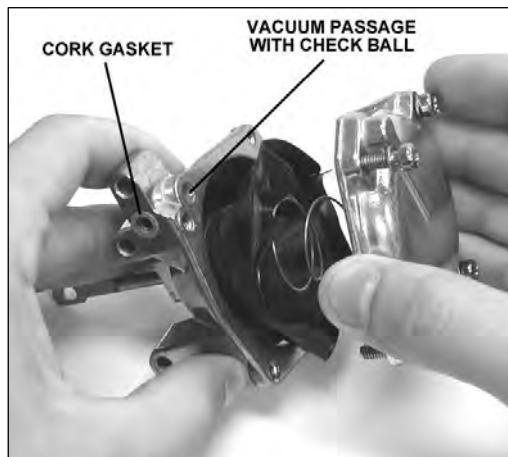

Figure 10

- Remove the four screws securing diaphragm cover.
- Gently remove the cover. Take care as not to tear the diaphragm or lose the check ball (Figure 10).
- Change the spring. Make sure that the new spring seats on the stud cast into the underside of the cover. The stiffer the spring, the later the secondaries will open.
- When reassembling secondary diaphragm parts, exercise care to properly align the vacuum passage in the casting with the "cut out" in the rubber diaphragm, and make sure the check ball is in place. **DO NOT** pinch or tear the rubber diaphragm.

**TIP:** To make reassembling the diaphragm easier, extend the diaphragm into the housing and form the diaphragm into a "mushroom" shape (Figure 11). Then position the diaphragm over the bolt holes and vacuum port. Hold the diaphragm in that position with your fingers while inserting the spring, cover, and bolts to avoid disturbing the position of the diaphragm.



Figure 11

- Make sure the cork gasket in the secondary diaphragm housing mates with the main body casting and reassemble the housing and choke to the main body.
- Reinstall the air cleaner, and test drive the vehicle.

In general, heavier cars require stiffer secondary diaphragm springs than light cars. Air cleaner configuration and restriction plays an important part in spring selection also, so be sure to use your air cleaner when evaluating your vehicles performance after each change. **DO NOT** expect to "wing" the throttle and see the secondaries begin to open. If they do they will probably open too soon. Secondaries should open only when the engine is under a load. **DO NOT** clip or trim a spring in an effort to make a spring lighter so that the secondaries will open sooner. Strange as it may seem, clipping springs actually increases spring rate and will delay opening. If additional springs are required, they may be purchased from your local Holley retailer (Holley P/N 20-13).



## JETTING (MAIN JETS):

Due to varied applications that a universal performance carburetor will work with, no jets have been included in this kit; however a few tips on jetting are provided to help you understand their purpose.

1. Out of the box jetting is extremely close for most applications.
2. Carburetors are calibrated at 70° at sea level. Decrease the jet size primary and secondary, one number for every 2000 ft. increase in altitude.
3. Holley jets are broached, flowed, and stamped according to flow rate. **NEVER** drill jets, as this seriously alters flow characteristics. Stamped numbers are reference numbers and **DO NOT** indicate drill size.
4. In most cases it will be **unnecessary** to increase jet size more than four numbers greater than out of the box jetting. Exceptions could arise when the carburetor is mounted on a very large volume, plenum-ram manifold.
5. Spark plugs provide the best indication of proper jetting. Consult an ignition manual for proper reading of spark plugs.

## POWER VALVES:

The number stamped on a power valve, such as 65, indicates the manifold vacuum below which the power valve is operational. In this case, all manifold vacuums below 6.5" Hg, the power valve is operating. Generally a 65 power valve is sufficient for most high performance applications that have a manifold vacuum of 12" Hg or higher. However, some problems can result with radically cammed engines equipped with automatic transmissions. These vehicles often "idle" at 2000 rpm, approx. 6.0" Hg. At this point the main nozzles are starting to feed and richen the mixture (supplied by the power valve) and the engine will probably "load up". To correct this problem, install a 45 or 35 power valve. If the engine has a manifold vacuum of 12" Hg or less, a good way to determine power valve size is take the manifold vacuum at idle and divide that number by two. The answer is the power valve size. This will provide idling and proper fuel flow under wide open throttle conditions when manifold vacuums seldom rise above 1" Hg.

## AIR BLEEDS:

Experimenting with air bleeds is not recommended. Countless hours of testing on expensive flow stands is required to obtain the proper bleed sizes for a given calibration. It is unlikely that a better bleed combination can be obtained without extensive experience and facilities.

## JET EXTENSIONS:

Jet extension (Holley P/N 122-5000) can be used in conjunction with the secondary main jets to prevent the jets from being uncovered as fuel rushes to the back of the fuel bowl during extreme acceleration. Jet extensions require the use of a notched float. If you do not have a notched float, a notched float with jet extension is available as Holley P/N 116-10

## GENERAL:

For some strip use it is recommended to discard the moraine fuel filters which are sometimes installed behind the fuel inlet. If this is done install an inline Holley fuel filter P/N 162-523, between the fuel pump and the carburetor.

### Recommended fuel pressure:

7-1/2 psi maximum

5 psi minimum

**NOTE:** Fuel pressures above 7-1/2 psi can create severe fuel control problems and are not recommended.

This instruction sheet cannot contain all of the information which may be desired by some individuals. Further clarification is available in *Holley Carburetors*, published by H.P. Books and available at your local Holley distributor (Holley P/N 36-73) or by purchasing the *Holley Installation and Tuning* DVD available at [www.holley.com](http://www.holley.com)

**Holley Performance Products, Inc.  
P.O. Box 10360  
Bowling Green, KY 42102-7360**

**Technical Service: 1-866-GOHOLLEY  
Phone: 1-270-781-9741  
Fax: 1-270-781-9772**

**For online help, please refer to the Tech Service section of our website: [www.holley.com](http://www.holley.com)**

Printed in U.S.A.  
Copyright © 2007

Date: 4-4-07

10

**Holley**  
Performance Products

**199R-7849-2**