



Installation Instructions Quarter Stick® Shifter

Fits: GM Powerglide auto transmissions w/aluminum case and forward or reverse valve body. Also fits GM TH250, 350, 400 and 375 auto transmissions w/reverse valve body.
Catalog# 3162001

WORK SAFELY! For maximum safety, perform this installation on a clean, level surface and with the engine turned off. Place blocks or wedges in front of and behind both rear wheels to prevent movement in either direction.

CAUTION: To avoid any possibility of bodily injury or damage to vehicle, do not attempt installation until you are confident that the vehicle is safely secured and will not move.

Note: All adjustments must be made with shifter and transmission in Neutral (N). All adjustments are critical and **MUST** be precise.

Do not mix components (all parts including cable must be Hurst components provided in kit).

If a shifter is removed and reinstalled, adjustments must be checked and re-adjusted.

Always check cable for freedom of motion before connecting at shifter and transmission arm.

Routing of cable should avoid sharp bends (permanent damage of cable will result.)

IMPORTANT: Ensure that cable has adequate clearance around headers and exhaust system. Excessive heat will melt the cable liner and result in cable breakage.

Failure to comply with any of the above may result in malfunction of shifter operation. Damage to cable due to sharp bending, kinking, or excessive heat is not covered by Warranty.

These instructions detail the installation of the Hurst Quarter Stick® Shifter for GM Powerglide 2 speed transmission with both forward and reverse pattern valve bodies and GM Turbo TH 350/400 3 Speed transmission with a reverse pattern valve body only. Please refer to the specific instructions for your particular application for detailed information. See the illustration on page 4 for changing from 2 speed to 3 speed operation.

The shifter can be mounted directly to the floor with the four sheet metal screws supplied.

3 SPEED APPLICATIONS – TH350/400 TURBO-HYDRAMATIC

All turbo installations use this bracket. Refer to drawings below for method of fastening.

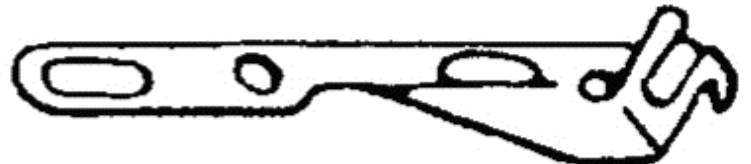

**Transmission Cable Bracket
Part No. 117 4778**

400 TURBO-HYDRAMATIC

Use stock bolts to fasten end holes of bracket to transmission.

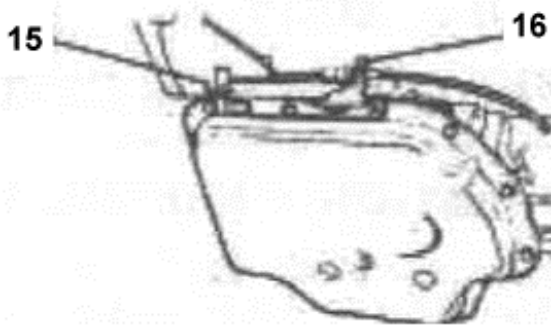

350 TURBO-HYDRAMATIC

Install with 5/16-18x3/4" socket head cap screw located at rear of center slot in bracket (bracket forward as far as possible). Use stock pan bolt in front slotted hole of bracket.

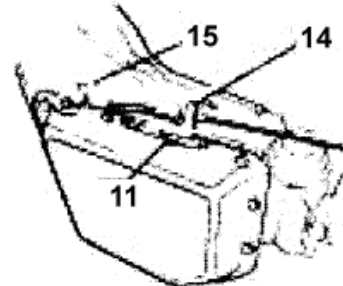

200 TURBO-HYDRAMATIC

Install bracket with 5/16-18x3/4" socket head cap screw located in the middle of the center slot in bracket. Use stock pan bolt in front slotted hole of bracket. Adjust in either direction for proper neutral alignment.

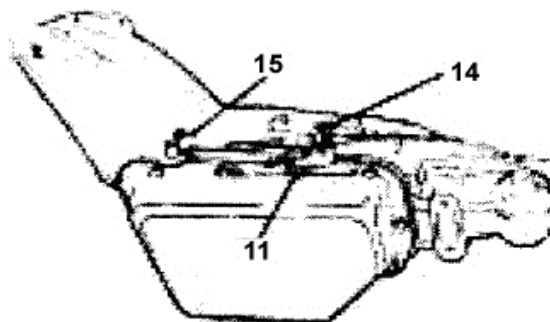

ATTACH CABLE END TO
PIN ON SHIFTER STICK

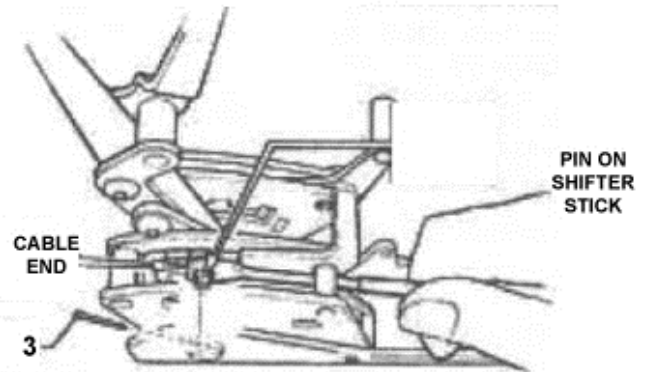

ALIGNMENT PROCEDURE

1. Position shifter stick at "N" (Neutral).
2. Position transmission arm at "N" (Neutral).
3. Adjust cable as directed in instructions.
4. Fasten cable end on pin with cotter pin.

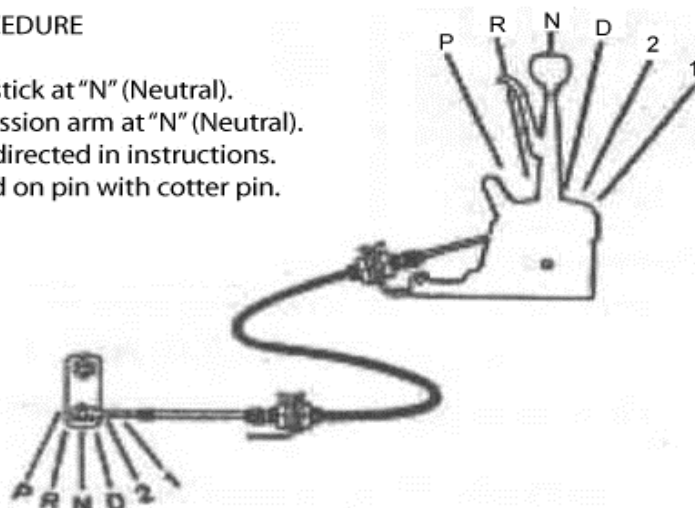

With shifter mounted in the desired location, direct eyelet end of shifter cable through shifter frame. Secure shifter cable to frame using cable clip, push clip down until it is firmly seated. Put shifter in neutral and slide cable eyelet over pin on shifter stick (see exploded view), install cotter pin (p/n 1900001) through hole in shifter pin to hold cable in place.

Remove stock transmission arm. Refer to the illustration for your transmission and install the proper Hurst transmission arm per the directions. Install the corresponding cable bracket per the illustration. Carefully route the shifter cable towards the cable bracket (avoid any sharp bends as cable can become permanently damaged). Insert cable eyelet through slot in mounting bracket and secure using cable clip, push clip down until it is firmly seated.

Thread cable pivot onto threaded end of cable. Make sure that the transmission is in neutral. Thread cable pivot in or out on the cable until it lines up directly with the hole in the transmission arm. Lock cable pivot in this position with the 10/32 nut supplied on the shifter cable. Insert cable pivot into hole in transmission arm. Carefully shift through each gear (up and down) and check for free entry of cable pivot into transmission arm at each gear position. Re-adjust if necessary to insure proper engagement in each gear. When satisfied with adjustment, secure cable pivot to transmission using supplied 1/16"x1" cotter pin.

Route cable in transmission tunnel, avoid binding or kinking of the cable. Make sure that the cable is not too close to or in contact with the exhaust system. When you are satisfied with the routing, secure the cable to the chassis using the supplied cable clamps. Drill a 1/4" hole in the tunnel or frame, fold clamp around cable and push the split end through the 1/4" hole. Push the pointed end into the split end until it snaps tight.

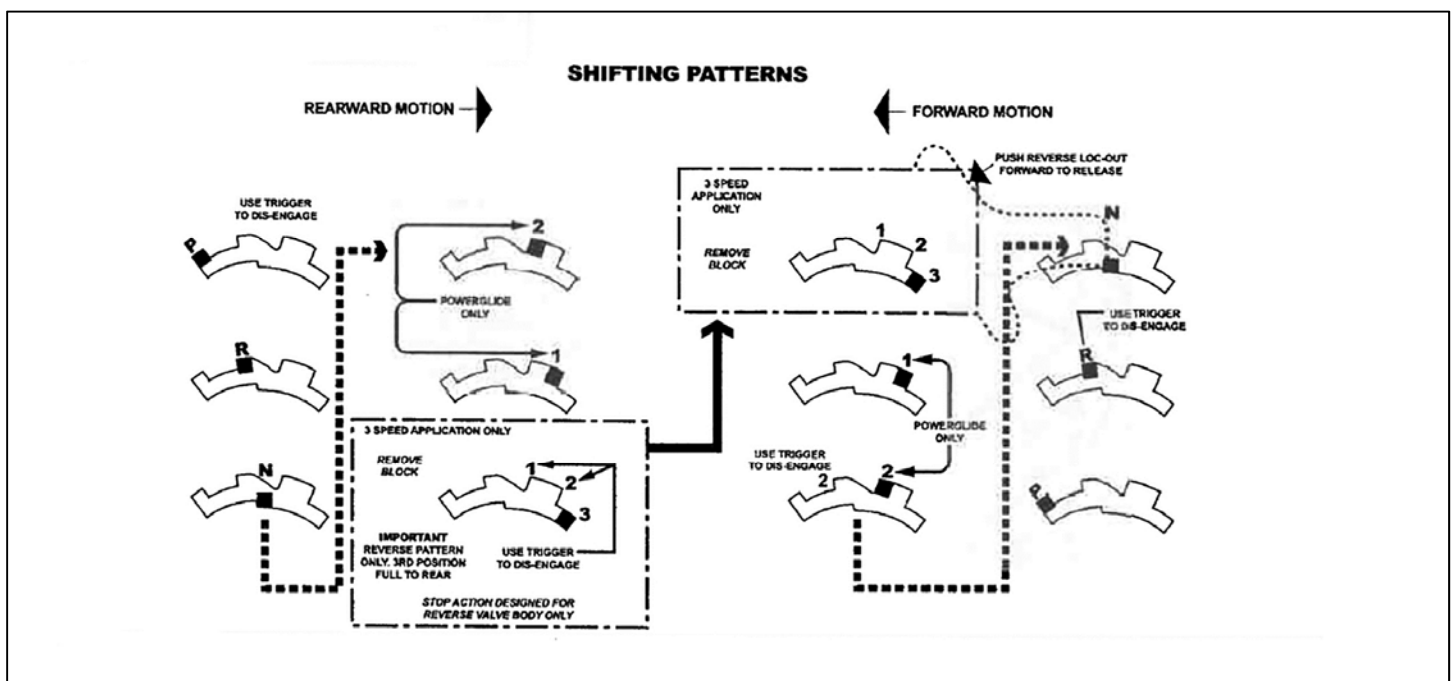

POWERGLIDE APPLICATIONS

WARNING!

IMPORTANT

Installation of Quarter Stick shifter on Powerglide transmission eliminates throttle pressure control linkage (kickdown valve).

Powerglide installation of the Hurst Quarter Sticks is for racetrack use only. Under no circumstances is this shifter to be used in a vehicle that is operated on public highways or streets. In no case shall Hurst Performance, Inc. be liable for any direct or consequential damages resulting from improper use of this unit.

IMPORTANT

Do not allow foreign matter (dirt, metal chips, etc) to enter the transmission or contaminate any internal parts. If necessary, wash parts in solvent and blow them dry with compressed air.

Use a hacksaw to cut the protruding part of the transmission away to allow cable bracket installation. Clean all metal chips away from transmission before removing oil pan. Remove all stock linkage. Drain the transmission fluid. Remove the oil pan.

See Figure 1

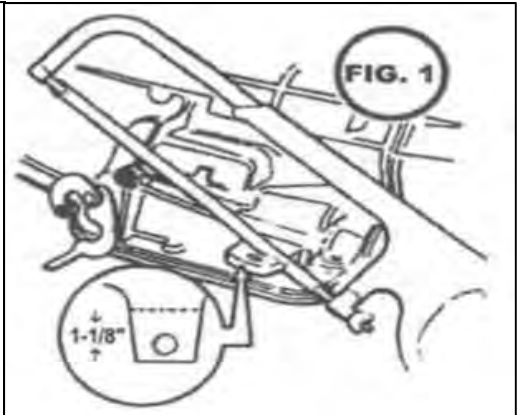

Remove the two screws that fasten detent guide plate over internal end of control linkage. Remove guide plate.

See Figure 2

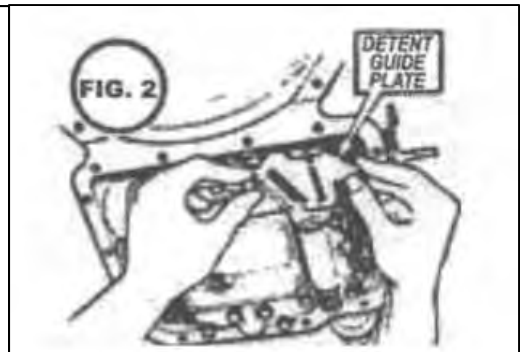

Loosen screw that fastens the extension spring anchor plate to release tension on the detent roller.

See Figure 3

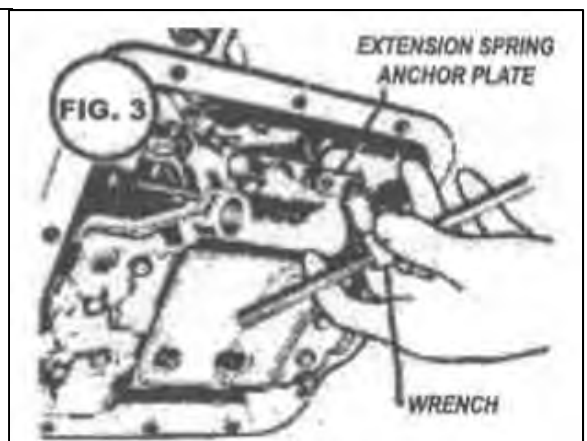

Loosen socket head cap screw that fastens the throttle pressure actuator (transmissions that have throttle pressure control). Grasp the actuator and pull the throttle pressure control shaft out of transmission control shaft. Stock transmission control shaft is now ready for removal.

NOTE: Installation of the solid control shaft supplied with this kit (P/N 105 0084) in Powerglide transmission eliminates throttle pressure control.

See Figure 4

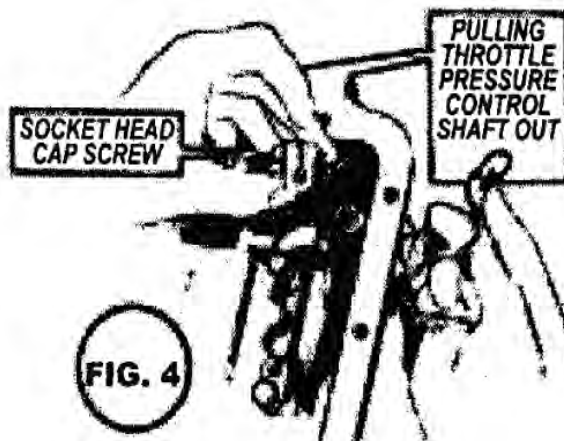

The flat area on the end of the solid control shaft (P/N 105 0084) fits within the span of the serrations in the detent plate. Loosen socket head cap screw that fastens detent plate to control shaft. Grasp detent plate carefully to keep it in position as you withdraw original shaft and replace it with the solid shaft (P/N 105 0084). Detent plate is linked to PARK lock actuator plunger. Take care to keep this assembly in position while exchange of control shafts is accomplished. You must hold detent plate in position with one hand while you remove original shaft and install the solid one. Stud pin in detent plate must engage the groove in the manual valve. Tighten socket head cap screw to fasten detent plate to control shaft. Align detent roller with detent plate, then tighten anchor plate screw to restore tension to extension spring. Replace detent guide plate. Rotate detent plate through full travel to ensure correct assembly. (P-R-N-D-L)

See Figure 5

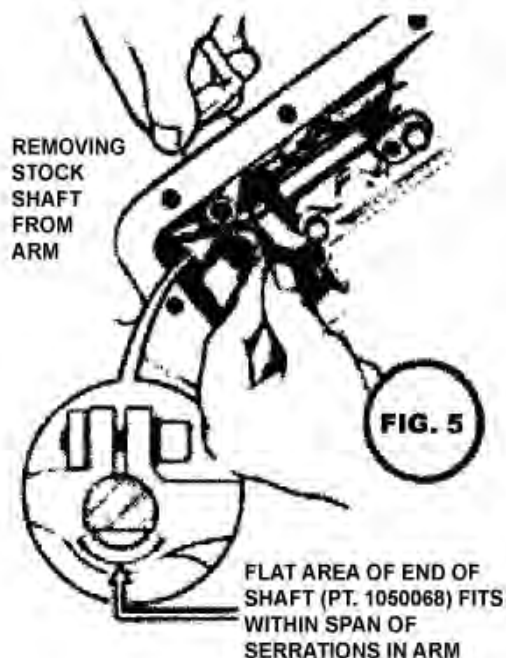

Make cuts with hacksaw. Break away small length between cuts as seen in Figure 6. Flatten lip of flange between the extreme cuts with ball peen hammer as shown in photograph. Inspect reworked area of oil pan flange. Gasket mating surface and areas around bolt holes must be flat. Use ball peen hammer to peen flange flat (with pan properly supported on anvil, etc.). Clean pan thoroughly in solvent. Install oil pan with new gasket. Cable bracket is installed with pan bolts. Tighten all bolts evenly. Install fresh transmission fluid.

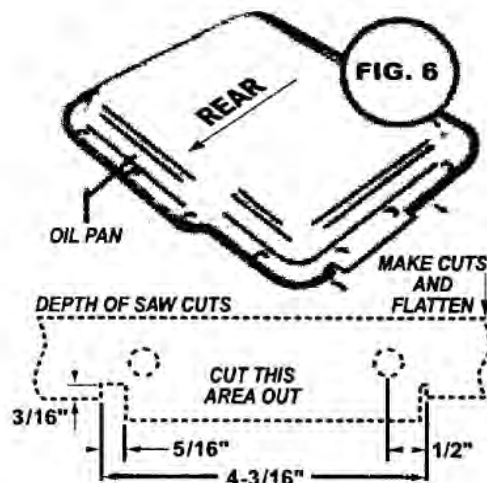

CAUTION
 AVOID SHARP BENDING OF CABLE. CABLE WILL BE PERMANENTLY DAMAGED BY ANY SHARP BENDING.

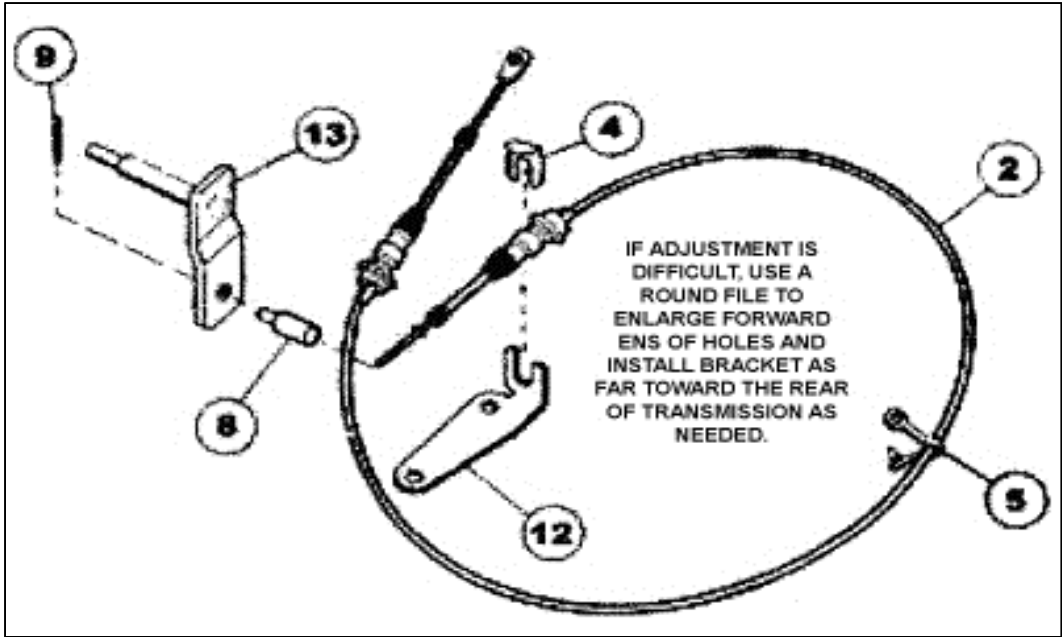

Neutral/Park Start Safety Switch Electrical Wiring Instructions

1. Vehicle must have engine off, parking brake securely engaged, wheels blocked, with transmission and shifter in the neutral position before attempting switch wiring hookup.
2. Install the supplied female crimp terminals to two suitable lengths of wire, use at least 16 gauge wire for this installation.
3. Plug each female connector onto the spade terminals of the micro switch located in the plastic switch housing.
4. Using the wiring diagram below as a guideline, install the switch wires into your starting circuit.
5. With shifter and transmission in neutral, check to see that engine starts. Repeat this with the shifter and transmission in the park position. If necessary, loosen the screw on the adjusting collar located near the shifter handle and adjust slide mechanism back and forth until vehicle starts in neutral and park only.

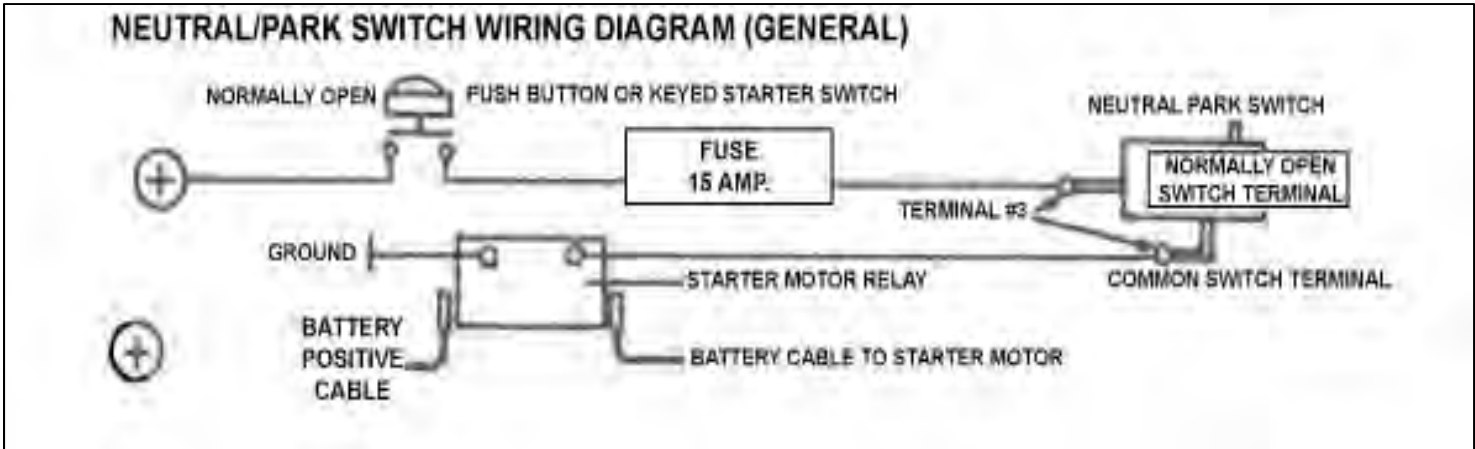

TO CONVERT FROM 2-SPEED POWERGLIDE TO 3-SPEED TURBO, OR VICE-VERSA

Quarter Stick® Shifters are set up for 2-speed (Powerglide) from the factory, but with the following modification procedure your shifter will be ready to use on a 3-speed (Turbo Hydramatic). **Note where small shims and thread sealant are used, this is important for free movement of the Reverse Lock-out Lever.**

1. Place shifter lever all the way forward to PARK position, for easy access to socket screw.
2. Insert 3/32" hex key into #8 flat head socket screw and hold while removing #8-32 self-locking hex nut with an 11/32" wrench.
3. If necessary, loosen 1/4-28 button head screw with 5/32" hex key to swing retainer plate upward for access to block adapter.
4. Remove the block adapter, put #8 flat head socket screw back through hole and put small spacer on screw.

NOTE: There may be a small shim to put in between spacer and retainer plate.

5. Place retainer place back in position. Put flatwasher and #8-32 self-locking nut on and tighten.
6. If 1/4-28 button head screw has been loosened, back it out no more than 3 turns and put thread sealant on the threads of the plate. Be extremely careful not to remove this screw completely as there are internal shims that must stay aligned. Retighten, but the Reverse Lock-out lever must move freely.

IMPORTANT: See Page 2 for correct bracket and Trans-arm for Turbo Hydramatic installation.

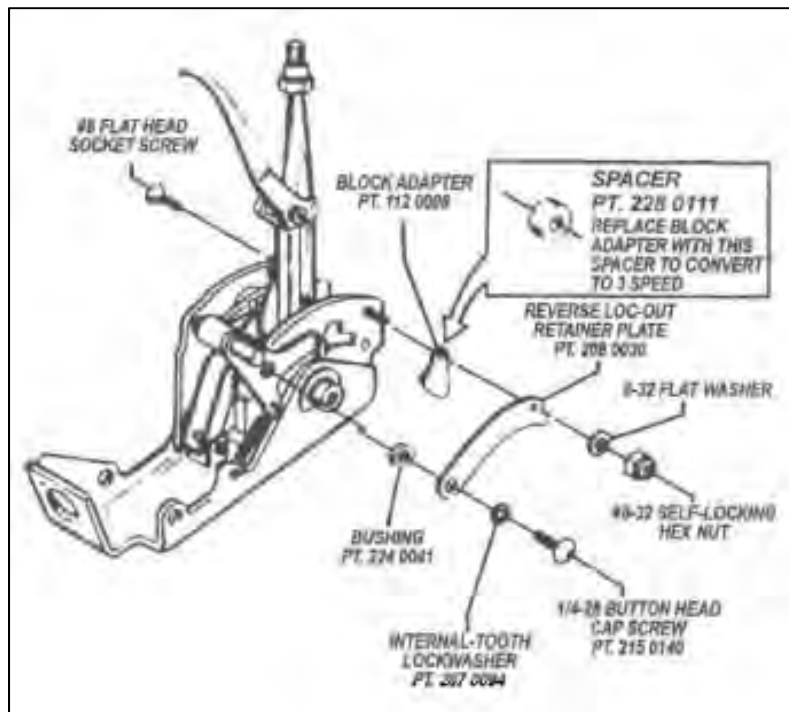

Pistol-Grip Roll/Control Switch

The Pistol-Grip Quarter Stick® shifters come equipped with a precision, snap-action, 12 volt switch that is ideal for operating the Hurst Roll/Control, nitrous oxide systems, trans. brakes, etc. It is a normally open, momentary contact, quick release switch with a maximum 10 amp. rating.

CONTENTS OF KIT

<u>DESCRIPTION</u>	<u>PART NO.</u>
Shifter Assembly	
Cable	5000025
Cotter Pin(3/32" x 3/4")	1900001
Cable Attachment Clip	1275702 (2)
Cable Support Clamp	1260013 (2)
1/4" x 1" Self-Tapping Hex/ Head Sheet Metal Screw	2725699 (4)
1/4" Flatwasher	2673478 (4)
Cable Pivot	1940005
Cotter Pin (1/16" x 1")	97093086
Wire Terminal	2527600 (2)
5/16-18 x 3/4" Socket Head Cap Screw	2150018

Powerglide Application Only (2SPEED)

<u>DESCRIPTION</u>	<u>PART NO.</u>
Bracket-Transmission Cable	1170095
Arm and Shaft Assembly	10500084

Turbo-Hydrumatic Application Only (3 Speed)

<u>DESCRIPTION</u>	<u>PART NO.</u>
Bracket-Transmission Cable	1174778
Arm and Shaft Assembly	10500080

Hardware Kit (1540197)

<u>DESCRIPTION</u>	<u>PART NO.</u>
2280111 Spacer	2280111

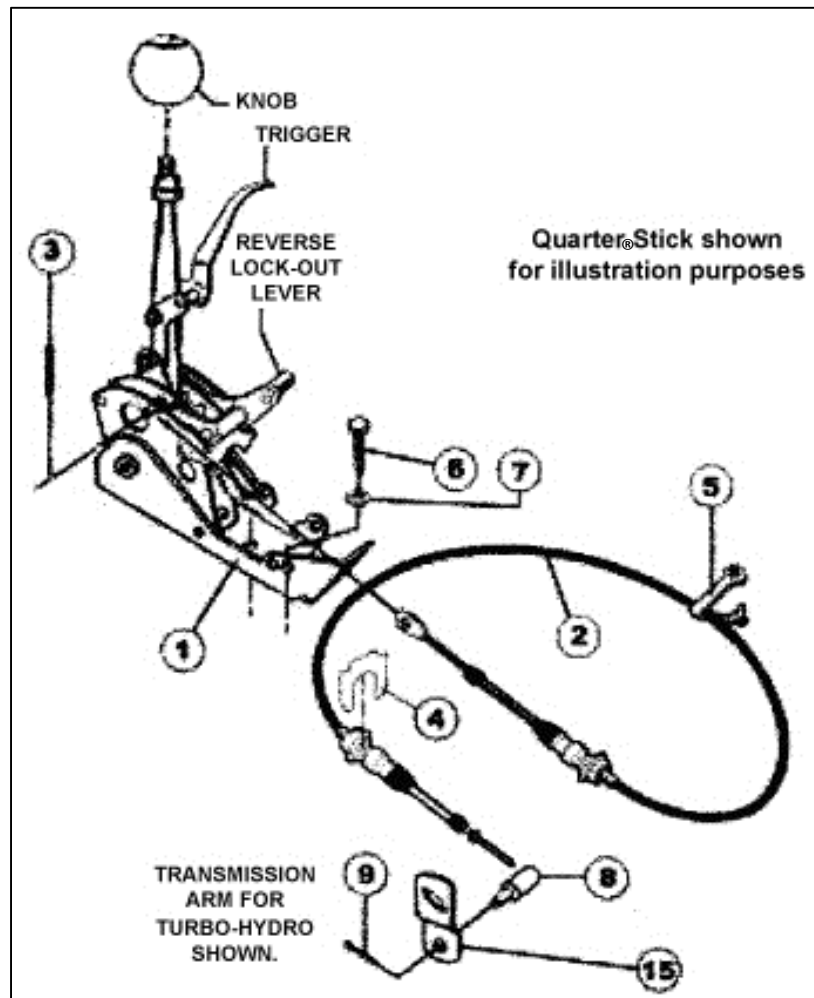

You may also purchase the optional Hurst Quick Release Aluminum Mounting Plate, P/N 1950225, which adds a professional look and allows easy removal. For a finished look, Hurst also offers an attractive Aluminum Cover Kit, P/N 1300041, as well as a Plastic Cover, P/N 1300055.

IMPORTANT: RETAIN THESE INSTRUCTIONS FOR FUTURE REFERENCE

Technical Service

A highly trained technical service department is maintained by Hurst Performance to answer your technical questions, provide additional product information and offer various recommendations.

Technical service calls, correspondence, and warranty questions should be directed to:



Hurst Performance Products

(707) 544-4761

www.Hurst-Shifters.com