

Edelbrock Supercharger

2017-19 CHEVY COLORADO, GMC CANYON 3.6L HFV6

Part #1518, 15180

Edelbrock[®]

SUPERCHARGERS



WARNING!

The supercharger bypass valve is factory installed and adjusted intended to be vacuum operated only. DO NOT move the solenoid actuator lever by hand or adjust the stop point. Moving the lever manually will damage the solenoid and the system will not function properly. Damage to the bypass assembly from manual movement will not be covered under manufacture warranty.



Edelbrock Supercharger System
2017-19 Chevy Colorado, GMC Canyon
3.6L HFV6
Installation Instructions

INTRODUCTION

Thank you for purchasing the Edelbrock Supercharger for the Chevy Colorado/GMC Canyon. This Edelbrock Supercharger System utilizes Eaton's R1740 TVS Supercharger rotors housed inside a redesigned supercharger manifold. The manifold is Edelbrock's most advanced supercharger design to date and fits under the factory hood with no modifications. The supercharger retains a "blow-down" orientation which expels air downward through the intercooler core. Air pressure then builds in the plenum before being forced down through the intercooler resulting in incredibly low IATs to support more power.

The supercharger is 50-State emissions legal, and includes a 3-year 36,000 mile warranty when applicable

Installation time: Approximately 8 hours.

TOOLS AND SUPPLIES REQUIRED

- Ratchet and Socket Set including but not limited to: 7mm, 8mm, 10mm (standard, deep and swivel), 11mm, 12mm, 13mm, 14mm, 15mm, 18mm, 21mm, 24mm
- Wrench Set including but not limited to: 8mm, 10mm, 15mm
- Compressed Air
- Power Drill
- Drill Bit: 1.75" Hole Saw
- Torx Drives: T15, T25, T30
- Panel Puller
- Razor Blade
- Flat Blade & Phillips Screwdrivers
- Coolant Drain Bucket
- 50/50 Coolant Mixture
- Side Cutters
- Torque Wrench
- Pliers OR Hose Clamp Removal Tool
- Blue Thread Retaining Compound
- O-ring Lube
- Masking Tape
- Shop Rags
- Non-Black Sharpie or equivalent
- Wire Ties



Edelbrock Supercharger System
2017-19 Chevy Colorado, GMC Canyon
3.6L HFV6
Installation Instructions

IMPORTANT WARNINGS

Before beginning the installation, use the enclosed checklist to verify that all components are present in the box. Then inspect each component for damage that may have occurred in transit. If any parts are missing or damaged, contact Edelbrock Technical Support (800-416-8628), not your parts distributor.



WARNING: Installation of this supercharger will result in a significant change to the performance characteristics of your vehicle. It is highly recommended that you take some time to familiarize yourself with the added power and how it's delivered. This must be done in a controlled environment. Take extra care on wet and slippery roads as the rear tires will be more likely to lose traction with the added power. It is never recommended to turn off your vehicles traction control system.

Proper installation is the responsibility of the installer. Improper installation will void all manufacture's standard warranties and may result in poor performance and engine or vehicle damage. Inspect all components for damage that may have occurred in transit before beginning installation. If any parts are missing or damaged, contact Edelbrock Technical Support, not your parts distributor.

Due to the complexity of the Edelbrock Supercharging system, it is recommended that this system only be installed by a qualified professional with access to a service lift, pneumatic tools, and a strong familiarity with automotive service procedures. To qualify for the drivetrain warranty, it is necessary to have this system installed by a Certified ASE Technician at a licensed business, GM Dealership, or an Authorized Edelbrock Installer. Failure to do so will void and/or disqualify any and all optional supplemental warranties offered with this system. Please contact the Edelbrock Technical Support department if you have any questions regarding this system and/or how your installer of choice will affect any warranty coverage for which your vehicle may qualify.

Any previously installed aftermarket tuning equipment must be removed and the vehicle returned to an as-stock condition before installing the supercharger.

Any equipment that directly modifies the fuel mixture or ignition timing of the engine can cause severe engine damage if used in conjunction with the Edelbrock Supercharger System. This includes, but is not limited to: OBDII programmers, MAF sensors, adapters and any other device that modifies signals to and/or from the ECU. Aftermarket bolt-on equipment such as underdrive pulleys or air intake kits will also conflict with the operation of the supercharger and must be removed prior to installation. Use of any of these products with the Supercharger could result in severe engine damage.



**Edelbrock Supercharger System
2017-19 Chevy Colorado, GMC Canyon
3.6L HFV6
Installation Instructions**

IMPORTANT WARNINGS CONT'D



91 octane or higher gasoline is required at all times. If your vehicle has been filled with anything less, it must be run until almost dry and refilled with 91 or higher octane gasoline twice prior to installation.

Any failures associated with not using premium 91 octane gasoline or higher, will be ineligible for warranty repairs.

It is recommended that you check the Edelbrock Tech Center Website for any updates to this installation manual. Please refer to the lower right hand corner to verify that you have the latest revision of this installation manual before beginning the installation.

Tech Center: http://www.edelbrock.com/automotive_new/misc/tech_center/install/index.php



WARNING: Installation of this supercharger and charge air cooler may require removal and replacement of front grille, front bumpers, or other pieces which may be equipped with Advanced Driver Assistance Systems (ADAS). ADAS Systems include, without limitation:

- Forward Collision Warning
- Auto braking
- Lane Departure Warning
- Lane Keeping Assist
- Blind Spot Warning
- Rear Cross Traffic
- Rearview Camera
- And various other OEM ADAS Equipment

It is the responsibility of the installer to ensure that all necessary ADAS systems that require post-repair calibrations/targeting/aiming is performed by qualified repair facilities. Edelbrock assumes no liability whatsoever with respect to any damages or losses with respect to any ADAS systems.

Edelbrock Authorized Installer Disclaimer

Authorized installers of Edelbrock products are independent companies over which Edelbrock has no right of control. Edelbrock LLC makes no claims regarding the abilities, expertise or competency of individual employees of any authorized installer. Each authorized installer is an independent company and makes its own independent judgments. Edelbrock LLC specifically disclaims any responsibility to any party including third parties for the actions, or the failure to act, of individuals, agents or a company authorized in the installation of Edelbrock LLC products.

INSTALLATION HARDWARE IDENTIFICATION GUIDE

(Parts Are Not To Scale)

BAG #1 - FEAD HARDWARE				
Item	P/N	QTY.	Description	Torque Spec
1	36-0207	1	Bolt, Socket Head, M6 x 90mm	10 ft-lbs
2	36-3815	1	Bolt, Hex Flange, M8 x 90mm	18 ft-lbs
3	36-1518	1	Bolt, Socket Head, M8 x 30mm	18 ft-lbs
4	36-1544	1	Bolt, Socket Head, M6 x 45mm	10 ft-lbs
5	82-0120	1	Washer, M8, 24mm, 2.2mm	N/A

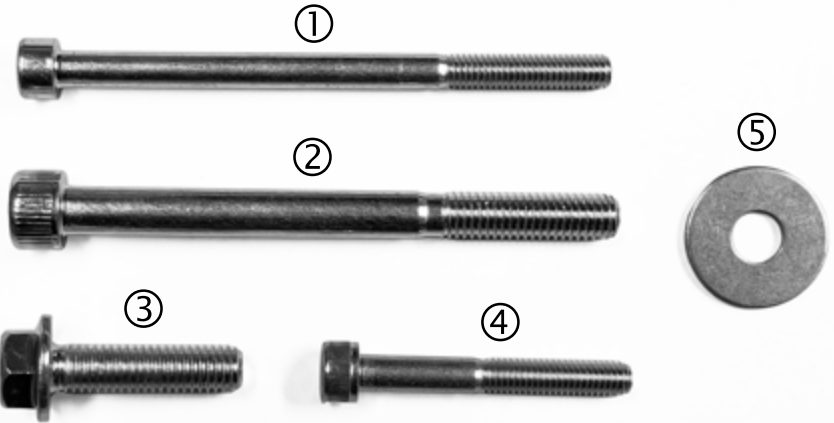

BAG #2 - INTERCOOLER HARDWARE			
Item	P/N	QTY.	Description
1	51-4601	1	Straight Connector, 3/4" to 3/4"
2	46-2155	10	Hose Clamp, 3/4"
3	36-1507	4	Bolt, Hex Flange, M6 x 16mm
4	36-1552	2	Bolt, Hex Flange, M6 X 10mm
5	24-1518	1	Water Pump Bracket Spacer

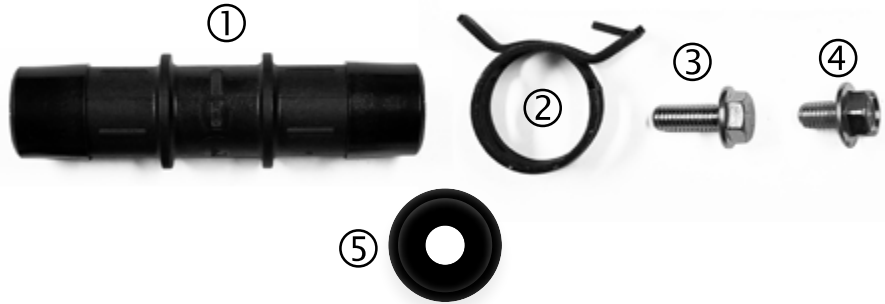

BAG #3 - MANIFOLD / RUNNER HARDWARE				
Item	P/N	QTY.	Description	Torque Spec
1	36-0042	7	Bolt, Socket Head, M8 x 65mm	18 ft-lbs
2	36-4045	1	Bolt, Hex Flange, M8 x 30mm	18 ft-lbs
3	36-1582	8	Bolt, Socket Head, M6 x 25mm	8 ft-lbs
4	36-4043	2	Bolt, Hex Flange, M6 x 16mm	10 ft-lbs
5	36-1528	1	Bolt, Socket Head, M6 x 16mm	8 ft-lbs
6	36-1507	1	Bolt, Hex Flange, M6 x 16mm	8 ft-lbs
7	82-4720	1	Washer, M6, 12mm x 1.5mm	N/A
8	85-1133	6	O-Ring, Intake Ports	N/A
9	72-4013	1	O-Ring, Throttle Body	N/A

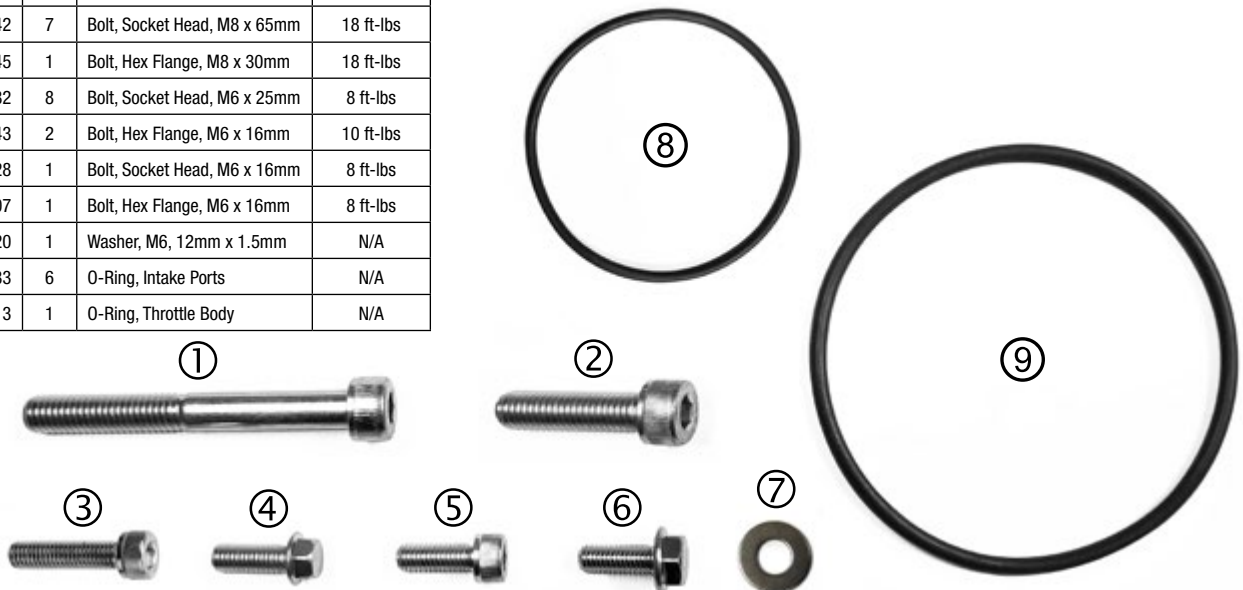

BRACKET AND FEAD IDENTIFICATION GUIDE
(Parts Are Not To Scale)

Item	P/N	QTY.	Description
1	24-15184	1	FEAD Bracket
2	51-4040	1	Idler, 76mm, Smooth
3	38-0223	1	Wire Harness Bracket
4	38-0269	1	Vacuum Pump Bracket
5	38-0252	1	Surge Tank Bracket
6	38-0253	1	Water Pump Bracket
7	38-0256	1	LTR Bracket, Right Upper
8	38-0268	1	LTR Bracket, Right Lower
9	38-0255	1	LTR Bracket, Left Lower
10	38-0254	1	LTR Bracket, Left Upper

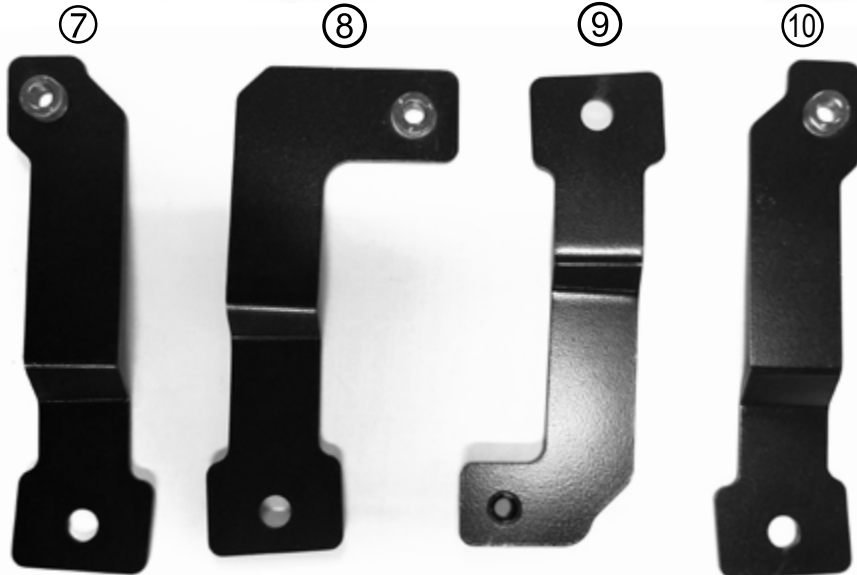
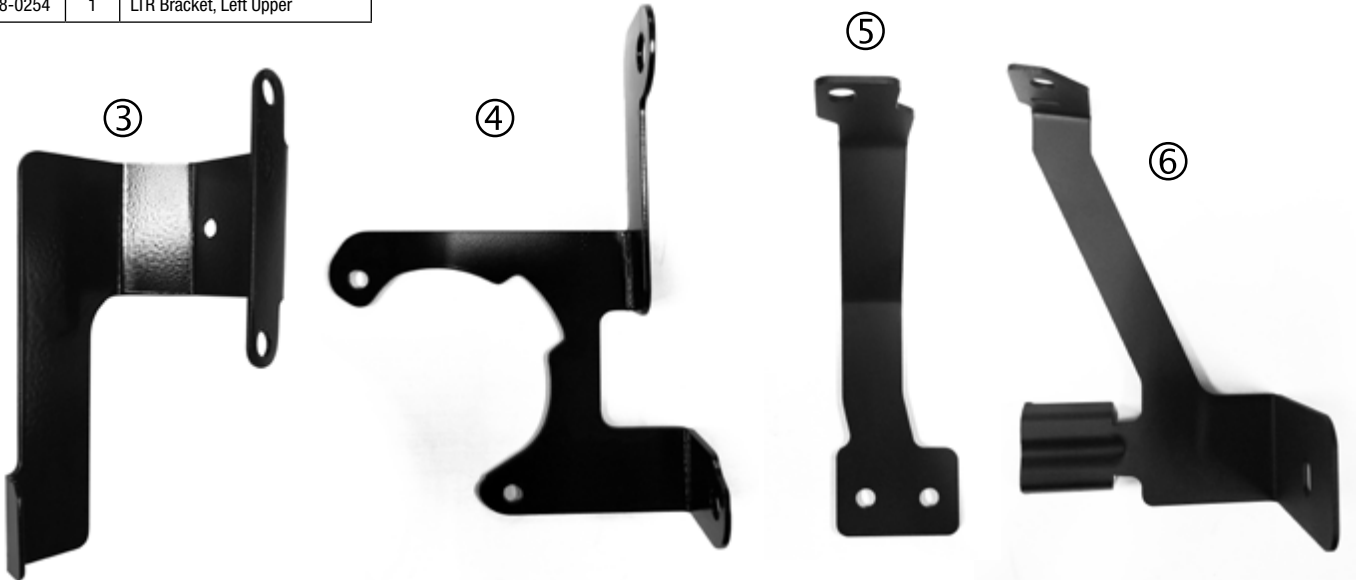

HOSE IDENTIFICATION GUIDE

(Parts Are Not To Scale)

Item	P/N	QTY.	Description
1	22-1499	1	EVAP Hose Extension
2	56-0018	1	Hose, LTR to Intercooler, Section B
3	56-0016	1	Hose, Water Pump to LTR
4	56-0017	1	Hose, LTR to Intercooler, Section A
5	56-0015	1	Hose, Surge Tank to Water Pump
6	56-0014	1	Hose, Intercooler to Surge Tank
7	22-1498	1	Brake Booster Hose Extension

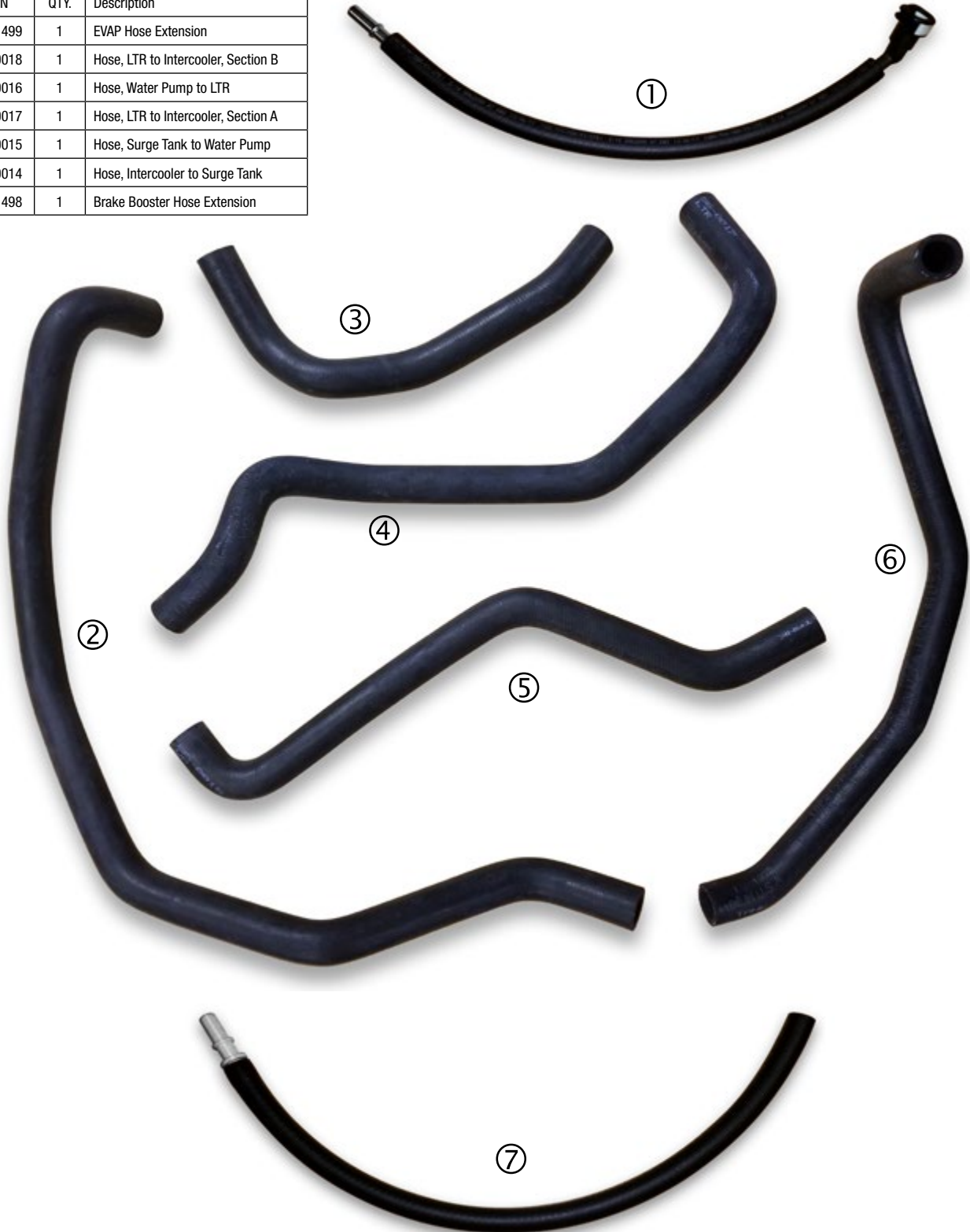

HOSE ROUTING DIAGRAM

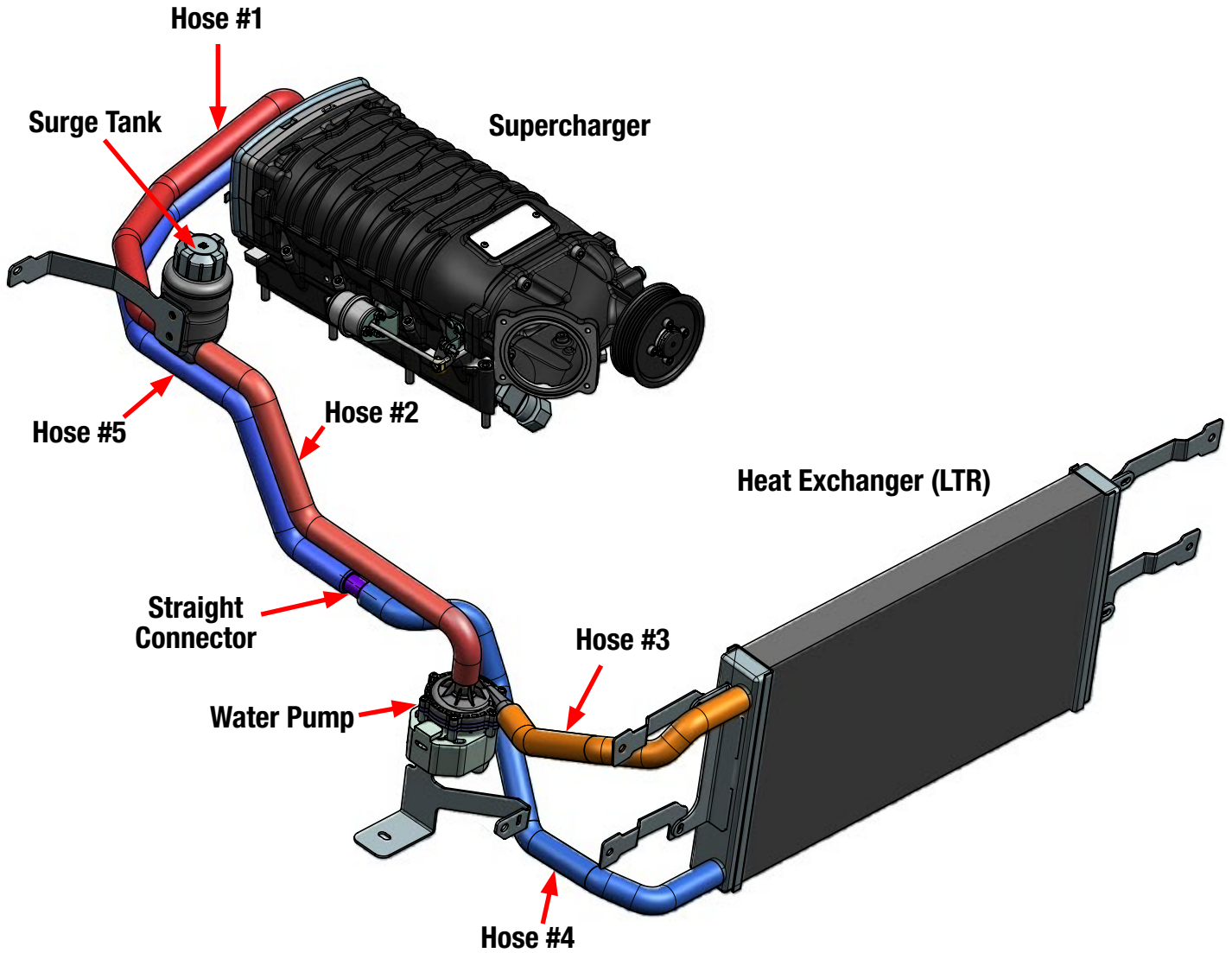

WIRE HARNESS GUIDE
(Parts Are Not To Scale)

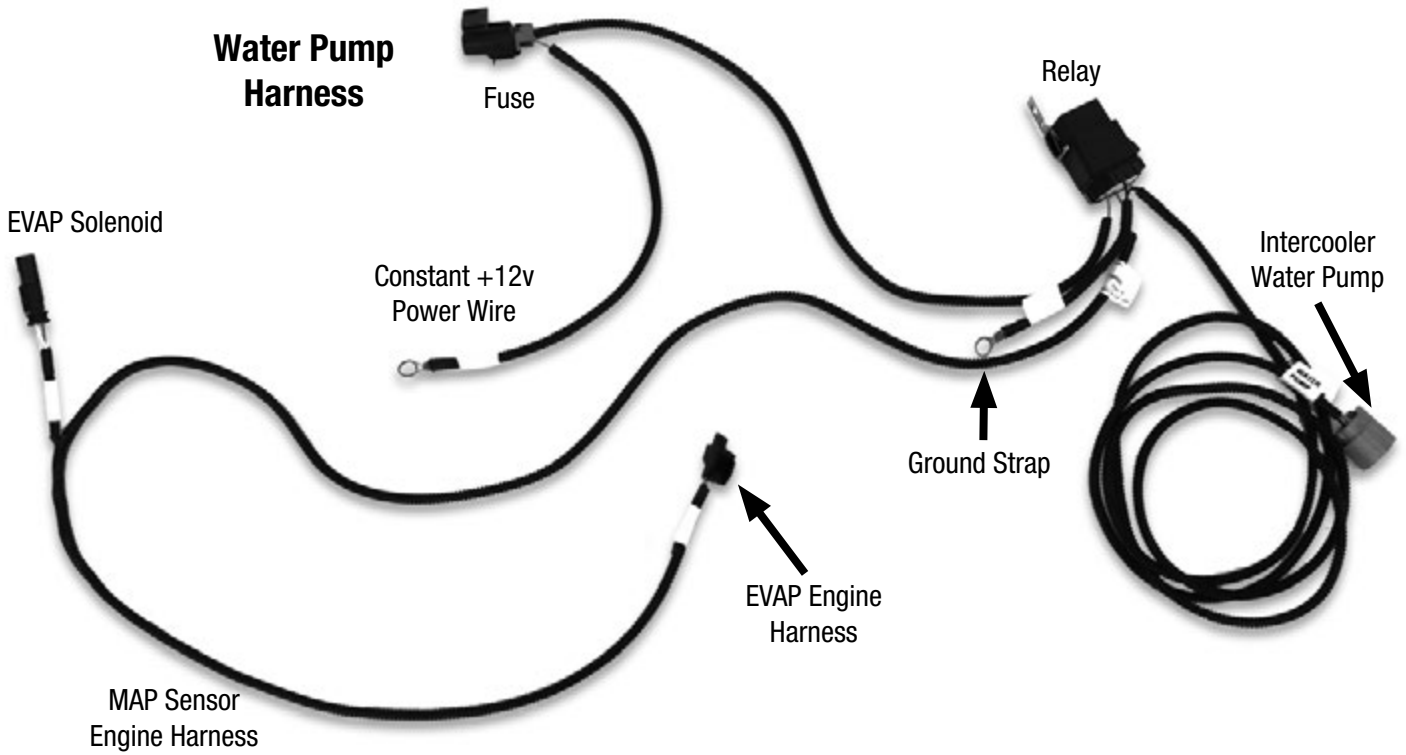

**Throttle Body ETC
 Harness Extension**

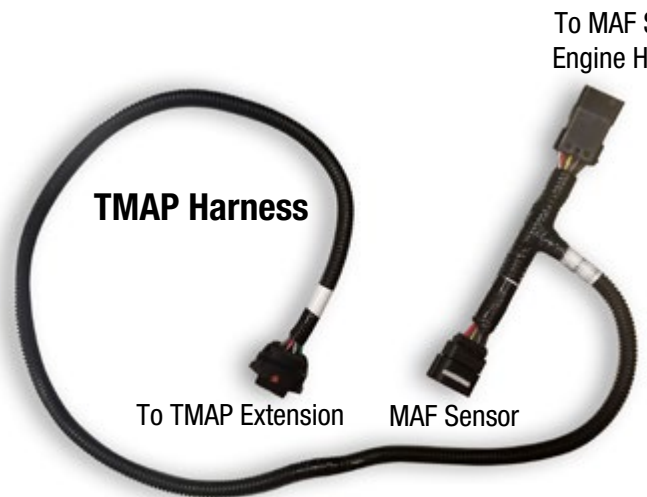

SUPERCHARGER INSTALLATION

WARNING: Battery must be sufficiently charged before starting the PCM flashing procedure.

1. Create a new registration, then download and install the latest RTD Flasher from: www.hptuners.com/myaccount/. Connect your RTD device to your PC via the supplied USB cable.

2. Open RTD Flasher, select HELP, and then resync interface.



3. Your RTD is now ready to use and will have four (4) credits pre-installed. With the RTD Flasher program still open, plug the RTD into your vehicles OBDII port and turn the ignition ON without starting the engine. Select the READ VEHICLE icon then click GATHER INFO in the VEHICLE READER box.

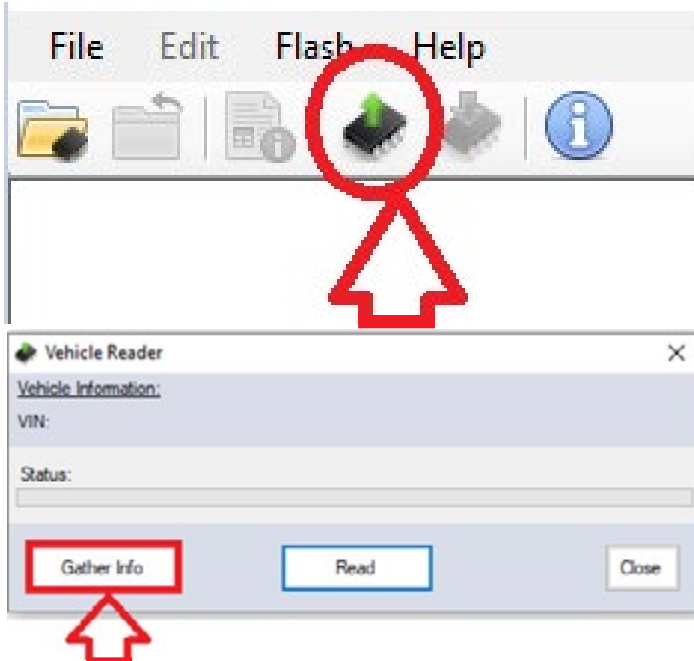

4. Under HARDWARE: T87A TCM, click the READ ENTIRE tab and change it to DO NOT READ.

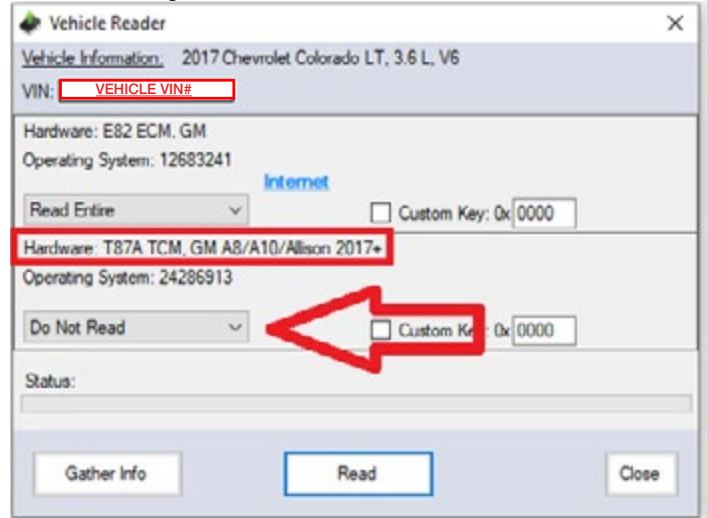

5. Select READ to begin uploading your stock ECM calibration. Follow the prompts to complete the read.

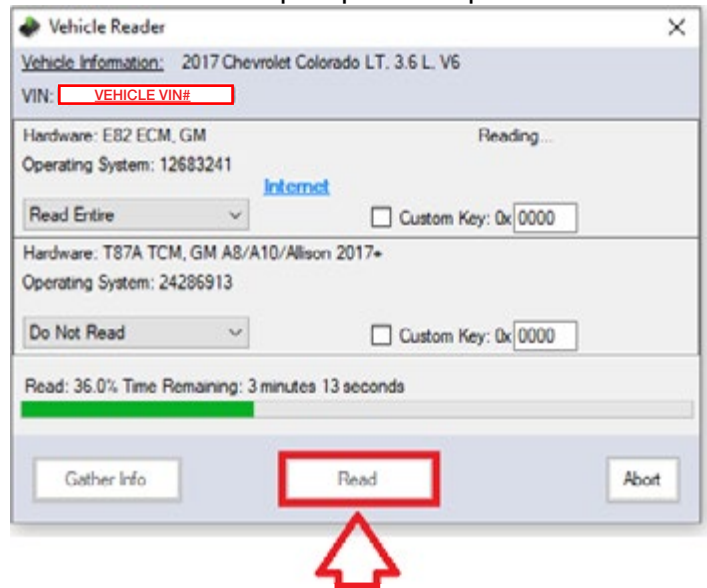

6. Once the stock read is saved to your PC, email the file to calibration@edelbrock.com titled "Calibration Update Needed, 20xx Colorado Supercharger Kit". Please allow up to 24hrs for your calibration update to be processed.

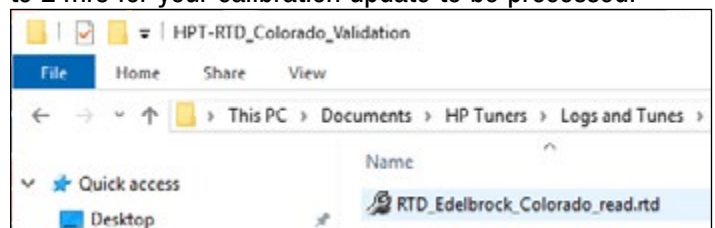

7. Once you receive the updated EFORCE file via email, save it to your PC. Open RTD Flasher, select FILE, OPEN, locate the updated EFORCE file you just saved to your PC, and double-click it to open.

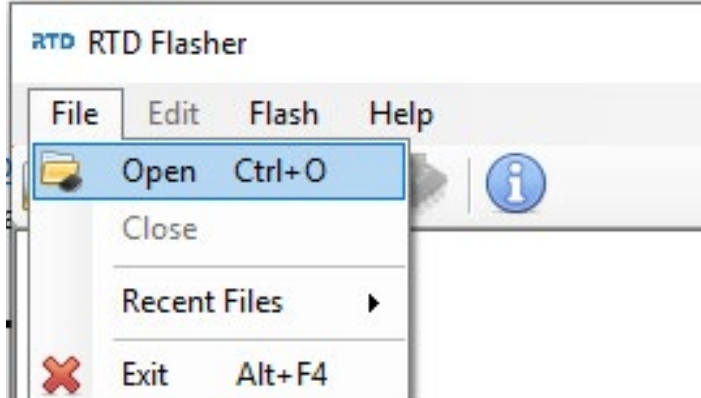

8. Select "SHOW LICENSE OPTIONS" at the bottom of the UNLICENSED FILE window.

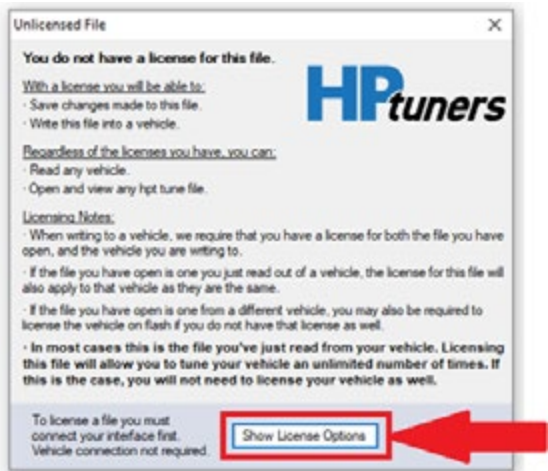

9. In the LICENSE SELECTOR window, select OK to apply the available credits for the EFORCE calibration.

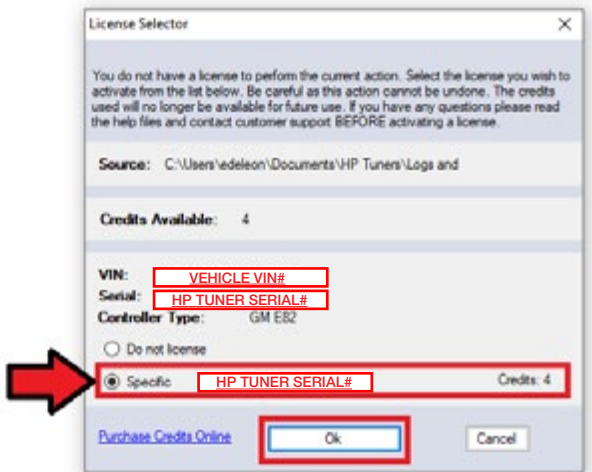

10. In the LICENSE SELECTOR CONFIRMATION window, select YES.

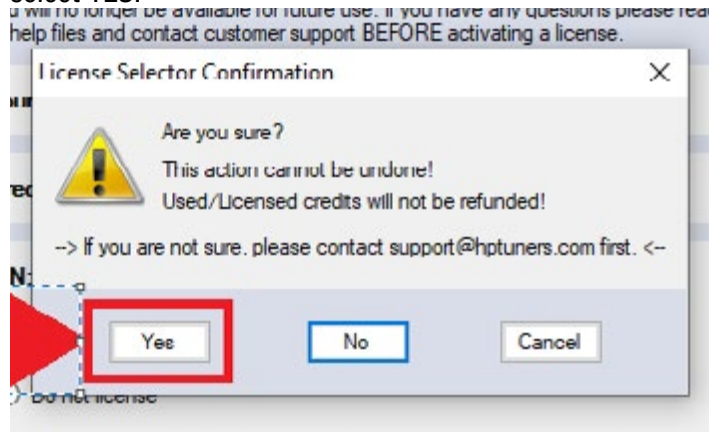

11. In the VEHICLE WRITER window, select WRITE to begin flashing the EFORCE calibration. Follow the prompts to complete the flash.

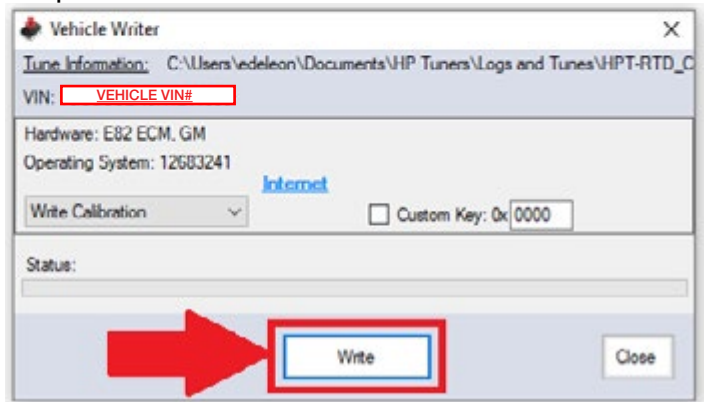

12. Once the flash is completed, click CLOSE, turn the ignition OFF and disconnect the RTD from your OBDII port. The engine is now ready to start once the supercharger installation is complete!

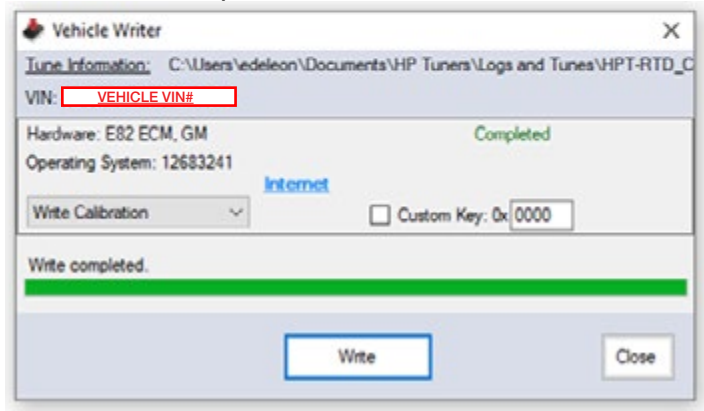

13. Open the hood and access the battery via the engine compartment on the driver side. Using a 10mm socket, disconnect the negative battery terminal. **Shield the connector from touching the battery terminal.**



14. Using a T15 screwdriver, remove all 6 screws on top of bumper cover.



15. Remove the T15 screws (6 on each side) that attach the inner fender to the bumper cover. Do this for each side. **NOTE:** ZR2 models will need an additional T15 removed.



16. Fold back the inner fenderwell. Using a 7mm ratchet, remove the 3 screws holding the fender to the bumper cover. Do this for each side.



17. Remove (2) 10mm bolts from the center of the grill. **NOTE:** They are deep inside and can be hard to see. Do this for each side. **NOTE:** ZR2 models have (4) 10mm bolts.



18. Using a 10mm socket, remove the bolt holding the bumper to the chassis bracket. Repeat for other side.

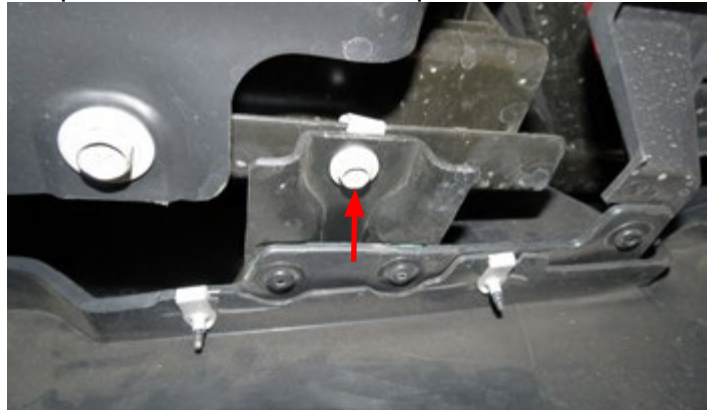

19. Remove the grill/bumper cover. Start in the middle and loosen the cover from the core support. Then, gently start pulling the bumper out and down, taking care not to break the plastic guide pins beneath the headlights. Unplug foglights if equipped.



20. Remove the grill seal from the shutter assembly by removing the plastic fasteners (green arrows) and then reach inside the housing, through the shutters, and pressing the 6 tabs (red arrows) until it is free. TIP: A short flat-head screwdriver helps in disengaging the tabs. **NOTE:** Some models may not be equipped with shutters.

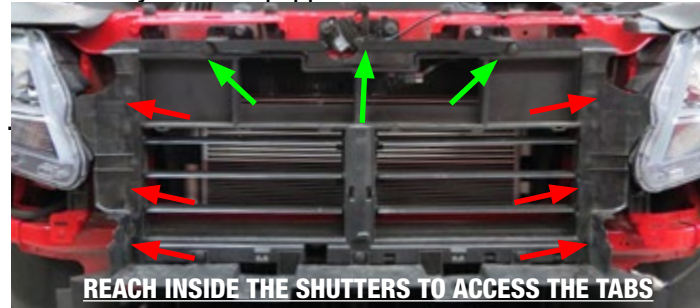

21. Using a 10mm, remove (9) bolts attaching the shutter assembly to the core support. Unplug the hood latch sensor (green arrow), unplug the shutter control cable (if equipped), and then remove the shutter assembly and set aside.

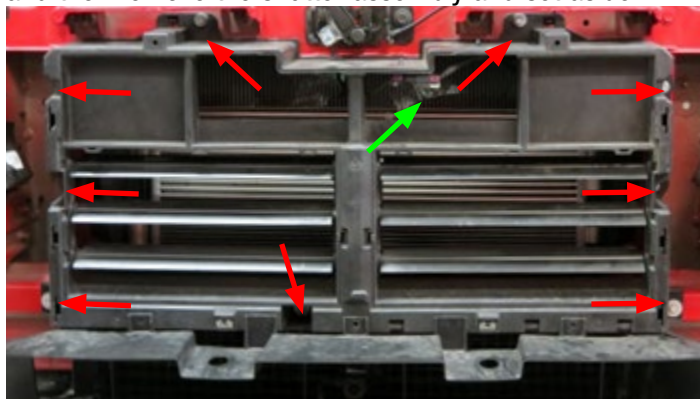

22. Carefully remove the plastic cowl on the passenger (right) side of the vehicle.

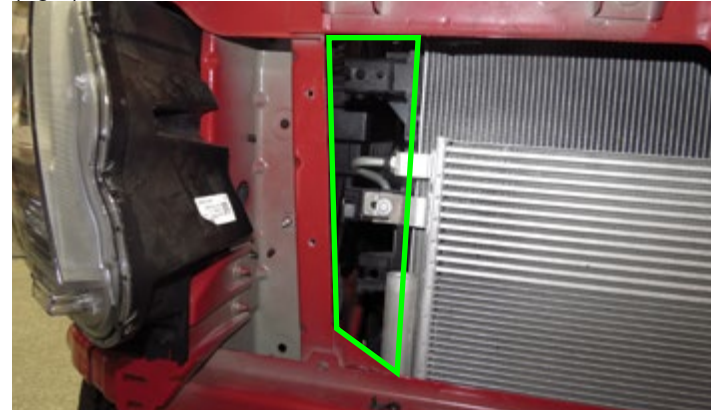

23. Trim the cowl as shown to clear the LTR hoses so they can pass through the core support.

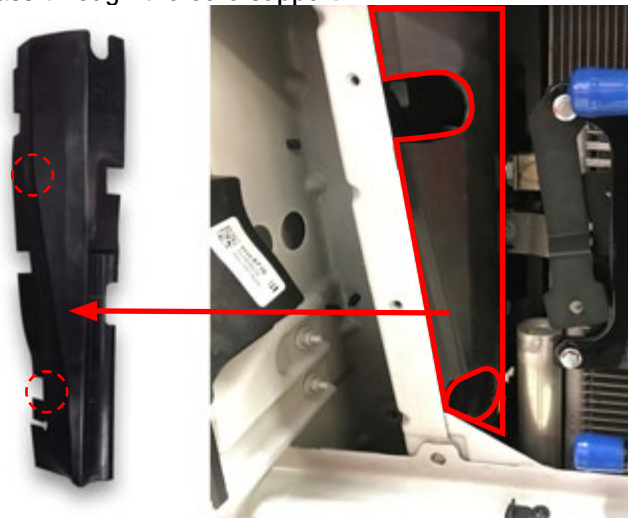

24. Reinstall the plastic cowl and install the LTR brackets (Shown in red) by reusing the bolts that were removed when uninstalling the shutters assembly. **NOTE:** PEM nuts face towards rear of vehicle.

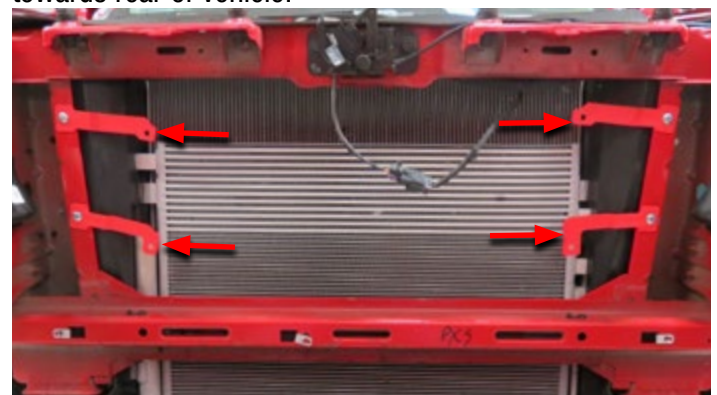

25. Install the Low Temp Radiator (LTR) to the brackets with the ports facing the passenger (right) side of the vehicle using the M6 x 16mm bolts from bag #2.

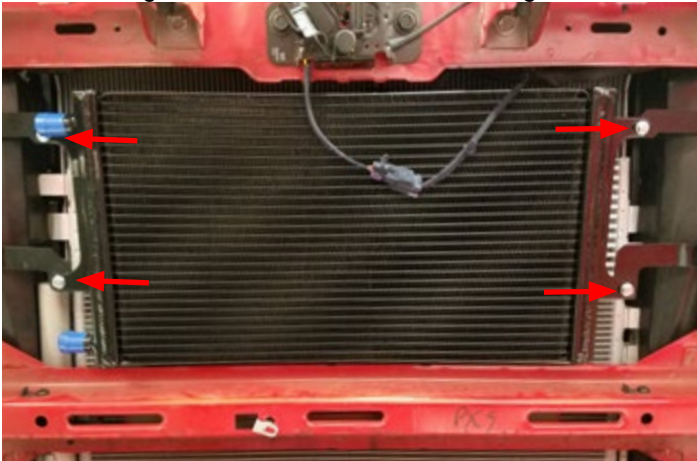

26. Pass hoses #3 and #4 through the new holes in the plastic cowl and install the hoses onto the LTR using the clamps provided in bag #2. TIP: It's easier to insert the hose from the front of the vehicle. NOTE: Install the supplied 4" pieces of convolute over the LTR hoses to help protect them from chafing.

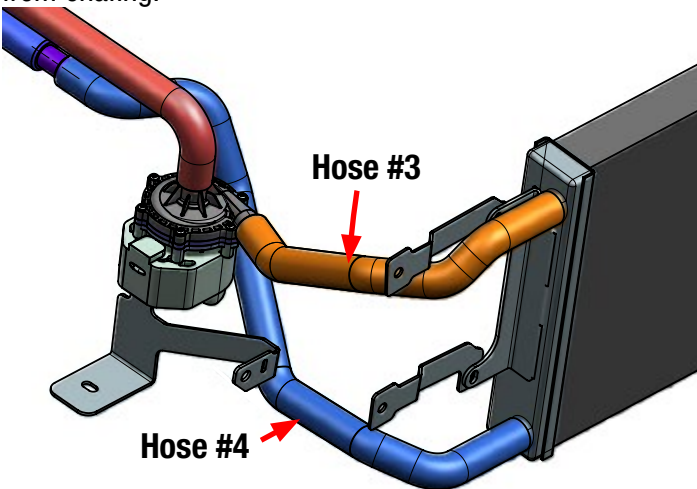

27. Remove the horn from the passenger side (right) front of the engine compartment using a 10mm socket. Unplug and set aside.

28. Undo the front 2 nuts holding the airbox onto the inner fender. Remove the rubber grommet from the airbox tab closest to the engine.

29. Place the water pump bracket underneath the airbox tab. With the supplied spacer, place the spacer underneath the airbox tab but on top of the water pump bracket. This spacer will replace the grommet that was removed. Replace both nuts and hand tighten.



30. Replace the horn back into the same position on top of the forward water pump bracket strut using the same bolt that was removed. Reconnect the plug.

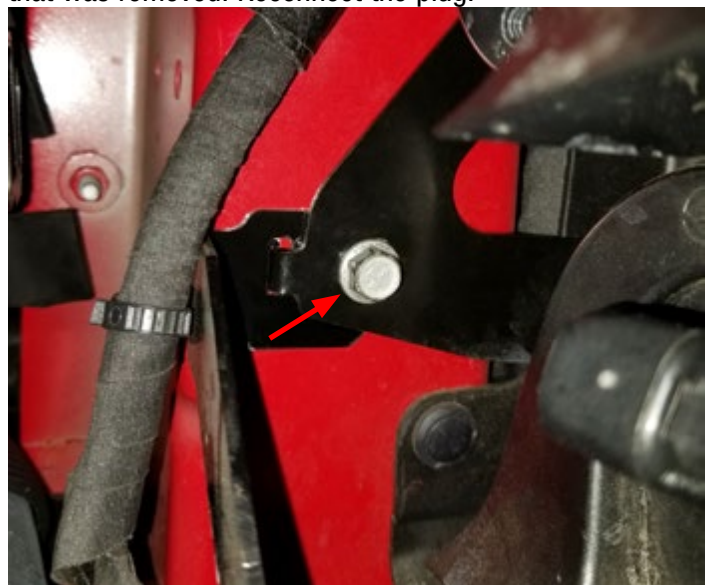

31. Place the rubber isolator onto the water pump with the slot facing away from the barbs. Connect hose #3 from the LTR to the output barb of the pump and secure with a hose clamp from bag #2. This barb should be pointing towards the front of the vehicle. Adjust the isolator as needed and slip the isolator onto the bracket as shown.

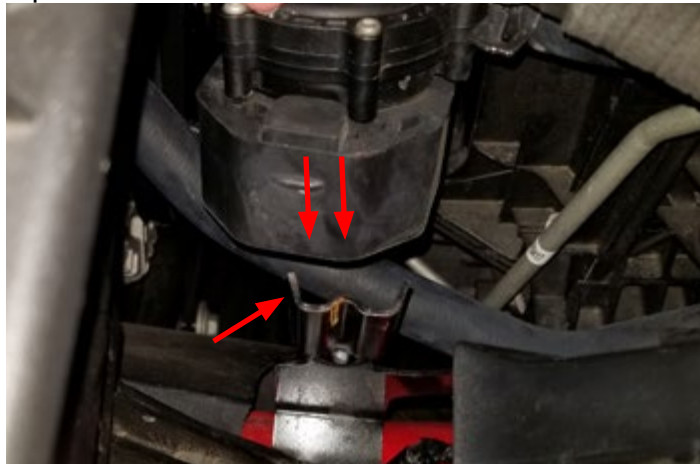

32. Disconnect the PCV hose and air intake from the engine cover.



33. Using a 10mm socket and a long extension, remove the 2 bolts holding the engine cover to the engine.



34. Using a 10mm socket, remove the bracket attaching the engine cover to the passenger side valve cover.



35. Remove the oil cap and set aside.



36. Disconnect the intake tube from the throttle body and lift the engine cover up. Disconnect the PCV hose from under the front right of the cover. The cover should be free now. Replace oil cap when finished.



37. Unplug the harness from the throttle body. Using a 10mm socket, remove the throttle body.



38. Using a T25 screwdriver, remove the MAP sensor and disconnect the cable. Set the MAP sensor aside. It will be reinstalled on the supercharger.



39. Disconnect the EVAP solenoid connections and then remove by using a 10mm socket as shown. This EVAP and bolt will be reused on the supercharger later.



40. Using an 13mm socket and extension, loosen the 8 captive bolts holding down the intake manifold.



41. Behind the intake manifold, there are two bolts attaching the intake to a steel bracket. Using a 10mm, remove these two bolts.



42. Underneath the throttle body flange, remove the 10mm bolt on the driver's side of the vehicle as pictured.



43. Once the manifold is removed, cover the intake ports to ensure nothing falls down into the ports.



44. Using a 13mm socket, remove the front engine cover bracket. Reinstall the original bolt in the passenger side.



45. Remove the factory timing cover bolts (pictured) and install the wire harness support bracket using the original bolts.



46. Using a 15mm socket, turn the tensioner counter-clockwise and remove the belt from the FEAD.



47. Disconnect the vacuum hose as pictured. Remove the bolts in the following picture and set aside. The bolts will be reused on the new bracket. The 13mm bolt has a nut on the opposite side. Be sure to recover this nut since it will be reused. Unplug and remove the vacuum assist pump and bracket from the front of the block, then remove pump from the OEM bracket.

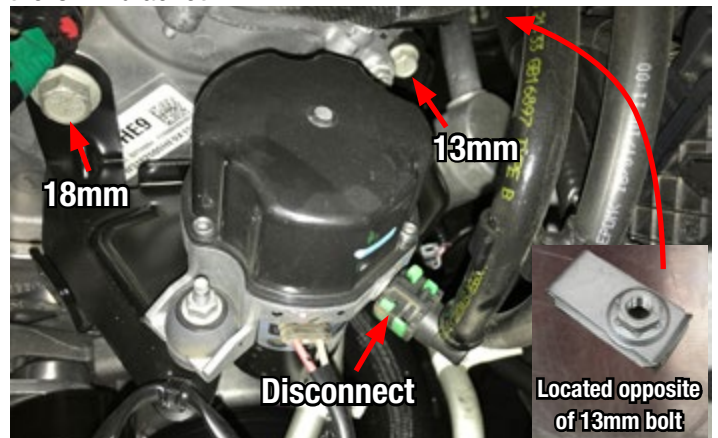

48. These 3 positions are where the new FEAD will be attaching. Remove the 2 timing cover bolts as pictured in green. The bolt circled in red was removed in step 44.

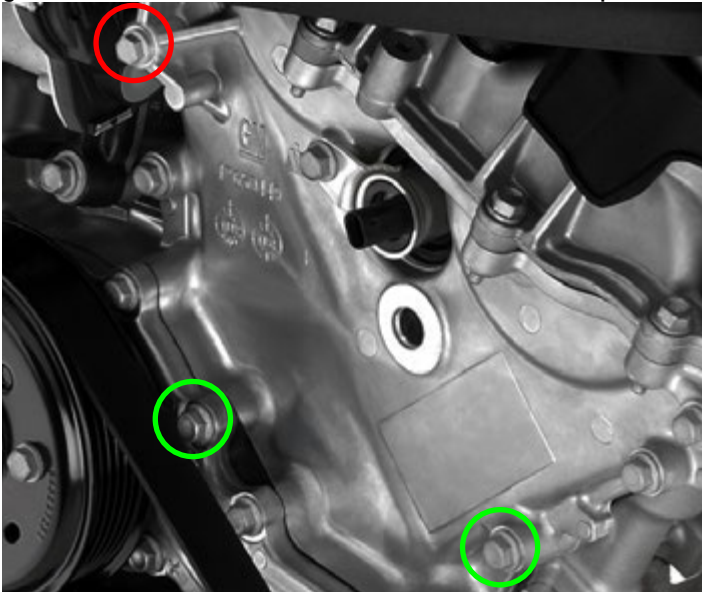

49. Attach the FEAD bracket and idler using the hardware provided in FEAD hardware bag #1 using blue Loctite.

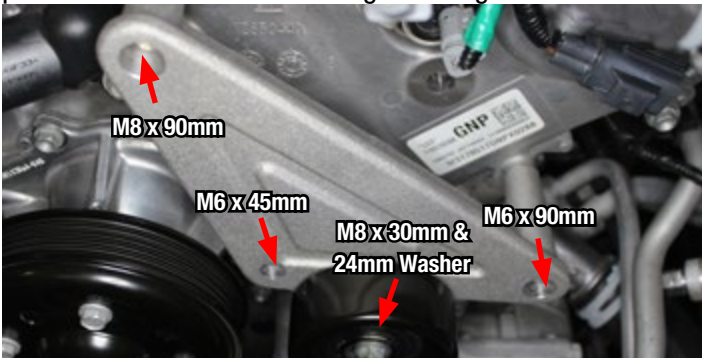

50. Attach the new vacuum pump bracket to the timing cover using the original bolt on the left side and original hardware on the right side. Reattach the pump on the new bracket and reattach all plugs and hoses.



51. The new TMAP sensor is pre-installed from Edelbrock. A TMAP extension cable is included. Once the intake is installed, the TMAP will be difficult to access.



52. Using O-ring lube, install all six O-rings from bag #3 into the intake manifold as pictured.



53. Remove the intake port covering. Clean the sealing surface and check for any stubborn dirt or debris before proceeding.



54. Before attaching the TMAP extension, feed the cable up underneath the factory lines as pictured. **NOTE: You must connect the TMAP extension before setting the intake down into the valley.**



55. From bag #3, use the (7) M8 x 65mm bolts, and the (1) M8 x 30mm intake bolt in the back. Apply Blue Loctite to all. **Use the following sequence to torque bolts 1 through 7 to 18 ft/lbs. Torque the #8 bolt (the short bolt) to 8 ft/lbs.** Damage to intake may occur if torqued incorrectly.

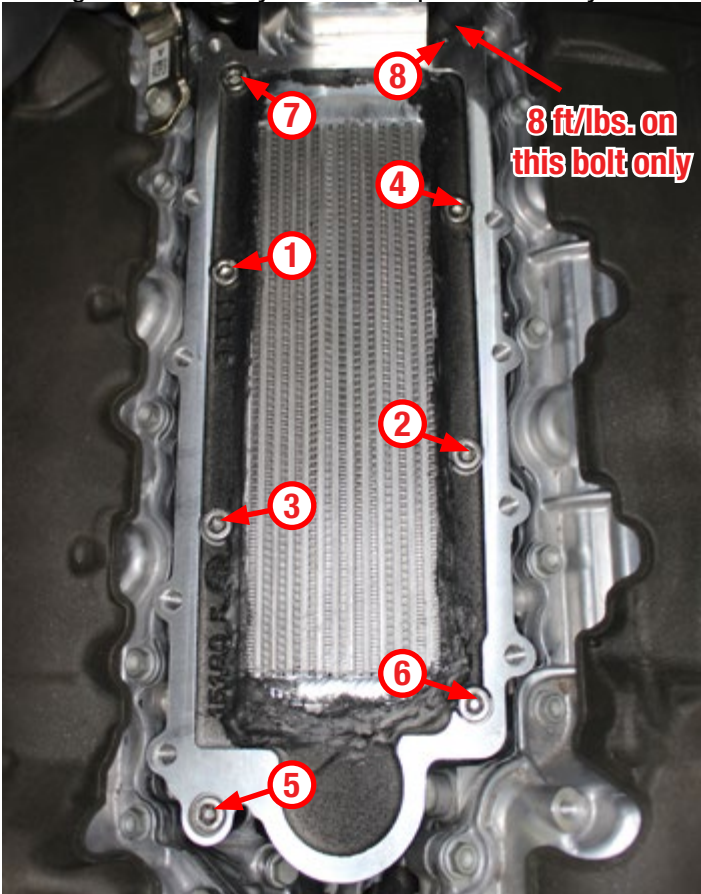

56. It is recommended to use copper sealant spray (or similar) on the bottom of the supercharger gasket to help keep it in place while positioning the supercharger.



57. Place the gasket on the intake manifold base. Be sure to align the gasket with the holes to ensure a perfect seal.

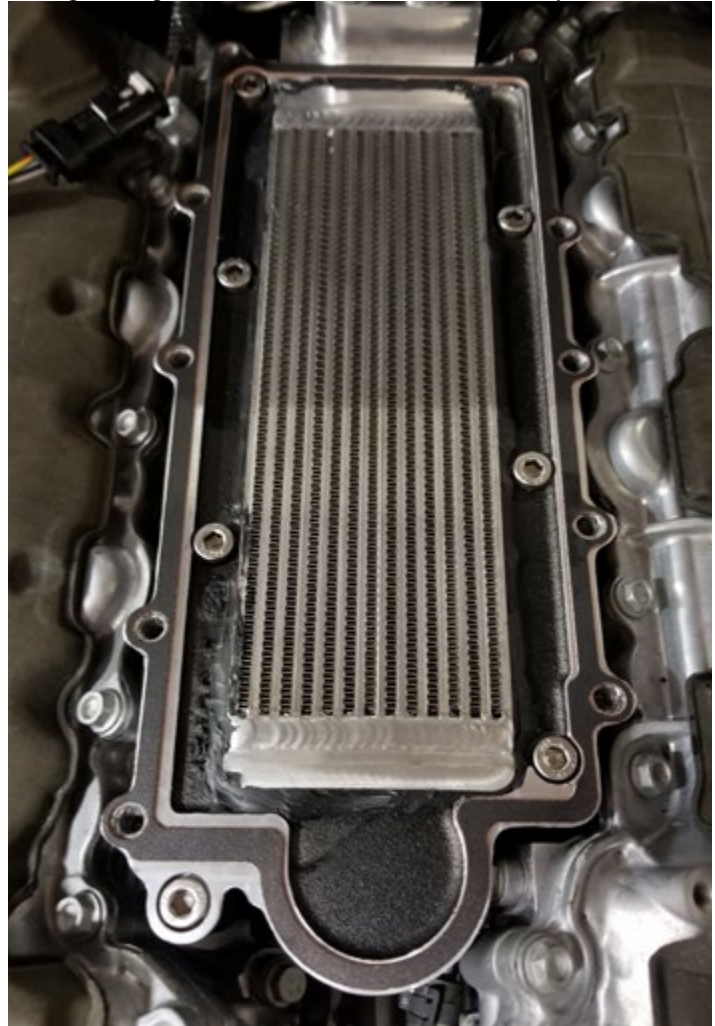

58. Install the factory MAP sensor to the underside of the supercharger nose using blue Loctite on the supplied M6x16 socket head bolt and M6 washer.



59. Using the supplied hose clamps from bag #1, attach the rear hoses to the supercharger's intercooler ports. Be sure hose clamps are pointed to the side to help clear the supercharger. Using the rest of the hose clamps, attach the surge tank as well as the water pump hose. Use the supplied fitting to connect Hose #5 to Hose #4 using clamps. Doing this step now helps ease installation.

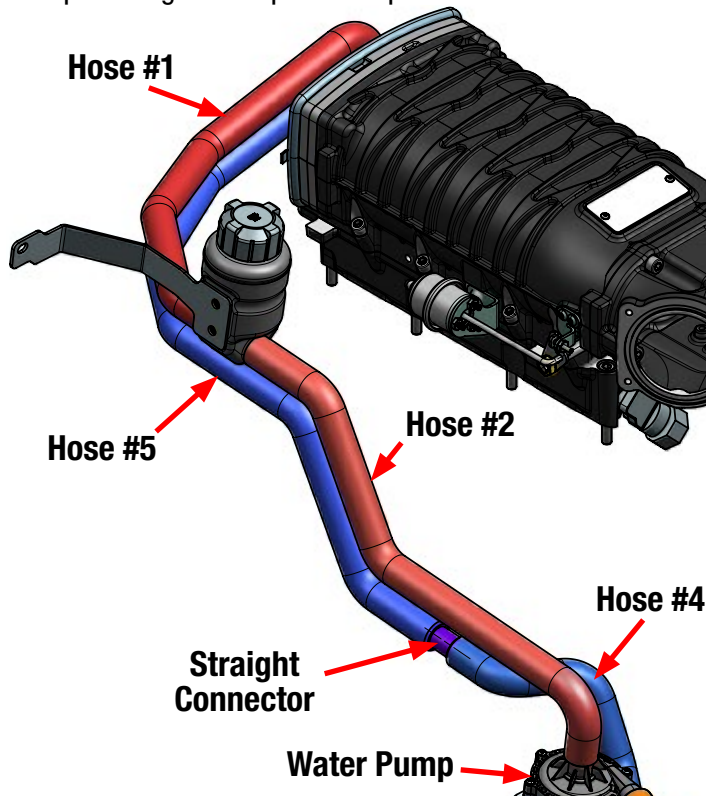

NOTE: Refer to the hose guide in the beginning of this manual to identify hoses.

60. Attach the surge tank bracket by removing the nut on the coolant tank and placing the bracket on the mount as shown here. Replace the nut. Use the 2 M6 x 10mm bolts from Bag #2 to attach the tank to the bracket.



61. Carefully place the supercharger unit onto the intake manifold, taking care not to damage the gasket. 2 people are recommended.



62. Place one of the supplied 4" convolute pieces over the lower LTR hose. This is to prevent chafing on the hose.



63. Using the hardware from bag #3, install the (8) M6 x 20mm on the sides, and (2) M6 x 16mm in the rear. Torque bolts 1 through 10 in the following order to 9lb/ft. (or 12Nm) of torque using blue Loctite. Install OEM MAP sensor behind the throttle body. **NOTE:** Do not over-torque.



64. Using the supplied serpentine belt, install the belt as pictured.

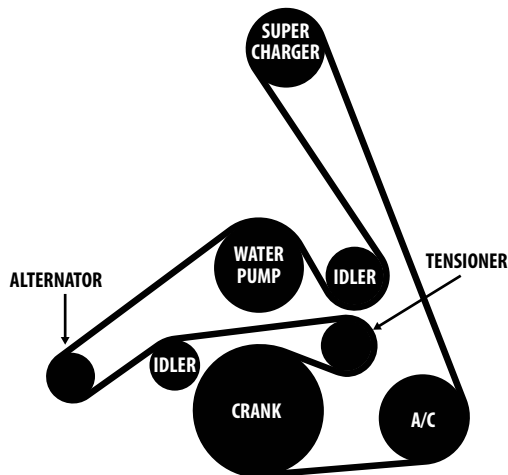

65. Plug in the MAP sensor underneath the nose.



66. Install the throttle body to the supercharger nose using the factory hardware and supplied O-ring. O-ring lube is recommended. Connect Throttle Body extension and the throttle body control cable.



67. Install the supplied Green air filter.



68. On the intake tube, insert the grommet and barb.

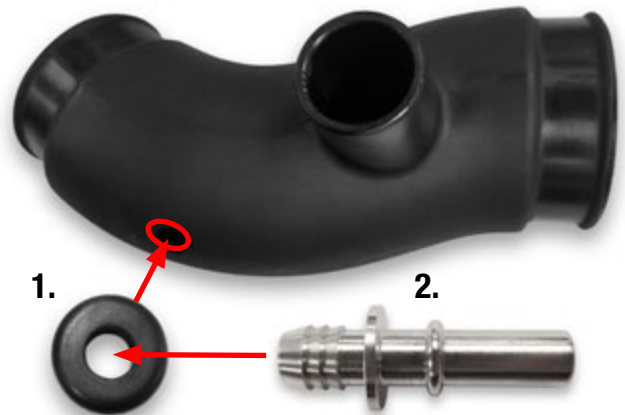

69. Install the intake tube using the supplied silicon couplers and hose clamps as shown here.



70. Reconnect the factory crank case ventilation hose to the bottom of the new intake tube.



71. Connect the PCV line to the fitting on the intake tube.

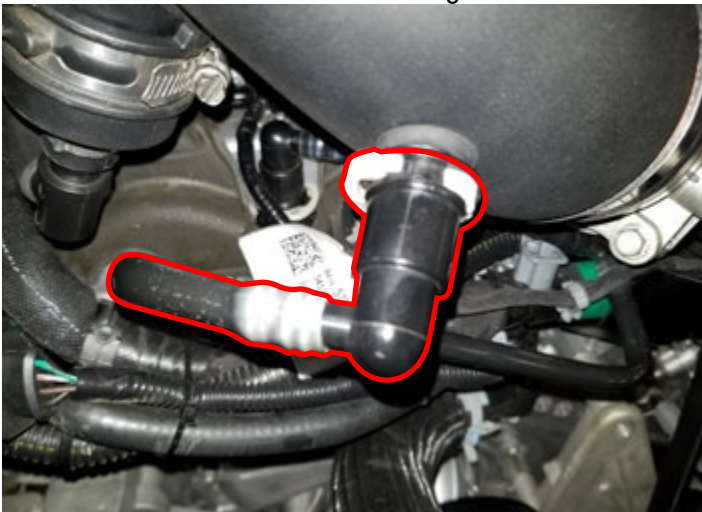

72. Unplug the MAF connector & attach the TMAP harness to the MAF. Reconnect the MAF sensor plug into the TMAP harness. Then connect the last plug into the TMAP extension located on the intake that was installed earlier.

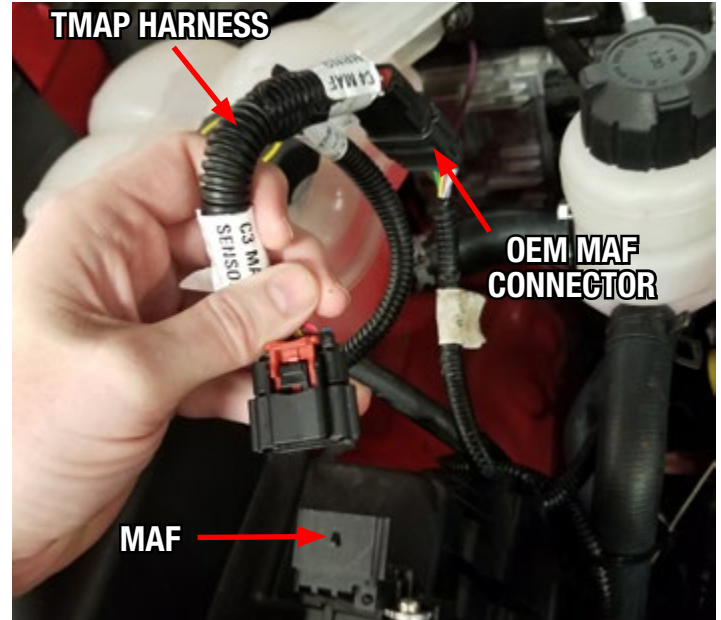

73. Using a 10mm socket, install the EVAP solenoid using the original bolt. Plug the supplied Water Pump Harness into the EVAP. Plug the other end into the original EVAP plug. Using hose #6 and hose #7 (page 13), connect the brake booster extension (Blue) and EVAP hose extension (Red). Connect MAP extension harness to the MAP Sensor located under the supercharger nose. Once finished, tuck wires opposite of the supercharger pulley onto the wire harness bracket and zip tie.

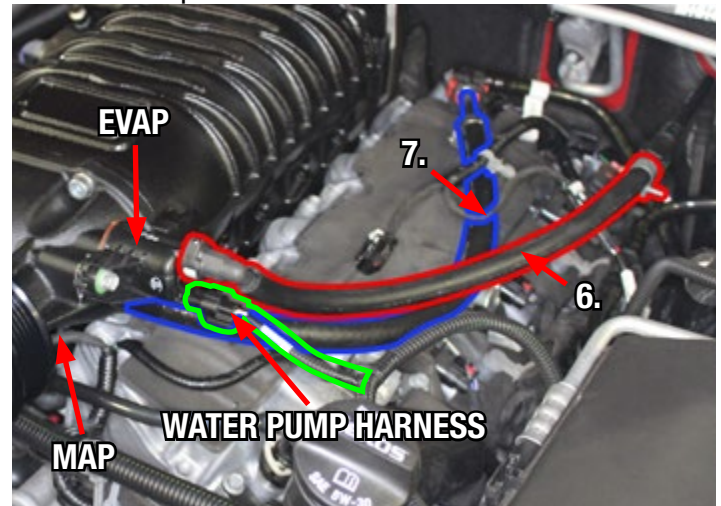

74. Install the 12 volt constant power lead on the Water Pump Harness as pictured here.

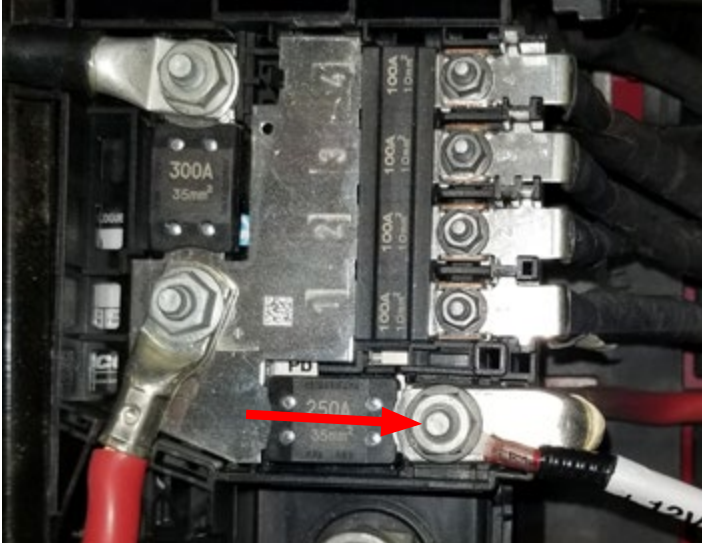

75. Remove the plastic panel on the driver's side fender by removing the three plastic push pins.



76. Remove the fender attachment bolt and secure the ground to the Water Pump Harness as pictured.



77. As you reinstall the panel, secure the relay by inserting the push-pin through the panel and then through the relay mounting tab.



78. Replace the grill shutters by unbolting the LTR buckets to the core support on one side only. Install the shutters back on and replace the bolts that were removed on that side. Once the grill shutters are tight on the one side, do the same for the other side. Doing this helps keep the LTR in place while you install the bolts. This makes it a lot easier to reinstall.

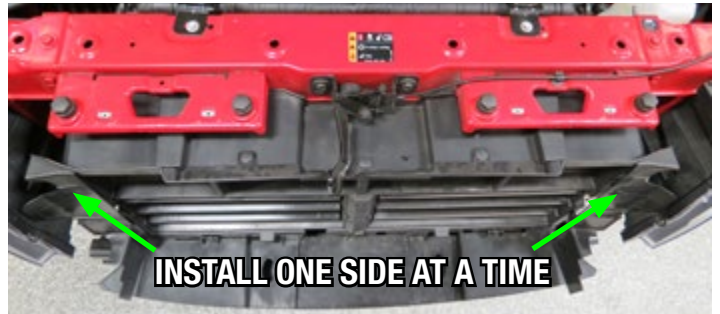

79. Reconnect the shutter cable. Reconnect the hood latch sensor. Reconnect the battery.

80. Fill the intercooler surge tank with 50/50 coolant. Once the air is mostly out of the tank, turn the key into the ON position but **DO NOT START**. Let the intercooler pump run to help bleed out any air pockets. This could take up to 20 minutes. Go to page 27 for more details on priming the intercooler.

81. To reinstall front fascia, follow steps 14-20 in reverse order.

How to Data Log with the RTD and VCM Scanner

1. In the event a data log of the vehicle needs to be recorded return to <https://www.hptuners.com/downloads/> and click on the DOWNLOAD VCM SUITE box. This will download HPT Tuners VCM Scanner software which will allow data logging and DTC reading/clearing.



2. With the RTD and PC connected to the vehicle and the ignition ON but engine OFF open VCM Scanner and select the CONNECT TO VEHICLE icon.

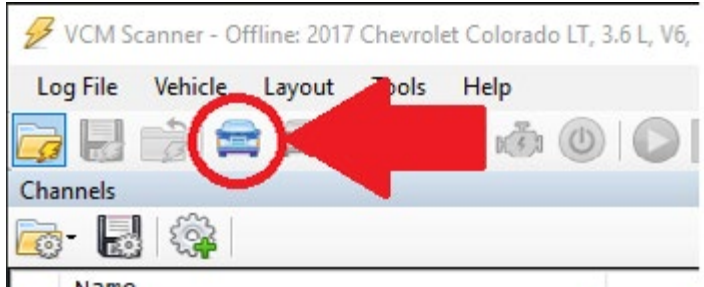

3. Once the connection is established select the RECENT CHANNEL CONFIGS icon then click LOAD SAE DEFAULTS. A basic list of parameters will appear

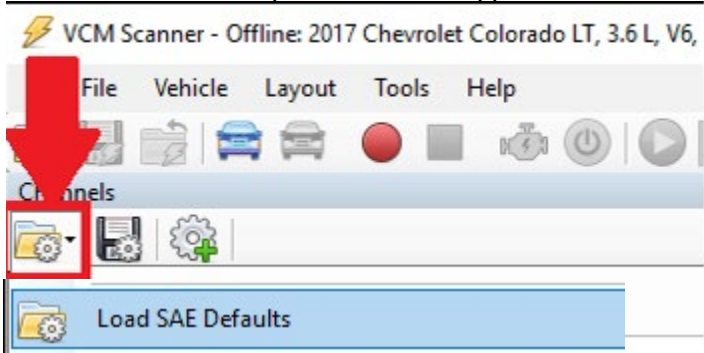

4. With the ignition still ON and engine still OFF click the START SCANNING icon to begin recording data.

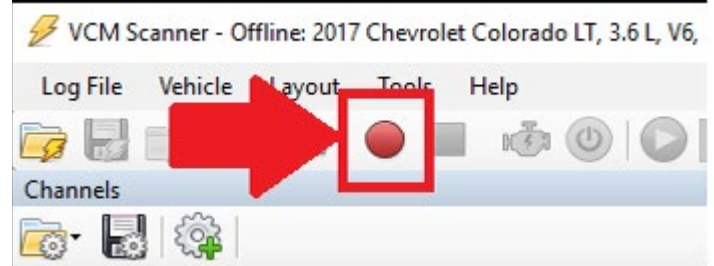

5. Once you have recorded the needed data, stop the vehicle in a safe location and click the DISCONNECT FROM VEHICLE icon.



6. To save the data log click the SAVE LOG FILE AS icon and name the file accordingly. Send the saved data log to calibration@edelbrock.com with a brief description of the scenario recorded and our calibration team will review the data as soon as possible.

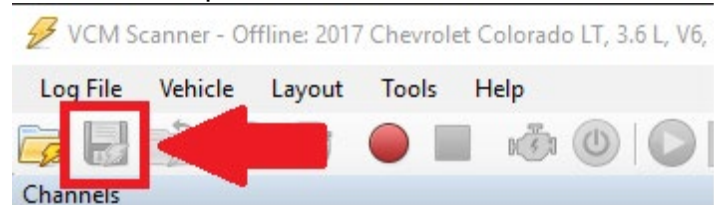

Congratulations on the successful installation of your new Edelbrock Supercharger System. If you have any questions, please call our Technical Support hotline at 800-416-8628 and one of our technicians will be happy to assist you.

CAUTION: Check ADAS sensors as described under the “Important Warning” section in the beginning of this document.

How to Prime the Edelbrock Intercooler Systems.



The electric water pump used on this Edelbrock Supercharger System has a built-in micro-processor that will vary pump cycle speed when air bubbles are present in the system. If a significant amount of air is trapped in the system, the pump may cycle at a slower speed and pulsations are likely to occur resulting in poor cooling performance.

For the best result, it is highly recommended to use a Radiator Cooling System Vacuum Purge and Refill Kit to properly evacuate the air from the intercooler system before filling with a 50/50 mixture of coolant and distilled water. If one is not available, the following procedure will be adequate.

1. Using the Lisle 24680 Spill-Free Funnel, or equivalent, secure the appropriate filler neck adapter to the surge tank.
2. Attach the funnel and fill with a 50/50 mixture of coolant and distilled water until the funnel is half full.
3. Turn the ignition to the ON position and listen for the pump's electric motor to cycle. Air bubbles will begin to purge from the system as the coolant level drops. Add coolant to the funnel as necessary. *NOTE: Do NOT let the coolant level in the funnel run empty as this may introduce air into the system.*
4. To build more pressure in the intercooler system, try squeezing the intercooler hoses while the pump is cycling. Building pressure in the system will help purge the trapped air from the intercooler system.
5. Cycle the ignition OFF and wait a few seconds for the pump to come to a stop.
6. Cycle the ignition ON again and repeat until the sound of the electric pump is continuous without any pulsation. *NOTE: During water pump start-up, it is normal for a slight pulsation to occur. Once the pump has reached its maximum cycle speed, no pulsations should be present.*
7. Periodically inspect the water pump flow after a few drive cycles and re-fill the intercooler system as necessary.
8. Several drive cycles may be required to completely purge the air from the intercooler system. During a drive cycle, the intercooler system will build up pressure as the supercharger temperature increases. Any residual air trapped in the system will gradually bleed out of the surge tank as the system reaches a pressure above 5psi.

WARNING: Always avoid removing the surge tank cap when the engine is hot. The hot coolant is under pressure and may spray out causing burns.