



## **Edelbrock E-Force Supercharger 2007-12, GM Trucks**

**Part # 1578 - 2007-12, 4.8/5.3L Silverado and Sierra**

**Part # 1579 - 2007-12, 6.0/6.2L Silverado and Sierra**





**Edelbrock Supercharger  
2007-12 GM Trucks; 4.8l, 5.3l 6.0l, 6.2l**

**Installation Instructions**

**E-MAIL EDELBROCK YOUR STOCK VEHICLE CALIBRATION AND VEHICLE INFORMATION**

**PLEASE COMPLETE THIS PROCEDURE PRIOR** to starting the installation of your E-Force supercharger system. This will allow our calibration team to complete your calibration file while the installation of your supercharger system is being completed. Manufacturers regularly update the factory calibration, as a result, there is the possibility for delays due to not having access to your current calibration file. This can normally be resolved in 1 business day.

**FAILURE TO PROVIDE ALL OF THE INFORMATION BELOW WILL DELAY THE COMPLETION OF THE CALIBRATION FILE FOR YOUR VEHICLE. TO LIMIT VEHICLE DOWN TIME, PLEASE SEND US THE REQUESTED INFORMATION BEFORE STARTING THE SUPERCHARGER INSTALL.**

Please e-mail the requested information below to [calibration@edelbrock.com](mailto:calibration@edelbrock.com) with the E-mail Subject as "Calibration Update". We will complete your calibration and e-mail it back to you as soon as possible. MOST calibration updates will be sent back the same business day. In rare cases, it could take up to 1-2 business days to complete. Please contact our Tech Hot Line at (800)416-8628 if you have any questions or if you need assistance with this procedure.

- Begin by downloading the SCT device updater software to your computer; it can be downloaded from: <http://www.sctflash.com/software/SCTDeviceUpdater.exe>
- Put the vehicle into ACC mode but do not start the engine.
- Connect the supplied PCM cable from the programmer to the OBD-II connector.
- Select PROGRAM VEHICLE, use the arrow keys to highlight UPLOAD STOCK and press SELECT. Follow the prompts on the screen.
- If the upload fails, you will be asked to AUTO DETECT. Press SELECT and follow the prompts on the screen. If the auto detect fails, please contact Edelbrock Tech Support @ 800-416-8628.
- Once the stock calibration has loaded to the handheld programmer, disconnect the programmer from the OBD-II connector and connect it to your PC using the supplied USB cable.
- Open the SCT software and select the button on the lower left hand side that reads GET STOCK FILE FROM DEVICE. Follow the instructions on the screen. NOTE: The stock calibration file will automatically be labeled using your VIN number followed by ".sul" (XXXXXXXXXXXXX.sul)
- Once the download is complete, you can E-mail your stock vehicle calibration along with the vehicle information below to [calibration@edelbrock.com](mailto:calibration@edelbrock.com) or call 800-416-8628 and our Tech Support staff will assist you with E-mailing the file. NOTE: The subject line of your E-mail should read "Calibration Update".
- Once we have the stock calibration file, along with the requested information below, we can update the calibration to work with your application. We will E-mail you the custom calibration which may be used until the release version of the calibration is available.

**INFORMATION NEEDED:**

E-Mail Address:

Vehicle Year:

Vehicle Make:

Vehicle Model (Specify if Z06, Z51, etc.):

Engine Size:

Transmission:

Fuel Octane (91 or 93 ONLY):

Supercharger System Part Number:

Supercharger Serial Number:

Programmer Serial Number:



## Edelbrock Supercharger 2007-12 GM Trucks; 4.8l, 5.3l 6.0l, 6.2l

### Installation Instructions

## INTRODUCTION

Thank you for purchasing the Edelbrock E-Force Supercharger System for 2007 to 2012 GM Trucks. This supercharger utilizes Eaton's new Gen VI TVS rotors, featuring a four lobe design with a full 160° of twist for maximum flow, minimum temperature rise, quiet operation, and the reliability for which Eaton is known. The Edelbrock Supercharger is a complete system that maximizes efficiency and performance by minimizing air restriction into, and out of, the supercharger. This results in maximum airflow, with minimal temperature rise and power consumption. The supercharger housing itself is integrated into the intake manifold for a seamless design with minimal components, eliminating the possibility of vacuum leaks between gasket surfaces. The system also utilizes a front drive, front inlet configuration giving it the shortest, least restrictive inlet path on the market. The supercharger is inverted, expelling the air upward. Air pressure then builds in the plenum, before being drawn down through each of two intercooler cores, oriented horizontally, next to, and below the supercharger outlet. After passing through the intercooler cores, the air travels through the long 12" runners, which route underneath the supercharger housing to the cylinder head ports, in a horizontal, nested configuration. The upper plenum area is enclosed by a top cover that has been designed to provide an appealing and distinctive under-hood appearance. This configuration allows for a compact package that can fit under the stock hood and cowl of the vehicle, without sacrificing runner length, or intercooler area. The E-Force supercharger features a uniquely styled plenum. The Edelbrock supercharger provides neck snapping performance that is safe to operate on a completely stock engine.

## TOOLS AND SUPPLIES REQUIRED

- Jack and Jack Stands  
OR Service Lift
- Panel Puller
- Ratchet and Socket Set including: 1/4", 7mm, 8mm, 10mm (standard, deep and universal), 11mm, 12mm (deep), 13mm, 15mm, 18mm, 21mm (deep), 24mm
- Wrenches including: 8mm, 10mm, 15mm, 27mm
- 12" Ratchet Extension Bar
- 1/2" Breaker Bar
- Flat Blade & Phillips Screwdrivers
- Compressed Air
- Torx - T20, T25, T30 Driver
- Allen Wrenches including: 5mm, 6mm, 8mm
- 2" Long 5mm Allen Socket
- 3/8" Fuel Line Removal Tool
- Torque Wrench
- Needle Nose Pliers
- Vice Clamp  
OR C-Clamp
- Hose Clamp Removal Tool  
OR Pliers
- Pneumatic  
OR Right Angle Power Drill
- Impact Wrench
- Loctite Threadlocker or equivalent
- Loctite 609 Retaining Compound or equivalent
- Permatex Thread Sealant w/ PTFE, or equivalent
- O-ring Lube
- Anti-seize
- Masking Tape
- Shop Rags
- Zip Ties / Wire Ties
- J-42386-A Flywheel Holding Tool
- 50/50 Coolant Mixture

**Edelbrock LLC, 2700 California Street, Torrance, CA 90503**  
**Toll-Free Tech Line: 1-800-416-8628 Office/Sales Line: 310-781-2222**



**Edelbrock Supercharger  
2007-12 GM Trucks; 4.8l, 5.3l 6.0l, 6.2l**

## **Installation Instructions**

### **IMPORTANT WARNINGS**

**Before beginning installation, use the enclosed checklist to verify that all components are present in the box then inspect each component for damage that may have occurred in transit. If any parts are missing or damaged, contact Edelbrock Technical Support, not your parts distributor.**



**WARNING:** *Installation of this supercharger will result in a significant change to the performance characteristics of your vehicle. It is highly recommended that you take some time to familiarize yourself with the added power, and how it is delivered, in a controlled environment. Take extra care on wet and slippery roads, as the rear tires will be more likely to lose traction, with the added power. It is never recommended to turn off your vehicles traction control system.*

**Please employ proper towing etiquette when towing steep grades. Turn off Air Conditioner and avoid aggressive towing behaviors to avoid any overheating that may occur. DO NOT exceed the manufacturer's maximum tow rating for the vehicle.**

**Proper installation is the responsibility of the installer. Improper installation will void all manufacturer's standard warranties and may result in poor performance and engine or vehicle damage.**

Due to the complexity of the Edelbrock E-Force Supercharging system, it is recommended that this system only be installed by a qualified professional with access to a service lift, pneumatic tools, and a strong familiarity with automotive service procedures. **To qualify for the optional supplemental warranty**, it is necessary to have this system installed by a Certified ASE Technician, GM Dealership, or an Authorized Edelbrock Installer. Failure to do so will void and/or disqualify any and all optional supplemental warranties offered with this system. Please contact the Edelbrock Technical Support department if you have any questions regarding this system and/or how your installer of choice will affect any warranty coverage for which your vehicle may qualify.

**Any previously installed aftermarket tuning equipment must be removed and the vehicle returned to an as stock condition before installing the supercharger.**

Any equipment that directly modifies the fuel mixture or ignition timing of the engine can cause severe engine damage if used in conjunction with the Edelbrock E-Force Supercharger System. This includes, but is not limited to: ignition boxes, air/fuel controllers, OBD-II programmers, and any other device that modifies signals to and/or from the ECU. Aftermarket bolt-on equipment such as underdrive pulleys or air intake kits will also conflict with the operation of the supercharger and must be removed prior to installation. Use of any of these products with the E-Force Supercharger could result in severe engine damage.



**Edelbrock Supercharger**  
**2007-12 GM Trucks; 4.8l, 5.3l 6.0l, 6.2l**

**Installation Instructions**

**IMPORTANT WARNINGS (CONTINUE)**

**NON-Flex Fuel vehicles will require Edelbrock’s Auxiliary Fuel System Upgrade Kit (details below on this page). Please visit our website or call our Tech line at 1-800-416-8628 for more information.**



**91 octane or higher gasoline is required at all times. If your vehicle has been filled with anything less, it must be run until almost dry and refilled with 91 or higher octane gasoline twice prior to installation.**  
**Any failures associated with not using premium 91 octane gasoline or higher, will be ineligible for warranty repairs.**  
**THE FLEX-FUEL FUNCTION HAS BEEN DISABLED. DO NOT USE ANY GASOLINE WITH AN ETHANOL RATING HIGHER THEN 10% (E10). FAILURE TO DO SO WILL RESULT IN ENGINE DAMAGE AND VOID YOUR WARRANTY**

**! WARNING**

**SUPPLEMENTAL FUEL PUMP KIT**

*(Required for 2007-2009 Non-Flex Fuel Vehicles - SOLD SEPARATELY)*

- **DESCRIPTION:** The supplemental fuel kit includes a replacement fuel pump, fuel level sender, injectors and O-rings (*injectors and O-rings available in #15791 ONLY*). This upgrade kit is required for GM Trucks utilizing the #1578 and #1579 E-Force supercharger system (*see kit and model breakdown below*). **Failure to use the supplemental fuel pump kit may result in engine damage and void your Edelbrock E-Force Supercharger’s warranty.** This supplemental fuel pump kit is not needed and will not work on Flex- Fuel models. Flex Fuel models come standard with adequate fuel systems that properly operate the Edelbrock E-Force Supercharger system.

*Supplemental Fuel Pump Part Numbers.*

- P/N - 15781** - '07-'09 4.8L/5.3L Crew/Extended Cab Models Except Long Beds
- P/N - 15782** - '07-'09 4.8L/5.3L Standard Cab Models and All Long Beds
- P/N - 15791** - '07-'09 6.0L/6.2L Crew/Extended Cab Models (Includes Injectors and Injector O-rings)

*Kit includes the following:*

- 1 - Fuel Pump
- 1 - Control Module
- 1 - Fuel Level Sending Unit
- 8 - Injectors (P/N 15791 ONLY)
- 8 - Injectors O-rings (P/N 15791 ONLY)

**Please visit our website or call our Tech line at 1-800-416-8628 for more information.**

**INSTALLATION NOTE:**

*It is critical to install the supplemental fuel pump kit on a vehicle that is able to start once the installation is complete. Once the supplemental fuel pump kit is installed, you must start the vehicle to check for leaks and check engine lights. This installation can be performed prior or after the supercharger installation. If performed after the supercharger installation, DO NOT DRIVE the vehicle without installing the supplemental fuel pump kit first.*



**Installation Instructions**

**INSTALLATION HARDWARE IDENTIFICATION GUIDE**

**Bag #1**



(2x) - M10 x 1.50 x 90mm  
Hex Flange Bolt

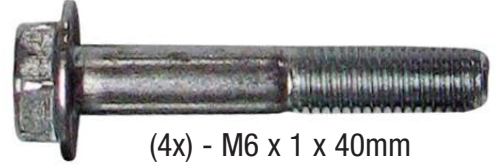

(4x) - M6 x 1 x 40mm  
Hex Flange Bolt



(1x) - M8 x 1.25 x 20mm  
Hex Flange Bolt



(1x) - Rubber Grommet



(1x) - M8 Washer



(2x) - Bushings

**Bag #2**



(6x) - M6 x 1 x 16mm  
Hex Flange Bolt



(2x) - 1/2"  
Hose Clamp



(8x) - 3/4"  
Hose Clamp



(1x) - M8 x 1.25 x 30mm  
Hex Flange Bolt



(2x) - Washer  
5/16 ID



(2x) - M6 x 1 x 35mm  
Hex Flange Bolt



(2x) - M6 x 1 x 25mm  
Hex Flange Bolt



(5x) - M6 x 1 x 10mm  
Hex Flange Bolt



(8x) - Nut  
M6 x 1.0



(2x) - 1" Spacer

**Bag #3**



(11x) - M8 x 1.25 x 25mm  
Countersunk Socket Head Bolt



(8x) - M6 x 1 x 45mm  
Hex Flange Bolt



(4x) - M6 x 1 x 12mm  
Socket Head Bolt



(2x) - M6 x 1 x 16mm  
Button Head Bolt



**Edelbrock Supercharger  
2007-12 GM Trucks; 4.8l, 5.3l 6.0l, 6.2l**

**Installation Instructions**

**Bag #4**

(1x) - GM Factory Harmonic Balancer Bolt



(1x) - M16 x 2 x 120mm Hex Bolt



(1x) - Crank Pinning Drill Guide

(1x) - 1/4" x 3/4" Steel Dowel



(1x) - 15/64" High Speed Steel Drill Bit



(1x) - .2500" Reamer







**HOSE IDENTIFICATION GUIDE**



Recovery Tank to  
Water Pump



Water Pump to LTR



Manifold to Recovery Tank



LTR to Manifold



**Edelbrock Supercharger  
2007-12 GM Trucks; 4.8l, 5.3l 6.0l, 6.2l**

**Installation Instructions**

---

Driver side PCV  
Valve Cover to Manifold Nose



Passenger Side PCV  
Valve Cover to Intake



EVAP to Manifold



Brake Booster Hose





# Edelbrock Supercharger 2007-12 GM Trucks; 4.8l, 5.3l 6.0l, 6.2l

## Installation Instructions

### WIRE HARNESS GUIDE

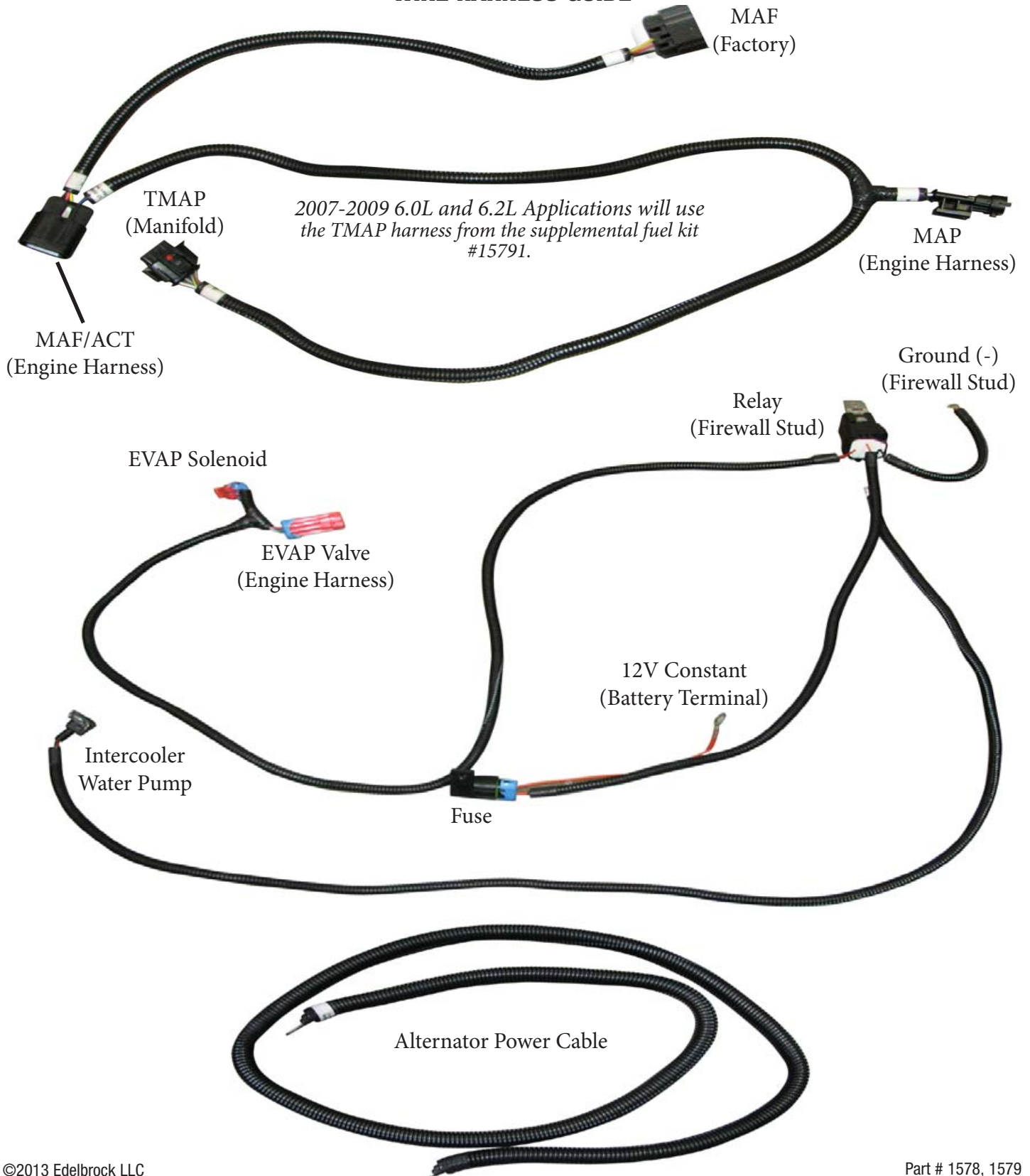



## Edelbrock Supercharger 2007-12 GM Trucks; 4.8l, 5.3l 6.0l, 6.2l

### Installation Instructions

#### SUPERCHARGER INSTALLATION

**WARNING: Battery must be sufficiently charged before starting the PCM flashing procedure.**

**Only begin the PCM flashing procedure when you have downloaded the calibration file from the Edelbrock Calibration Team to the handheld programmer. Do not flash the PCM until you are ready to install the supercharger. Once the PCM is flashed, DO NOT START the engine until the installation of the E-Force supercharger is complete.**

1. Put the car into ACC mode, but don't start the vehicle.
2. Connect the supplied PCM cable on the handheld programmer to the OBD-II connector located below the steering wheel, and to the left of your knee.
3. Use the directional pad to highlight the Program Vehicle option and press the Select button.

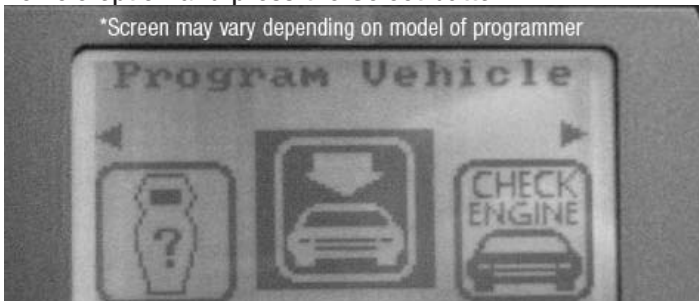

4. Use the directional pad to highlight the Pre-programmed Tune option and press the Select button.
5. Read the disclaimer then press Select to continue.
6. Verify that the ignition is in the 'Key On' position and that the engine is not running, then press Select.
7. Use the directional pad to highlight your vehicle and transmission combination then press Select.
8. Use the directional pad to highlight the Begin Program option then press Select.

9. Depending on your specific drivetrain configuration, several separate operations may take place during this step. Completion of each operation will cause the progress bar to reset to zero.

10. DO NOT unplug the programmer until prompted.

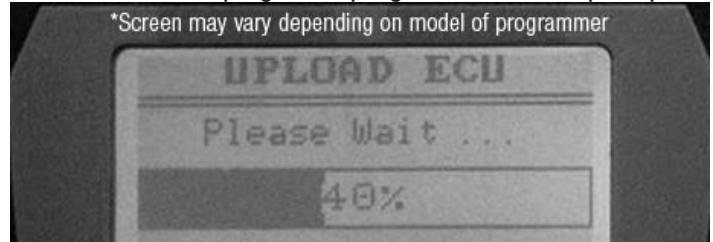

11. Turn the vehicle off when prompted to do so by the handheld programmer.
12. Read the parting message from programmer then press Select to continue.
13. Unplug the programmer cable from the OBD-II port. This concludes the PCM flashing procedure. DO NOT start the engine until the supercharger installation is complete.
14. Using a 10mm socket, remove the negative battery cable.

15. Using a flat blade screwdriver, pry up the heads of the eight (8) push-pins, then use a panel puller to fully remove the push pins. Lift the radiator shroud off the vehicle and set aside along with the push-pins.

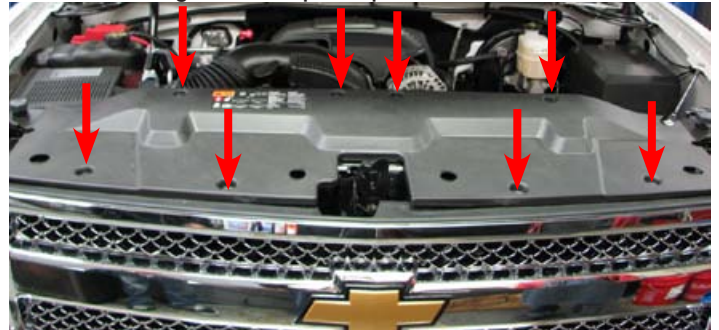

16. Using a 10mm socket, remove the four (4) bolts securing the grill. Now use pliers to detach the six (6) clips behind the grill to fully remove.





## Edelbrock Supercharger 2007-12 GM Trucks; 4.8l, 5.3l 6.0l, 6.2l

### Installation Instructions

17. Remove the engine cover by lifting the front of the cover up to detach the clips, then lift the rear of the cover to fully remove.

18. Remove the passenger side PCV tube by un-clipping it from the passenger side valve cover. Now remove the air intake tube by loosening the two (2) worm clamps and pulling the tube off the throttle body and the airbox.



19. Using a 15mm socket and a breaker bar, remove the serpentine belt by rotating the tensioner clockwise until the belt can slide off the idler pulley.

20. Unplug the alternator connector and remove the power cable using a 10mm socket. Now remove the two (2) bolts, using a 15mm socket to fully remove the alternator.

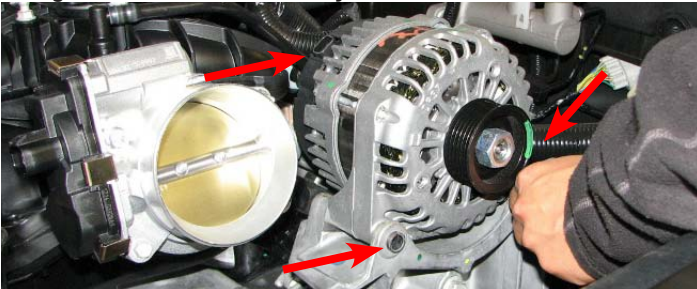

21. Remove the idler pulley on the alternator bracket using a 15mm socket. **NOTE:** Hardware from this idler pulley (bolt, washer and bushing) will be reused later.



22. Remove the top engine harness retainer bracket by removing the three (3) bolts using a 10mm socket. Then unravel the retainer bracket from the engine harness to remove the retainer bracket completely (if equipped).



23. Disconnect and remove the driver side PCV tube located on top of the manifold and driver side valve cover.



24. Disconnect the EVAP solenoid hoses and unplug the EVAP harness. Then unplug the MAP harness from the MAP sensor and ETC harness from the throttle body.

**CAUTION:** Use care when removing the clip on the ETC plug, as they break easily.

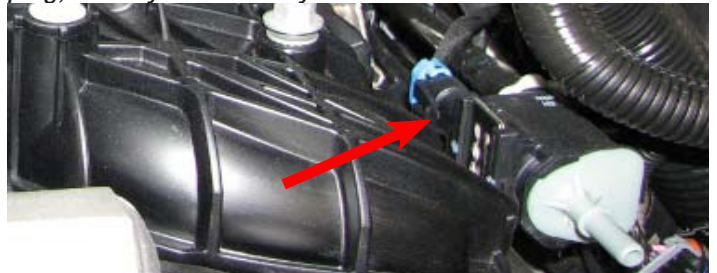

25. Remove the brake booster hose from the check valve. **NOTE:** Retain the check valve for re-use.





## Edelbrock Supercharger 2007-12 GM Trucks; 4.8l, 5.3l 6.0l, 6.2l

### Installation Instructions

26. Using a 10mm socket, remove the bracket securing heater the hoses.



27. Disconnect all eight (8) injector plugs (four driver side, four passenger side).

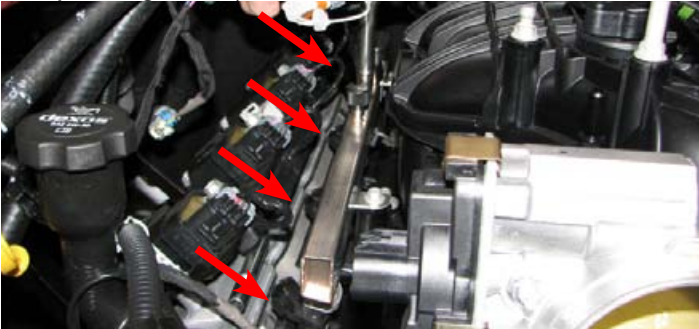

28. Remove the plastic cap on the schrader valve located on the passenger side fuel rail. Place a towel over the schrader valve and carefully release the pressure from the fuel system using a small flat head screwdriver or equivalent.



29. Remove the fuel hose safety clip, then remove the fuel supply line using a 3/8" Fuel Line Removal Tool.



30. Unhook the main engine harness from the rubber hooks on the intake manifold and move the harness behind the manifold.

31. Remove the manifold by loosening the ten (10) bolts with an 8mm socket.

32. Use a clean shop rag to wipe down the intake flange of both cylinder heads. Apply masking tape to the head ports to prevent any dirt or debris from entering the ports.

33. Unplug the coil pack main harnesses and the coil boots. Then remove the driver & passenger side coil bracket assemblies by removing five (5) bolts (on each side) using a deep 10mm socket.

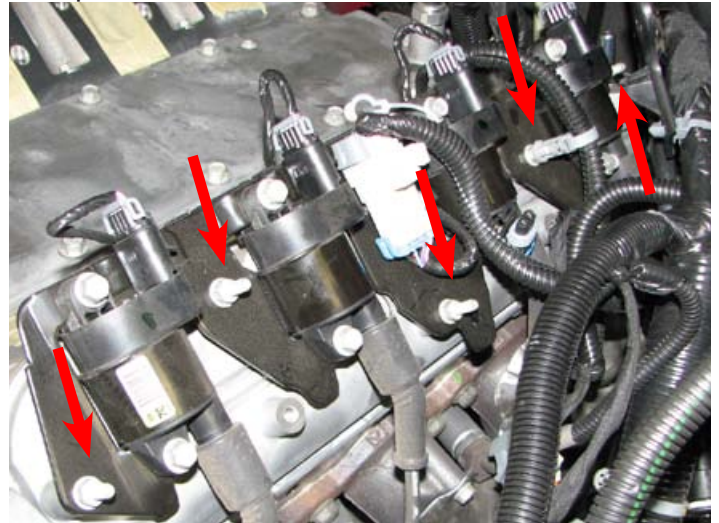

34. Using a small flat head screwdriver or equivalent, remove the plastic covers from the coil brackets (these will not be re-used).

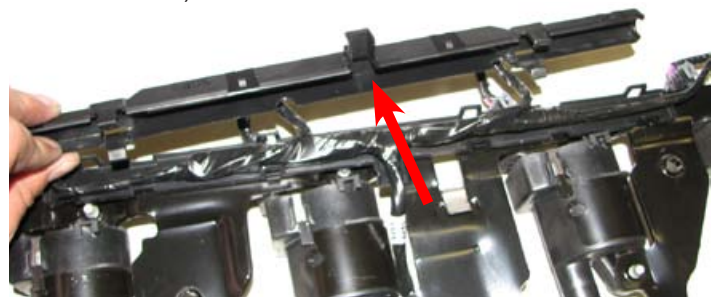



## Edelbrock Supercharger 2007-12 GM Trucks; 4.8l, 5.3l 6.0l, 6.2l

### Installation Instructions

35. Remove the factory valley tray, by unplugging the oil pressure sensor and the Active Fuel Management (AFM) system (if applicable). Use a 27mm wrench to remove the oil pressure sensor from the valley tray. Unbolt the eleven (11) bolts securing the valley tray using a 13mm socket.



**NOTE:** Steps 36-44 outline the procedure for disabling the Active Fuel Management (AFM) system. If your vehicle is not equipped with the AFM system, proceed to Step 45.

**There are two (2) variants of the AFM valley trays:**

- Use Steps 36-40 if your solenoid assembly is secured to the valley tray with Torx bolts.
- Use Steps 41-44 if your solenoid assembly is secured to the valley tray with rivets.

**TIP:** Valley trays with AFM systems will have solenoids attached to the backside of the valley tray as pictured below. Valley trays without AFM systems will not.

36. Use a T-20 Torx driver to remove the four (4) bolts retaining the plastic solenoid bracket, then pry open the clip at the rear of the plate to remove the bracket.

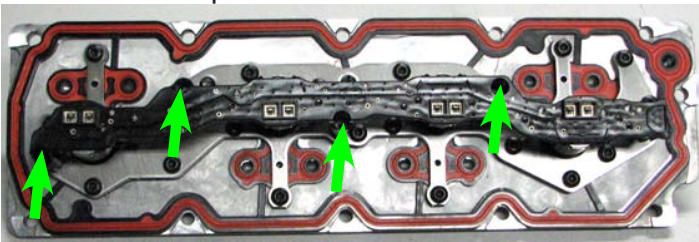

37. Rotate each solenoid 90° clockwise and remove.

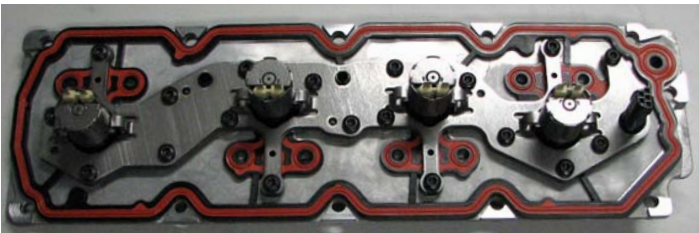

38. Use a T-30 Torx driver to remove the twenty (20) bolts holding the solenoid base plate in place and remove.

39. Carefully remove the plastic and rubber gasket from the valley tray. Do not discard or damage the seal as it will be reused.

40. Trim the two (2) bosses projecting from the gasket to the base of their tapers to allow the valley tray to sit flush when installed (verify proper clearance before installing). Use a file to remove any burrs, then install the gasket onto the new valley tray. Proceed to Step 50.

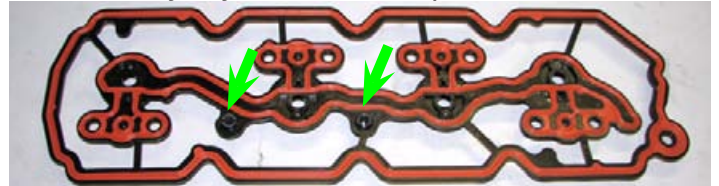

**NOTE:** Steps 41-44 only applies to vehicles with solenoid assemblies which are secured to the valley tray with rivets. Disregard otherwise.

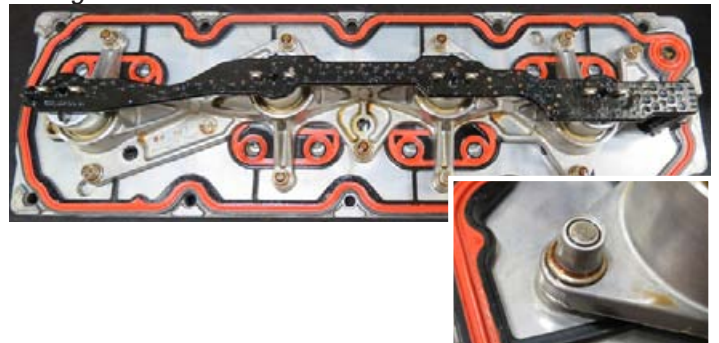

41. Using a cutoff wheel or equivalent, cutoff eleven (11) rivets securing the solenoid assembly onto the valley tray. Be careful not to damage the gasket as it will be reused.





## Edelbrock Supercharger 2007-12 GM Trucks; 4.8l, 5.3l 6.0l, 6.2l

### Installation Instructions

42. Remove the solenoid assembly from the valley tray and carefully remove the gasket.



43. Using a precision grinding tool, grind down six (6) bosses on the gasket until they are flush with the gasket. Be careful not to damage the perimeter seals of the gasket.

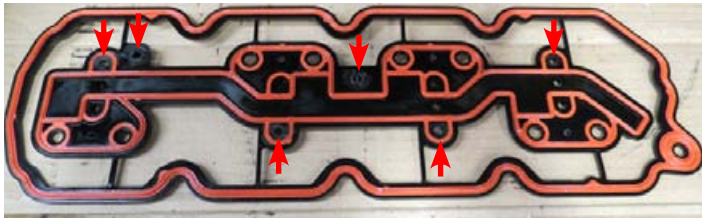

44. Using a 5/32" drill bit, drill out four (4) bleed holes in between the lifter bosses as shown. Place the gasket onto the supplied valley tray to verify that the drilled holes are aligned with the grooves on the valley tray. Clean the gasket to remove any debris and install onto the supplied valley tray. Proceed to Step 50.

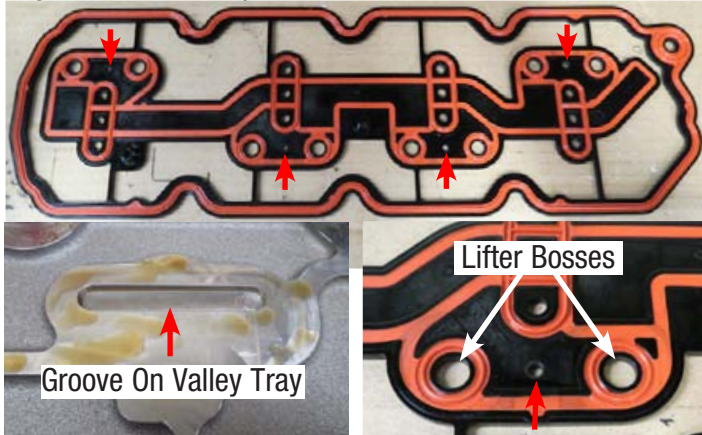

**NOTE:** Steps 45-49 are for Non-AFM vehicles only. If using #1578 please use Steps 45-47. If using #1579 please use Steps 48-49. Disregard if your vehicle is equipped with an AFM system.

45. Place shop rags inside the opening of valley tray to prevent foreign objects from falling into the engine block openings.

46. Using a little clean engine oil, install eight (8) provided O-rings onto the eight (8) top caps if not already done so.

47. With clean, oil free hands, carefully install the top caps in the eight (8) locations shown below. Be careful not to drop the top caps as they may enter the engine block. Now install the provided valley tray gasket and remove the shop rag. Proceed to Step 50.

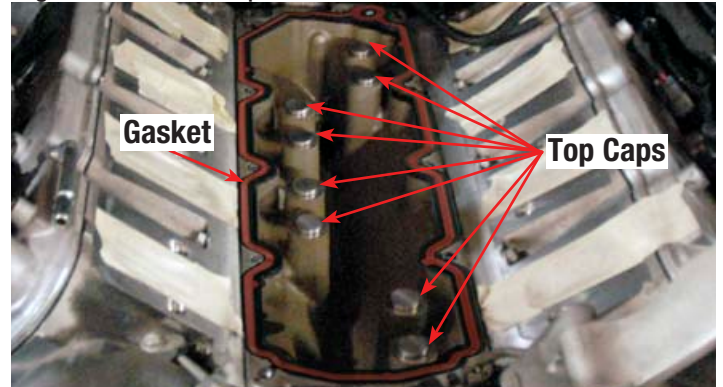

48. Use a small flathead screwdriver to remove the eight O-ring seals from the stock valley plate and install them on the supplied valley plate.



49. Using the stock perimeter gasket, install the valley tray onto the engine block. Proceed to Step 50.





## Edelbrock Supercharger 2007-12 GM Trucks; 4.8l, 5.3l 6.0l, 6.2l

### Installation Instructions

50. Using a 5mm Hex tool, install the valley tray using eleven (11) supplied M8 x 25mm countersunk bolts in Bag #3. Apply anti-seize to the taper undersides of the bolt heads and tighten in a criss cross pattern starting from the inside and working outwards. Torque bolts to 18 ft/lbs (25 Nm).



51. Apply Permatex Thread Sealant w/ PTFE, or equivalent, to the threads on the oil pressure sensor and reinstall. Torque to 26 ft/lbs (35 Nm).

**NOTE: DO NOT use Teflon tape as it will not seal properly.**

52. Raise the front of the vehicle using a service lift or equivalent. Remove four (4) bolts securing the skid plate using a 15mm socket (if equipped).

53. Unbolt the starter by removing two (2) bolts with a 13mm socket. Now remove the flywheel cover using a 10mm socket. Move the starter aside as it is difficult and unnecessary to remove completely.

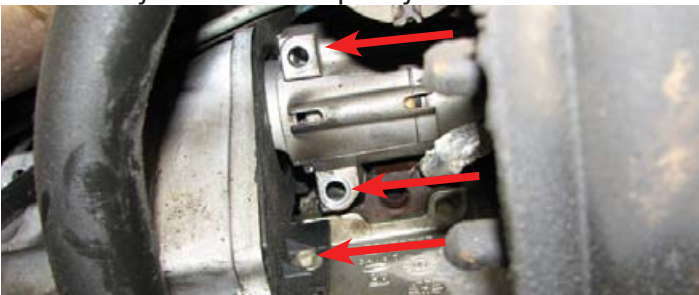

54. Install GM Flywheel Holding Tool #J-42386-A or equivalent, to prevent the crank from rotating while loosening the balancer bolt. Torque the bolts to 37 ft/lbs (51 Nm).

55. Remove the balancer bolt, using a breaker bar and a 24mm socket.

*TIP: A long pipe slid over the breaker bar can be helpful for increasing leverage.*

56. Loosely install the supplied hex bolt and reamer guide to the end of the crank. Rotate the reamer guide until the drilling bushing is at a comfortable position for drilling. Securely tighten the reamer guide and bolt using a 24mm socket.



57. Mark the supplied drill bit with a piece of masking tape. It must measure 1.6" from the tip.

58. Lubricate the drill bit with a small amount of engine oil. Then locate the guide hole with the drilling bushing. Begin drilling using a Right Angle Drill (or equivalent) and the supplied 15/64" drill bit. The drilling process is complete when the tape mark on the bit meets the guide.

59. Loosen the balancer bolt and remove any metal debris with compressed air. Rotate the guide until the ream hole lines up with new dowel pin hole on the crank. Use the supplied .2500" ream tool to verify that the holes are aligned. Then tighten the bolt and ream the hole.

60. Remove the balancer bolt and reamer guide. Clear out any remaining metal debris with compressed air. Apply red Loctite retaining compound or equivalent, to the supplied dowel pin and gently tap it into the new dowel pin hole until it is flush.

61. Apply red Loctite to the threads of the supplied balancer bolt and install it onto the crank. Torque it to 37 ft-lbs (51 Nm), then rotate it an additional 140° using a breaker bar.

62. Remove the GM Flywheel Holding Tool and reinstall the flywheel cover and starter using the factory bolts. Torque starter bolts to 37 ft-lbs (51 Nm).



## Edelbrock Supercharger 2007-12 GM Trucks; 4.8L, 5.3L 6.0L, 6.2L

### Installation Instructions

63. Remove two (2) bolts off the passenger side bumper support using a 15mm socket. **NOTE:** Location is just inside of the passenger wheel well liner, underneath the body mount.

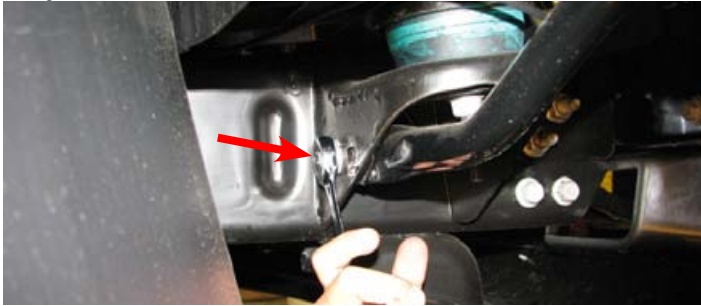

64. Assemble the supplied water pump to the water pump bracket and bracket strap. Clock the water pump so that the outlet port (side port) is pointing towards the passenger side of the vehicle. Securely fasten the strap to the bracket with the supplied M8 x 30mm bolt in Bag #2. Now install the water pump assembly to the passenger side bumper support brace using the factory bolts.

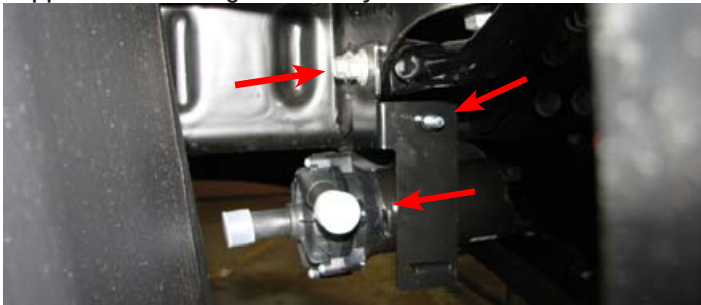

65. Drain the coolant (as needed) by removing the petcock from the radiator. Coolant level must be below cylinder head coolant bleed pipes/crossover to prevent coolant overflow in the next step. Reinstall the petcock.

66. Using pliers, remove coolant feed hose from coolant cross over. Now remove coolant crossover using a 10mm socket.

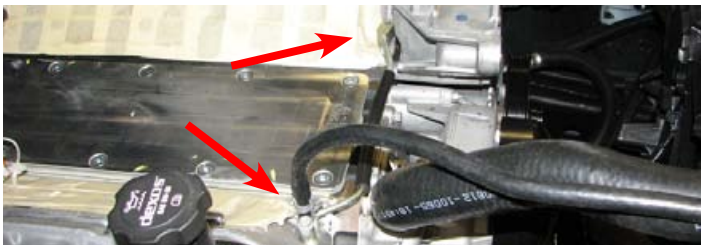

67. Using a razor blade or equivalent, remove the rubber guard on the factory coolant crossover and install it onto the supplied coolant crossover.



68. Using a 10mm socket, install the supplied coolant cross-over using the factory bolts, making sure the inlet port is on the driver side.



69. Remove the rear engine support brace attached to the rear of the driver side cylinder head using a 15mm socket.



70. Two (2) of the stock intake manifold bolt holes in the cylinder heads break into the crankcase and are not used with this supercharger. Remove the tape covering the intake ports. Install two (2) button head bolts supplied in Bag #3 in the front passenger side and rear driver side intake manifold bolt holes.



## Edelbrock Supercharger 2007-12 GM Trucks; 4.8L, 5.3L 6.0L, 6.2L

### Installation Instructions

**NOTE:** Steps 71-72 are for vehicles equipped with 4.8L/5.3L engines. Vehicles equipped with 6.0L / 6.2L engines, proceed to Step 73.

71. Remove the gaskets on the factory intake manifold if not already done so. Using side cutters or equivalent, trim down the three (3) retention clips and the center locating tab. Use CAUTION while trimming the clips. Re-inspect the gaskets after modification for any tears and replace as necessary. Install onto the manifold to verify a flush fit.

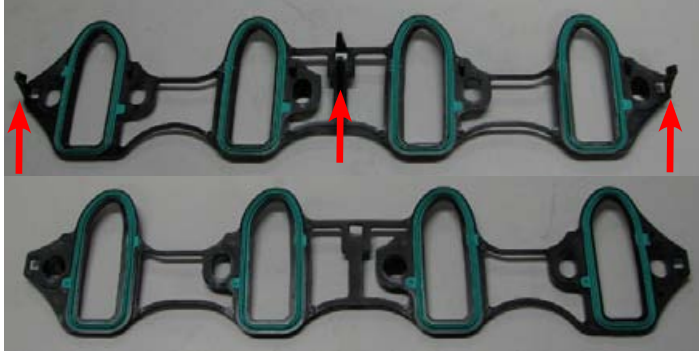

72. Install the modified intake manifold gaskets onto the supercharger manifold using the installed bushings as guides. Proceed to Step 75.

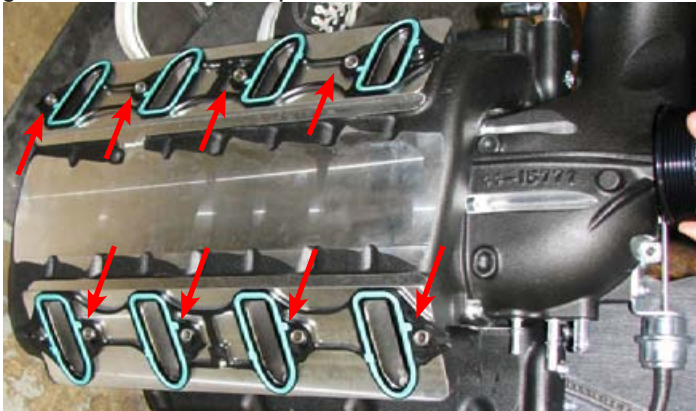

**NOTE:** Step 73 only applies to vehicles with 6.0L / 6.2L engines. Proceed to Step 75 if your vehicle is equipped with a 4.8L or 5.3L engine.

73. Install the eight (8) supplied manifold O-ring gaskets to the manifold ports as shown below.

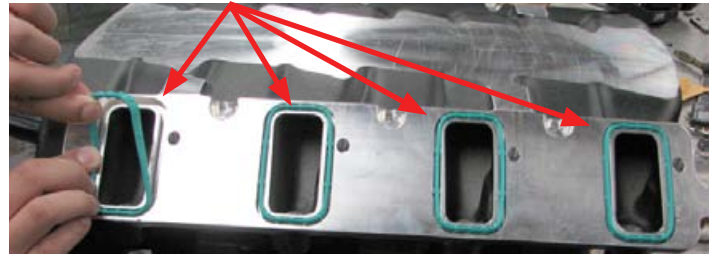

74. Connect the supplied TMAP harness to the MAP sensor on the back of the supercharger. Bundle the harness up and wrap over the top of the manifold to avoid damage during installation of the supercharger.

**NOTE:** 2007-09 6.0/6.2L Applications will use the TMAP harness from the supplemental fuel kit #15791.



75. Gently spray silicone lubricant or equivalent, onto the cylinder heads to help align the supercharger manifold.

**NOTE:** Supercharger manifold is very heavy. The following step should be performed with more than one person, an engine hoist, or equivalent.

Be careful not to pinch the TMAP harness or break the manifold gaskets, as broken gasket debris can fall into the cylinder head ports.

76. Carefully lower the manifold onto the engine so that the bushings set properly (Only applies to 4.8L and 5.3L).

**NOTE:** Check to make sure there are no gaps between the gaskets and the manifold as well as the gaskets and the cylinder heads. On 6.0L and 6.2L, the manifold should sit flush with the cylinder heads.



## Edelbrock Supercharger 2007-12 GM Trucks; 4.8l, 5.3l 6.0l, 6.2l

### Installation Instructions

77. Secure the manifold using eight (8) supplied M6 x 45mm bolts in Bag #3. Using a 10mm socket with universal joint, tighten the bolts according to the torque sequence diagram below. Torque the bolts to 44 in/lb (5 Nm). Then re-torque in the same sequence to 89 in/lb (10 Nm).

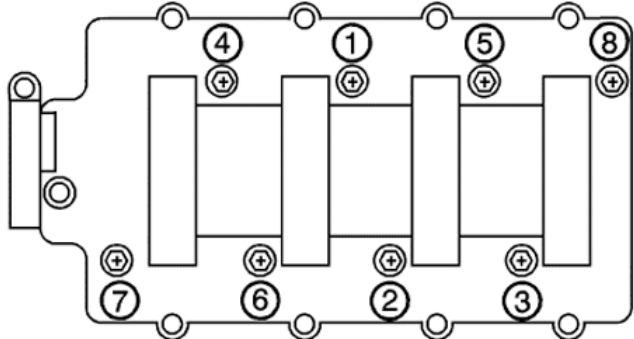

78. Remove the factory installed O-rings from the supplied injectors on the outlet port. Lightly apply O-ring lube to the supplied larger O-rings and install them onto the injectors.

**2007-2012 4.8L/5.3L** - Use provided injectors and larger O-rings in this kit.

**2007-09 6.0L/2007-08 6.2L** - Use injectors and larger O-rings from fuel pump kit #15791 (Required - Not included).

**2009-2011 6.2L** - Re-use stock injectors w/ supplied larger O-rings.

*NOTE: The larger O-rings must be used to avoid vacuum leaks. 2009-2011 6.2L vehicles will need to remove the injectors from the factory manifold if not already done so.*



79. Remove and discard the factory installed metal clips on the injectors.



80. Lightly lubricate the O-rings on the fuel rail fittings. On the passenger side rail, install one (1) straight fitting on the provision nearest to the bolt hole and the black plug on the opposite end as shown. On the driver side rail, install the 90° black anodized fitting onto the provision nearest to the bolt hole and the straight fitting on the opposite end as shown. Lubricate the all O-rings on the injectors and install them into the fuel rail so that the electrical connectors face away from the supercharger.

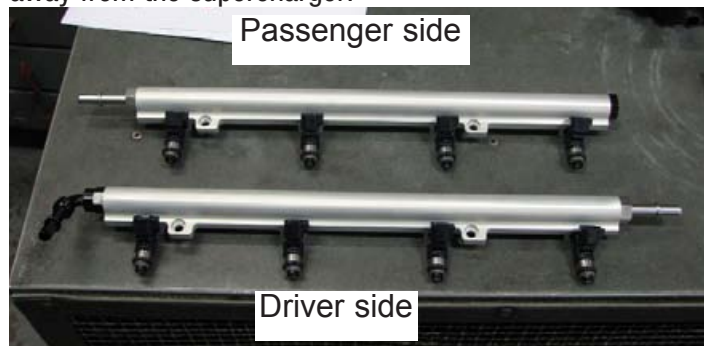

81. Lower the fuel rail assembly onto the manifold and line up the injectors with their provisions on the manifold. Gently, push down on the rails until the injectors are fully seated. Using a 5mm Hex tool, install the four (4) M6 x 12mm bolts supplied in Bag #3 to secure the fuel rails to the manifold.



## Edelbrock Supercharger 2007-12 GM Trucks; 4.8l, 5.3l 6.0l, 6.2l

### Installation Instructions

82. Install the supplied fuel cross-over hose onto the passenger side zinc 3/8" adapter and route it behind the manifold over towards the driver side fuel rail. Make sure the cross-over hose routes behind the main fuel supply line and connect it to the zinc 3/8" adapter on the driver side fuel rail.



83. Install the supplied fuel supply line extension by inserting the male end into the main fuel supply line. Then connect the extension to the 90° black anodized fitting on the driver side fuel rail.



84. Unravel the rear injector plug and EVAP plug approximately 2-3". Also unravel the alternator harness from the main harness about 2-3". Re-secure harness with electrical tape.

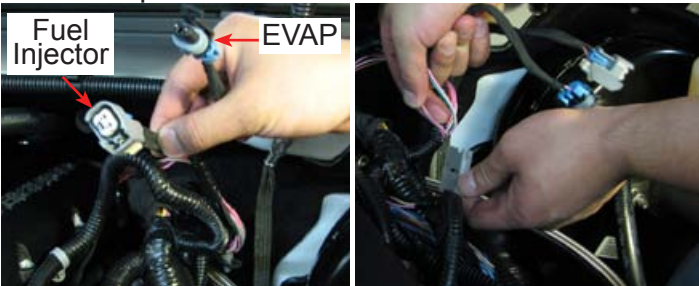

85. Re-connect all eight (8) fuel injector plugs. Reinstall the coil pack assemblies using a 10mm socket and the factory bolts. Then plug in the main coil pack harnesses and the coil pack boots.

86. Using a 10mm socket, remove four (4) lower bolts on the front A-frame brace located behind the radiator shroud. **NOTE:** The Power Steering cooler can be unbolted and moved to clear the driver side bolts on the A-frame. Remove two (2) additional bolts towards the top of the A-frame brace located behind the assembly.

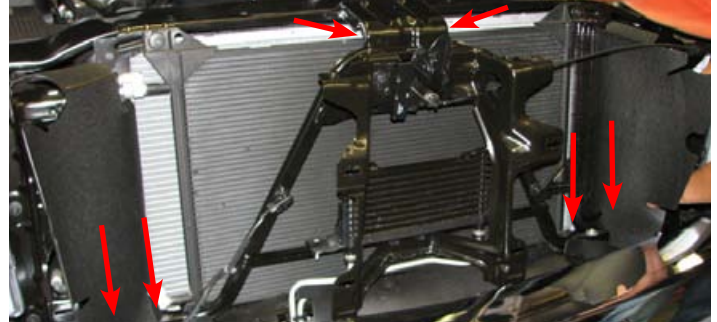

87. Using a 10mm socket, remove two (2) center bolts and two (2) side bolts securing Aux cooler.

**NOTE:** Earlier models are equipped with two (2) additional center bolts located above the Aux cooler and side plastic push pins rather than bolts.

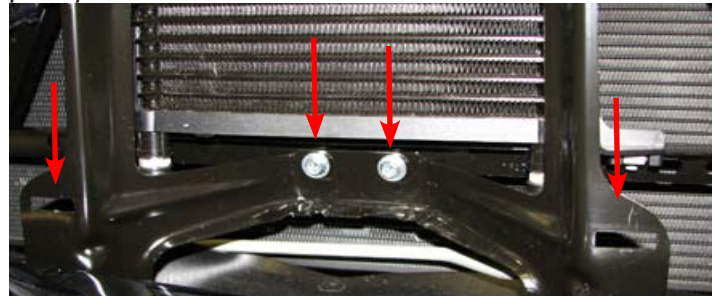

88. Gently pull the front A-frame brace assembly forward and carefully slide in the Low Temp Radiator (LTR) through the passenger side.

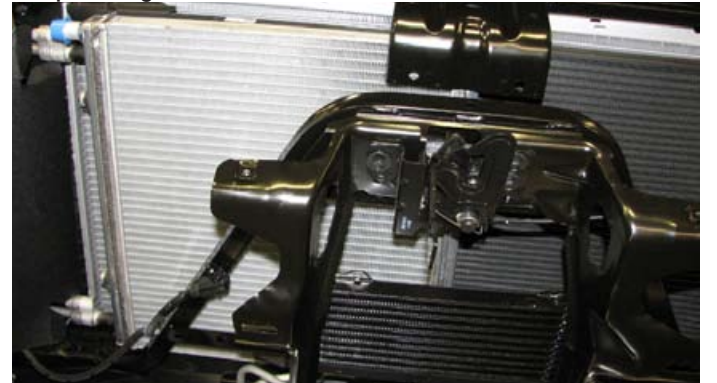



## Edelbrock Supercharger 2007-12 GM Trucks; 4.8l, 5.3l 6.0l, 6.2l

### Installation Instructions

89. Gently pull the Aux cooler and the hard lines forward and lower the LTR pass the Aux cooler hard lines. Then reinstall the two (2) top bolts on the front A-frame brace using a 10mm wrench.

**NOTE:** LTR must be temporarily lowered past the Aux cooler hard lines to reinstall the two (2) upper bolts.



**NOTE:** Step 90-92 only applies to vehicles with Aux coolers which use side mounting bolts. Skip to Step 93 if the sides of your Aux cooler is secured using push pins.

90. Insert two (2) supplied 5/16" washers from Bag #2 into the side bolt locations of the Aux cooler.

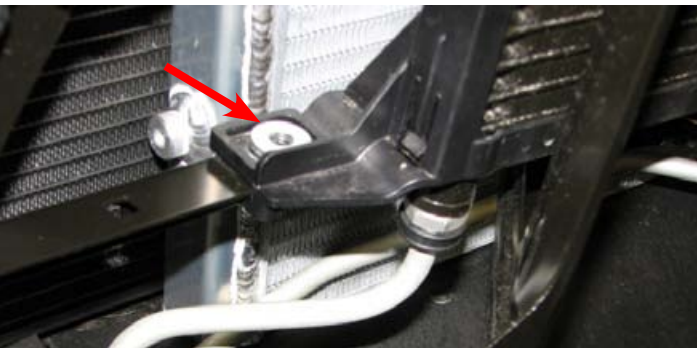

91. Loosely install the upper LTR bracket to the upper bung on the LTR with one (1) supplied M6 x 10mm bolt in Bag #2. Secure the upper driver side LTR bracket using a supplied M6 x 16mm bolt and a M6 nut from Bag #2 to the A-Frame.

**NOTE:** Some vehicles will have a harness attached to the upper A-frame mounting location. Remove the harness from this location and secure it to the hood release cable with a wire tie.

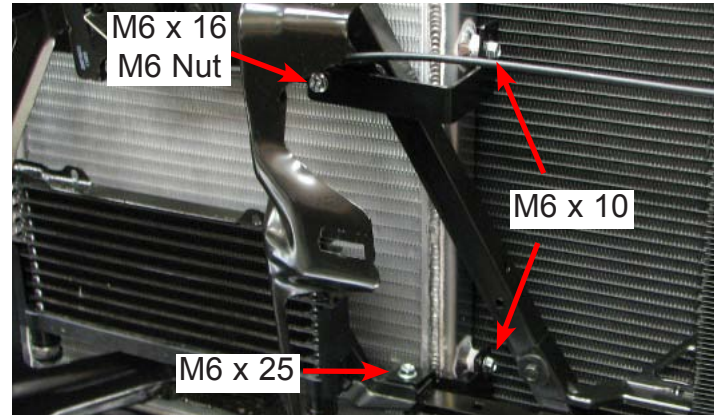

92. Using a 10mm socket and the supplied M6 x 10mm bolt in Bag #2, loosely install the lower passenger LTR bracket to the lower bung on the LTR so that the slot is mounted on the LTR bung. Now install the supplied M6 x 25mm bolt from Bag #2 to the side mounting location of the Aux cooler. Repeat for the lower driver side bracket. Re-align the LTR to ensure adequate clearance with other components, then securely tighten the bolts. Proceed to Step 95.

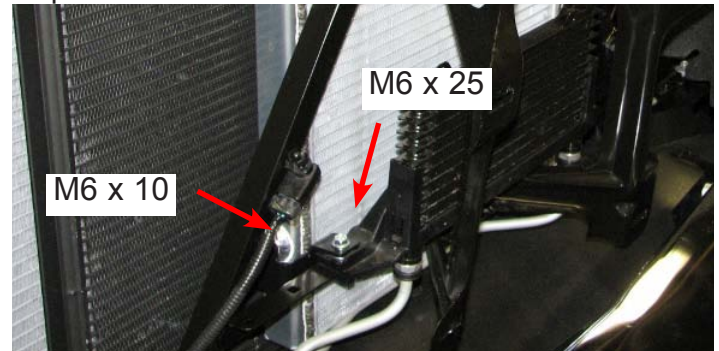



## Edelbrock Supercharger 2007-12 GM Trucks; 4.8l, 5.3l 6.0l, 6.2l

### Installation Instructions

**NOTE:** Step 93-94 only applies to vehicles with Aux coolers which use side mount push pins. Disregard otherwise.

93. Loosely install the lower LTR brackets to the side mounting location of the Aux cooler using the 1" spacers, two (2) 35mm bolts, and two (2) M6 nuts from Bag #2. Loosely secure both brackets to the lower bungs on the LTR using two (2) M6 x 10mm bolts from Bag #2.

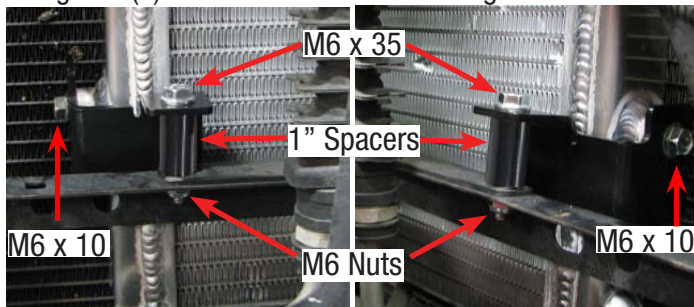

94. Loosely install the upper LTR bracket to the upper driver side bung on the LTR with one (1) supplied M6 x 10mm bolt in Bag #2. Secure the LTR bracket to the A-Frame using a supplied M6 x 16mm bolt and a M6 nut from Bag #2. Re-align the LTR to ensure adequate clearance with other components, then securely tighten all bolts and nuts.

**NOTE:** Some vehicles will have a harness attached to the upper A-frame mounting location. Remove the harness from this location and secure it to the hood release cable with a wire tie.

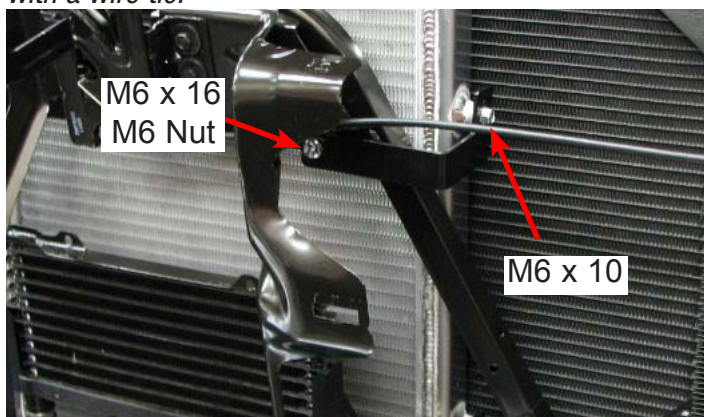

95. Using two (2) M6 x 10mm bolts, secure the Aux cooler to the A-frame. Reinstall the two (2) top center bolts (if applicable).

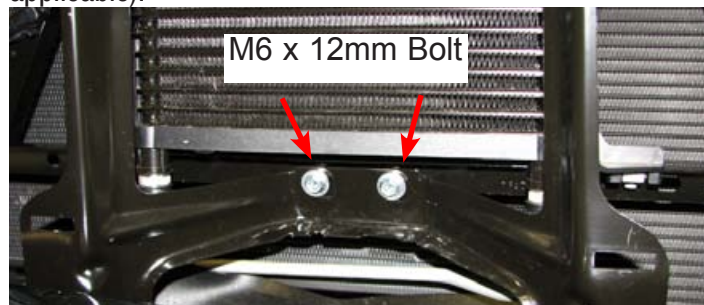

96. Route the water pump to LTR hose behind the radiator shroud and down towards the water pump. Install the hose on to the water pump outlet barb with the supplied 3/4" hose clamps from Bag #2.

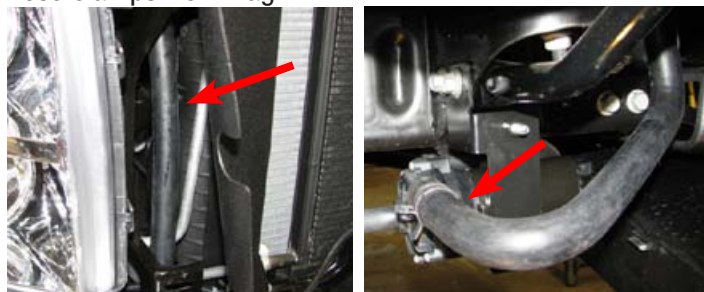

97. Using a hose clamp tool or equivalent, install the water pump to LTR hose to the LTR inlet barb with the supplied 3/4" hose clamps from Bag #2.

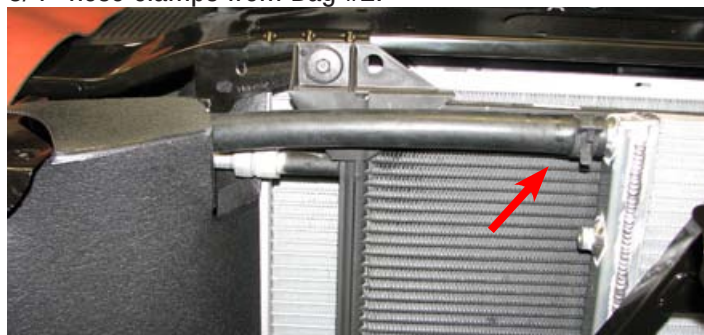



## Edelbrock Supercharger 2007-12 GM Trucks; 4.8l, 5.3l 6.0l, 6.2l

### Installation Instructions

98. Route the LTR to Manifold Hose along the bottom of the radiator fan shroud and install onto the passenger side manifold inlet barb.



99. Install the other end of the LTR to Manifold hose onto the driver side manifold inlet barb.

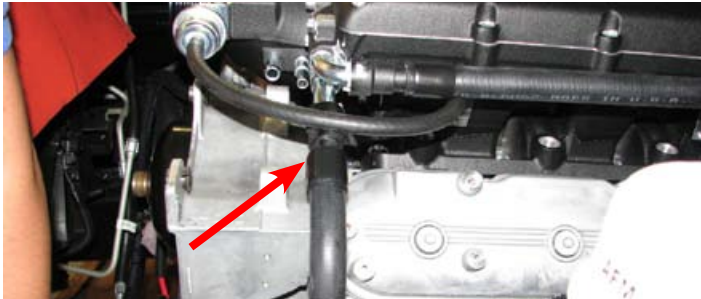

100. Now route the LTR to Manifold hose towards the LTR as shown below, and secure it to the LTR outlet barb using the supplied 3/4" hose clamps in Bag #2.



101. Use wire ties to secure the LTR to Manifold Hose to the lower radiator fan shroud as shown.

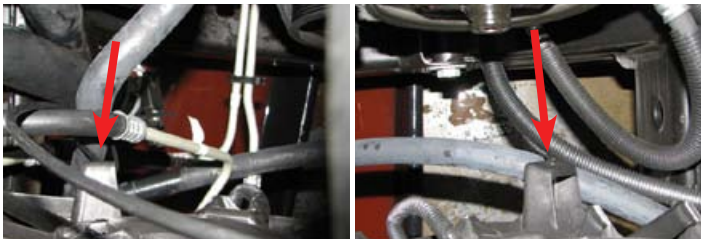

102. Install the Manifold to Recovery Tank hose onto the passenger side outlet barb on the manifold.



103. Then route the hose behind the manifold and install it onto the driver side manifold outlet barb.



104. Using the supplied M6 x 16mm bolts in Bag #2, install the recovery tank brackets onto the recovery tank as shown.







## Edelbrock Supercharger 2007-12 GM Trucks; 4.8l, 5.3l 6.0l, 6.2l

### Installation Instructions

105. Connect the Manifold to Recovery Tank hose to the recovery tank inlet barb using a 3/4" clamp. Connect the Tank to Water Pump hose to the tank's outlet barb, secure with 3/4" clamp. Route Tank to Water Pump hose towards water pump and install onto inlet barb using 3/4" clamp. Then install the tank onto the two (2) front passenger side coil pack studs with M6 nuts in Bag #2.



106. Using a small flat head screwdriver, remove the factory EVAP solenoid off the factory fuel rail assembly.



107. Install the supplied EVAP bracket onto the driver side coil pack assembly stud using one (1) M6 nut from Bag #2. Stud location is in between the first and second coil packs. Install the factory EVAP on to the EVAP bracket as shown.



108. Install the factory EVAP hose to the rear barb of the EVAP solenoid. Now install the provided EVAP hose on the right rearmost barb of the manifold nose and connect it to the front barb of the solenoid. DO NOT connect the EVAP harness to the solenoid.

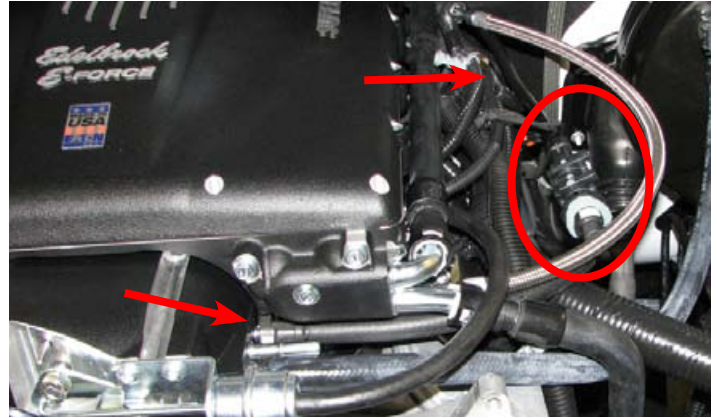

109. Clock the brake booster check valve approximately 90° counter clockwise. Using the 1/2" hose clamps from Bag #2, install the provided brake booster vacuum hose to the brake booster check valve and to the first barb on the manifold nose. Reinstall the brake booster check valve harness (if applicable).





## Edelbrock Supercharger 2007-12 GM Trucks; 4.8l, 5.3l 6.0l, 6.2l

### Installation Instructions

110. Install the driver side PCV hose by sliding it onto the rear barb located on the driver side valve cover. Then install it on the center barb located on the manifold nose. Be sure to route the hose between the coil bracket and intercooler hose.

**NOTE:** On earlier vehicles, the rear barb on the driver side valve cover will be outfitted with a non-quick connect barb. If this applies to your vehicle, you must remove the quick connect fitting on the supplied hose and use the supplied hose clamp to secure the PCV hose to the valve cover barb.



111. Using a vice clamp or equivalent, install the bushings onto the supplied alternator bracket as shown.

**NOTE:** Use CAUTION when applying pressure to the bushings to avoid bending the bushing tabs.

**TIP:** You can use a shallow 14mm socket to protect the surface of the bracket while clamping the alternator bracket.

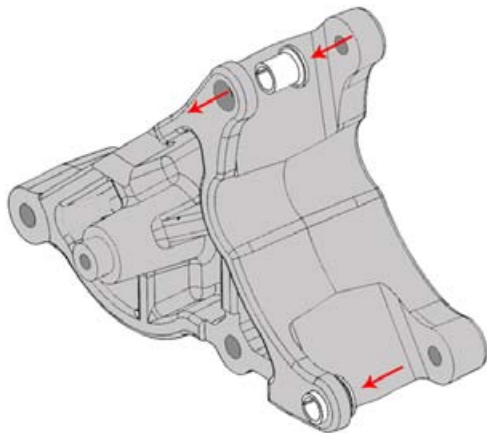

112. Install the supplied rubber grommet into the hole located in the upper cavity of the alternator bracket. Using a 15mm socket, install the alternator bracket with the factory alternator bolts. Route the actuator hose through the grommet as shown, and re-connect to the actuator.



113. Remove the bolt, washer and bushing from the stock 90mm pulley and install them on the supplied 76mm pulley.



114. Apply Loctite to the threads on both idler pulley bolts. Then use a 15mm socket to install the 76mm idler pulley with the factory hardware to the left idler pulley location. Install the additional idler pulley to the right idler pulley location with the M8 x 20mm bolt and M8 washer from Bag #1. Verify that both pulleys spin freely.

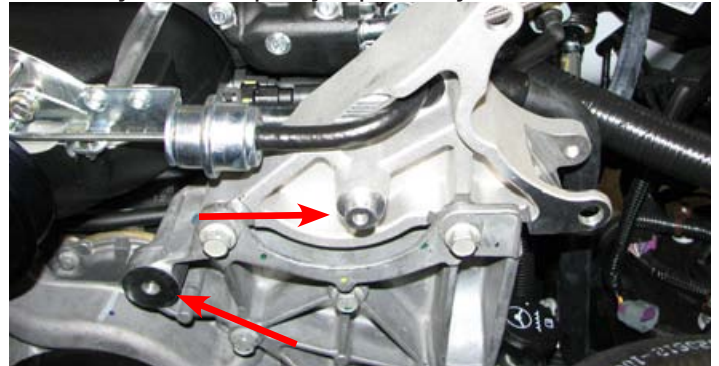



## Edelbrock Supercharger 2007-12 GM Trucks; 4.8l, 5.3l 6.0l, 6.2l

### Installation Instructions

115. Using a small flat head screwdriver, remove the black ABS backing by releasing the three (3) locking tabs. Then remove the four (4) bolts securing the alternator housing using a 1/4" socket.

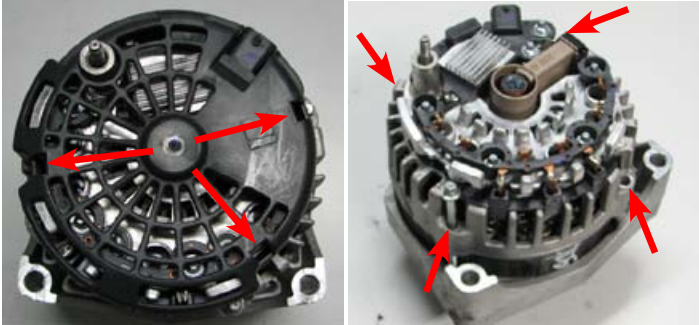

116. Clock the rear portion of the alternator clockwise one bolt position so that the harness plug points at the right mounting hole. Apply Loctite to the bolt threads and reinstall the four (4) alternator bolts and plastic cover.



117. Using a 15mm socket and the supplied M10 x 90mm bolts in Bag #1, install the alternator onto the new alternator bracket and torque to 41 ft-lbs (55 Nm). Re-connect the alternator harness plug.

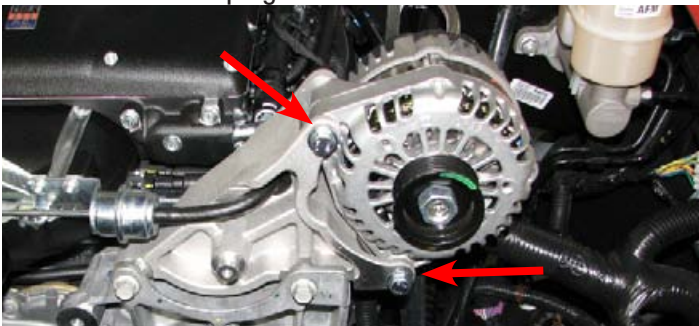

118. Remove factory alternator power cable and install supplied alternator power cable to factory location (**this may be on the firewall power junction or the positive battery terminal**). Then route cable behind manifold and connect it to alternator using a 10mm socket.



119. Route the supplied serpentine belt using the diagram below. Use a 15mm socket to release tension from the tensioner and re-tension after the belt is routed.

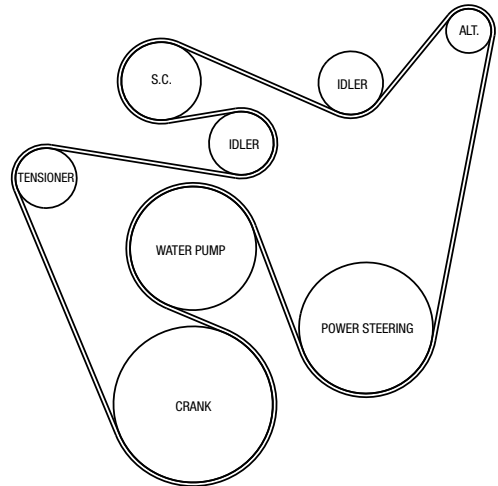

120. Using a 10mm socket, remove the factory throttle body from the factory intake manifold. Then carefully remove the throttle body gasket as it will be reused.

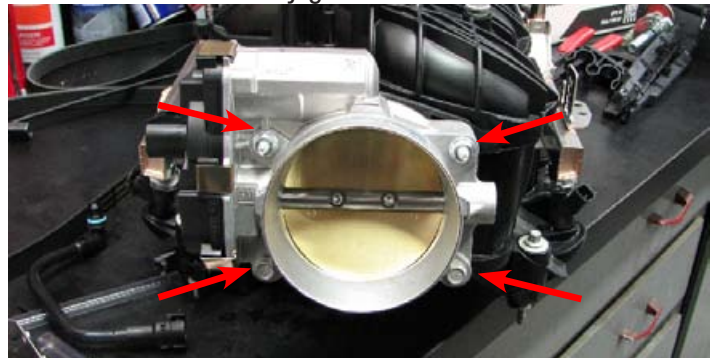



## Edelbrock Supercharger 2007-12 GM Trucks; 4.8l, 5.3l 6.0l, 6.2l

### Installation Instructions

121. Install the factory throttle body gasket onto the supercharger throttle body flange as shown.



122. Using the supplied M6 x 40mm bolts in Bag #1, install the factory throttle body onto the throttle body flange.



123. Using a Torx T25, remove the factory airbox cover.



124. Replace the factory air filter with the supplied Green filter.



125. Install the supplied silicone elbow onto the airbox cover, ensuring that the PVC port is facing down. Loosely secure using the supplied worm clamp.



126. Reinstall the top cover by slipping it onto the throttle body first. Then secure the top cover using a Torx T25 and the factory airbox screws. Re-align elbow for best fitment and tighten both worm clamps.

127. Connect the previously installed TMAP harness to the factory MAF plug and then to the factory MAF sensor. Now connect the MAP connector to the factory MAP harness. Reconnect the ETC harness to the throttle body.

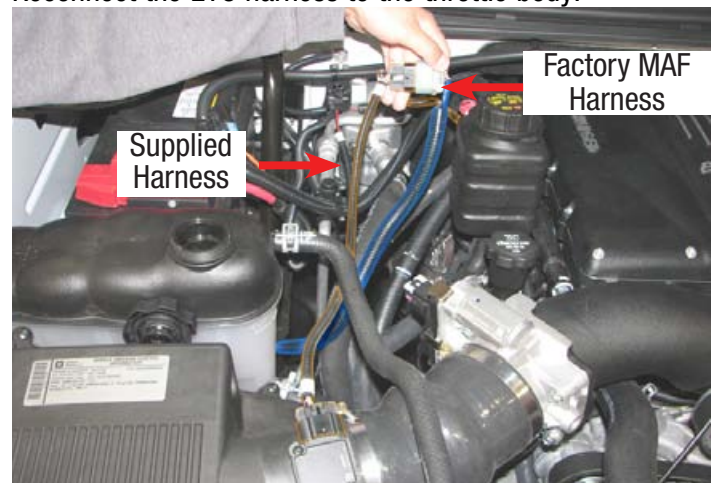



## Edelbrock Supercharger 2007-12 GM Trucks; 4.8l, 5.3l 6.0l, 6.2l

### Installation Instructions

**NOTE:** Proceed with Step 128 if your vehicle is equipped with a firewall mounted power junction. Otherwise, disregard and proceed to Step 129.

128. Using a 10mm socket, secure the fuse holder on the Water Pump harness to the left mounting stud of the power junction as shown below. Connect the POSITIVE (+) wire (orange) to the left junction terminal behind the factory power cable. Now mount the relay and GROUND (-) wire to the right stud of the power junction mounting stud as shown.

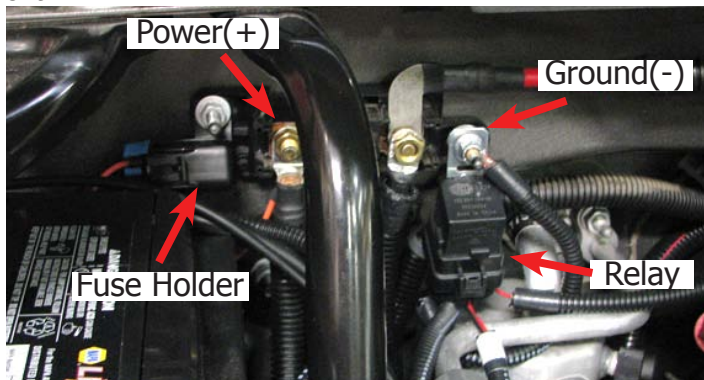

**NOTE:** Step 129 is for vehicles with battery mounted power junction. Disregard otherwise.

129. Remove the factory harness mounted on the stud on the firewall. Insert the relay GROUND (-) wire on the Water Pump harness to the stud on the firewall. Then mount the relay onto the same stud and secure with the supplied M6 nut from Bag #2. Re-mount the factory harness onto the stud. Now connect the POSITIVE (+) wire (orange) on the fuse holder to the positive terminal on the battery. Secure the fuse holder to the positive battery cable loom with a wire tie.

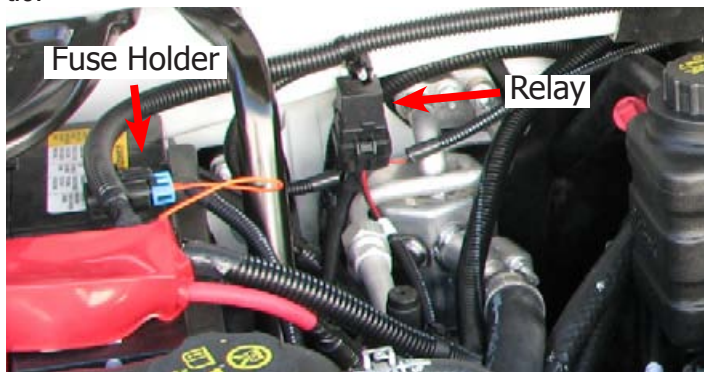

130. Route the EVAP solenoid connectors behind the manifold over towards the EVAP solenoid. Plug the female EVAP solenoid harness into the factory EVAP harness. Now plug the male connector into the EVAP solenoid.



131. Route the water pump connector down towards the water pump and connect it to the water pump. Secure the harness along the reservoir tank hose with wire ties.

132. Reinstall skid plate, front grill and upper radiator shroud.

133. Verify that the radiator petcock is reinstalled and refill the coolant system as needed.

134. Fill the intercooler recovery tank with a 50/50 blend of water and coolant. Fill the tank until the coolant mixture level is roughly 1" from the top of the threaded neck.

135. Reinstall the negative terminal on the battery.

136. Turn the ignition key to the 'ON' position but **DO NOT START THE VEHICLE YET.**

137. Carefully inspect the fuel rail, fuel hose fittings and coolant hoses for any leaks. If any leaks are detected, shut the engine off immediately and make any necessary repairs before continuing.

138. With the key in the "ON" position, verify that the coolant mixture is flowing briskly through the recovery tank, then install the cap. The intercooler pump will cycle and the water level may change. Repeat step 134 as necessary until proper mixture level is reached.



**Edelbrock Supercharger  
2007-12 GM Trucks; 4.8l, 5.3l 6.0l, 6.2l**

**Installation Instructions**

---

139. Check all fluid levels before operating vehicle.

Congratulations on the installation of your new Edelbrock E-Force Supercharger System. If you have any questions, please call our Technical Support hotline at 1-800-416-8628 and one of our technicians will be happy to assist you.