

LUND®

Interceptor™

**For proper installation and best possible fit, please read all instructions BEFORE you begin.
For technical assistance or to obtain missing parts, please call Customer Relations at 1-800-241-7219.**

Important Safety Information



- CAUTION - Before driving, ensure that the hood shield is properly secured to vehicle.
- Do not use automatic "brush-style" car washes.
- Do not use cleaning solvents of any kind.
- Periodically check all components for tightness.

Contents

NOTE: Actual product may vary from illustration.



Bugflector



Fastner x4



Bump On x4

Tools Required



Car Wash Supplies



Clean Towel

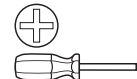

Phillips Screwdriver

Preparation Before Painting / Installation

- A trial fit is recommended to ensure proper positioning and fit.
- Check fit of parts before painting as we will not accept the return of modified or painted parts.
- Wash and dry your vehicle to remove any debris and/or dirt from the installation area.

Installation Steps

NOTE: Actual application may vary slightly from illustrations.

Raise hood.

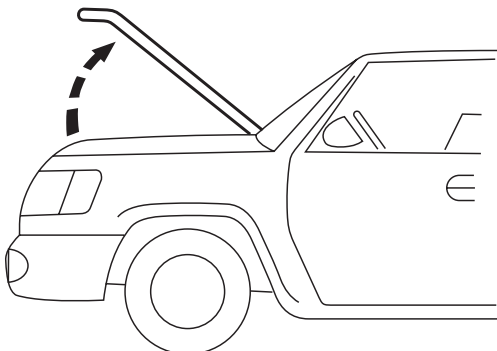

1

Locate 4 holes on underside of hood that align with the holes in hood shield and clean to remove any dust or debris.

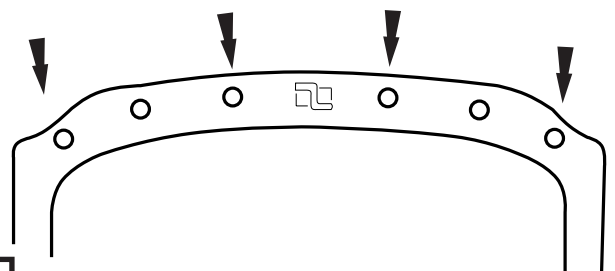

2

Installation Steps

NOTE: Actual application may vary slightly from drawings.

Align holes in hood shield with holes in underside of hood and position in place.

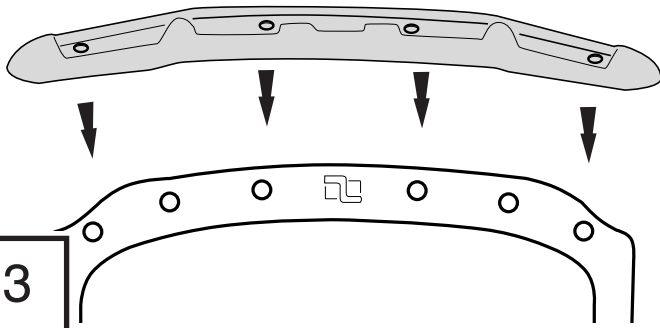

Install fasteners by either pushing or screwing.

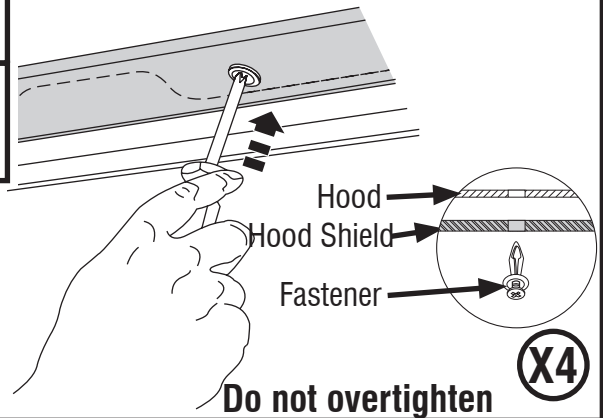

Close hood.

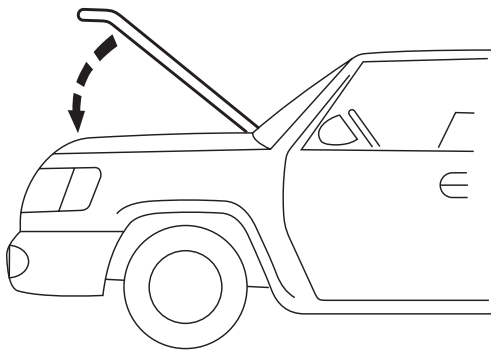

Install (4) bumpons on painted hood/fender surface.

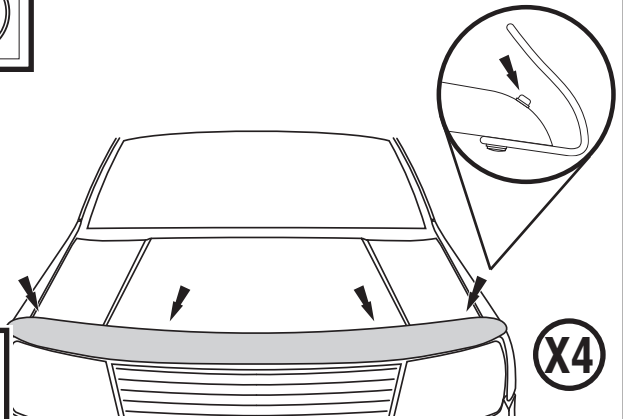

Care and Cleaning

- Wash only with mild soap & dry with a clean cloth.

Congratulations!

You have purchased one of the many quality Lund[®] branded products offered by Lund International, Inc. We take the utmost pride in our products and want you to enjoy years of satisfaction from your investment. We have made every effort to ensure that your product is top quality in terms of fit, durability, finish and ease of installation.

LUND[®]

Lund International

800-241-7219 • Visit us at lundinternational.com

© 2013 Lund International, Inc. All rights reserved.

Lund[®] and the Lund[®] logo are trademarks of Lund International, Inc.



LUND®

Interceptor™

Pour obtenir une installation correcte et le meilleur ajustement possible, lire toutes les instructions AVANT de commencer. Pour toute assistance technique ou obtention de pièces manquantes, appeler le service des relations avec la clientèle au 1-800-241-7219.

Informations importantes concernant la sécurité



- ATTENTION – Avant de conduire, s'assurer que le pare-insectes est solidement assujettie sur le véhicule.
- Ne pas utiliser les stations de lavage de voitures à brosses.
- Ne pas utiliser de solvants.
- Vérifier régulièrement le serrage des composants.

Contenu

NOTE: Le produit réel peut changer de l'illustration.



Pare-insectes



Attache (4)



Butoirs (4)

Outils nécessaires



Fournitures pour lavage de voiture



Serviette propre

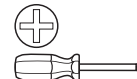

Tournevis Phillips

Préparation pour la peinture/l'installation

- Il est recommandé de procéder à un essai pour s'assurer que le positionnement et l'ajustement sont corrects.
- Vérifier l'ajustement des pièces avant peinture, car nous n'acceptons pas le retour de pièces modifiées ou peintes.
- Laver les glissières de glaces de la portière du véhicule pour éliminer toute poussière et tous débris.
- Sécher les glissières avec une serviette propre.

Étapes d'installation

REMARQUE : La méthode d'application peut être légèrement différente de celle représentée par les illustrations.

Ouvrir le capot.

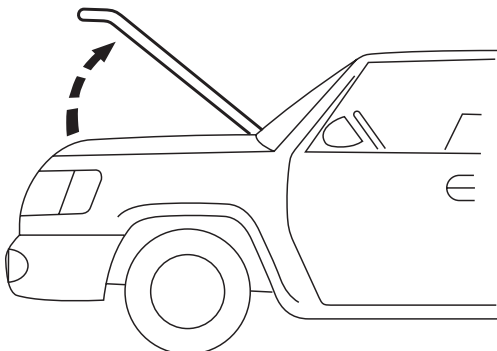

1

Localiser les 4 trous, sur le dessous du capot, qui s'alignent sur ceux du pare-insectes et les nettoyer pour éliminer la poussière et les débris.

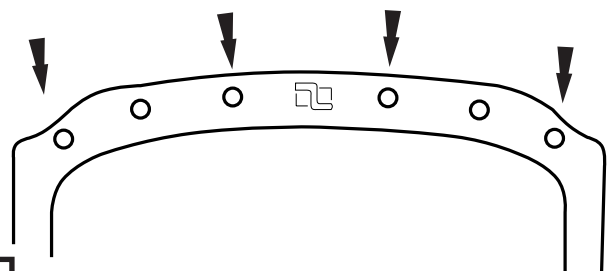

2

Étapes d'installation

REMARQUE : La méthode d'application peut être légèrement différente de celle représentée par les illustrations.

Aligner les trous du pare-insectes et ceux du dessous du capot et mettre le pare-insectes en place.

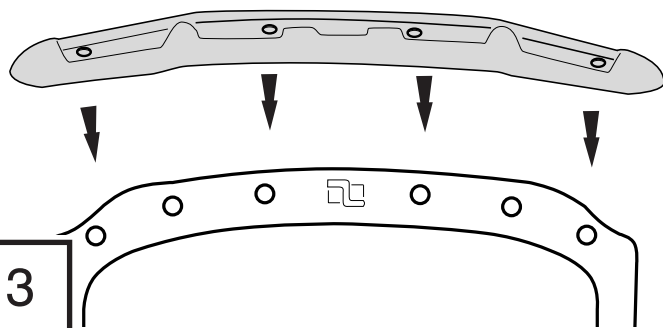

Installer les fixations en les poussant ou en les vissant.

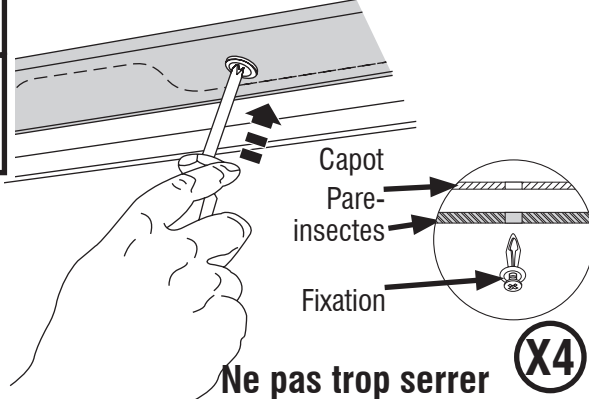

Fermer le capot.

5

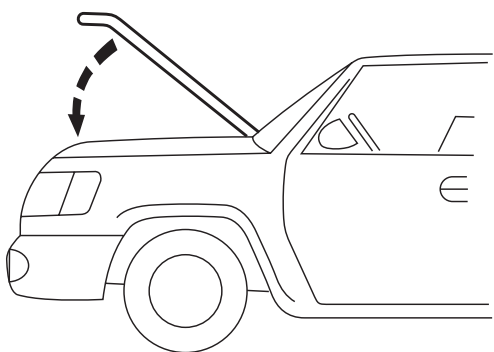

6

Installer (4) butoirs sur la surface peinte du capot / de l'aile.

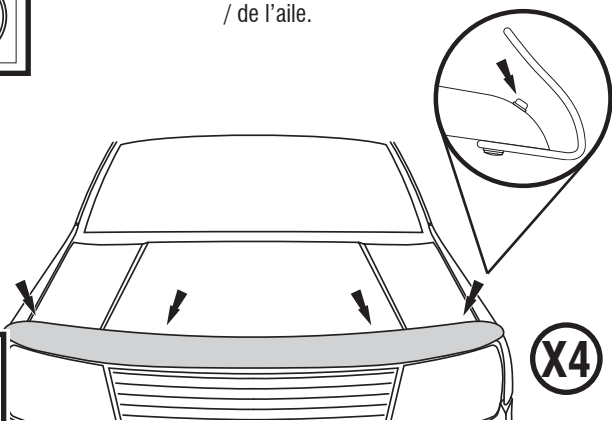

Entretien et nettoyage

- Laver exclusivement avec de l'eau savonneuse et sécher avec un chiffon propre.

Félicitations !

Vous venez d'acheter un des nombreux produits de qualité de la marque Lund[®] fabriqués par Lund International, Inc. Nous sommes extrêmement fiers de la qualité de nos produits et nous espérons que vous profiterez de cet investissement de longues années durant. Nous nous efforçons d'offrir la meilleure qualité en termes d'ajustement, de finition, de durabilité et de facilité d'installation.

LUND[®]

Lund International

800-241-7219 • Visitez notre site lundinternational.com

© 2013 Lund International, Inc. Tous droits réservés.

Lund[®] et le logo Lund[®] sont des marques déposées de Lund International, Inc.



LUND®

Interceptor™

Para una instalación adecuada y el mejor ajuste posible, lea todas las instrucciones ANTES de comenzar. Si desea recibir asistencia técnica u obtener piezas faltantes, llame al Servicio al cliente al 1-800-241-7219.

Información importante de seguridad



- PRECAUCIÓN - Antes de conducir, asegúrese de que la visera deflectora esté correctamente anclada al vehículo.
- No utilice servicios automáticos de limpieza de vehículos que utilizan cepillos.
- No utilice limpiadores al solvente de ningún tipo.
- Compruebe periódicamente que todos los componentes estén ajustados.

Contenido

NOTA: El producto real puede variar de la ilustración.



Cubierta para capó



Sujetador x4



Soporte x 4

Herramientas necesarias



Equipo de limpieza de vehículos



Toalla limpia

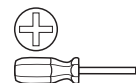

Destornillador Phillips

Preparación antes de pintar o instalar

- Se recomienda realizar un ajuste de prueba para asegurar el posicionamiento y ajuste correctos.
- Compruebe que las piezas se ajusten correctamente antes de pintarlas, ya que no aceptaremos la devolución de piezas modificadas o pintadas.
- Lave los canales de la ventanilla del vehículo para quitar los desechos y la suciedad.
- Seque los canales de la ventanilla con una toalla limpia.

Pasos de instalación

NOTA: El uso real puede variar levemente de ilustraciones.

Levante el capó.

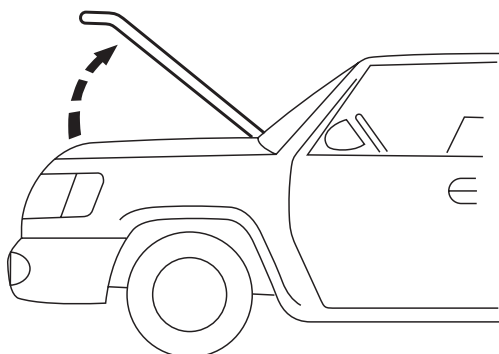

1

Ubique los 4 orificios en la parte inferior del capó que se alinean con los orificios de la cubierta para capó y límpielos para retirar el polvo y los desechos.

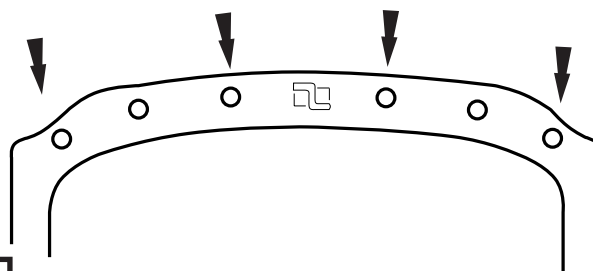

2

Pasos de instalación

NOTA: El uso real puede variar levemente de ilustraciones.

Alinee los orificios de la cubierta para capó con los orificios de la parte inferior del capó y coloque la cubierta en su lugar.

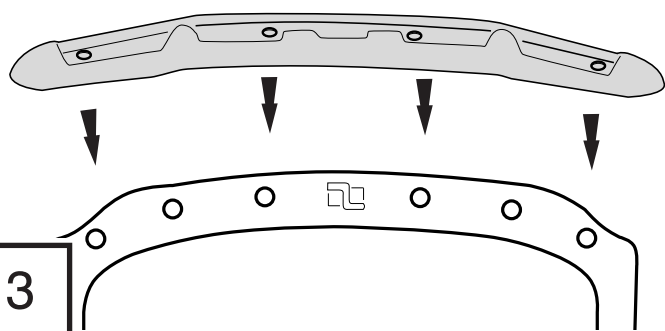

Instale los sujetadores empujando o atornillando.

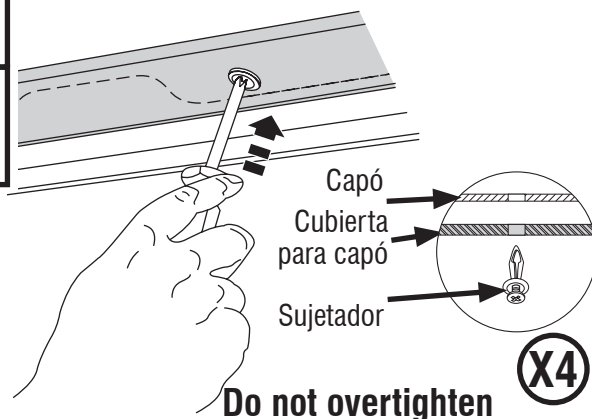

Cierre el capó.

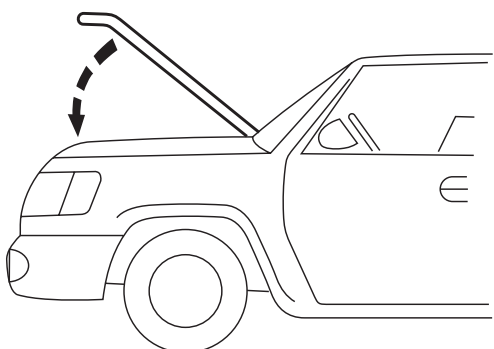

Instale (4) soportes en el capó pintado / la superficie del guardabarros.



6

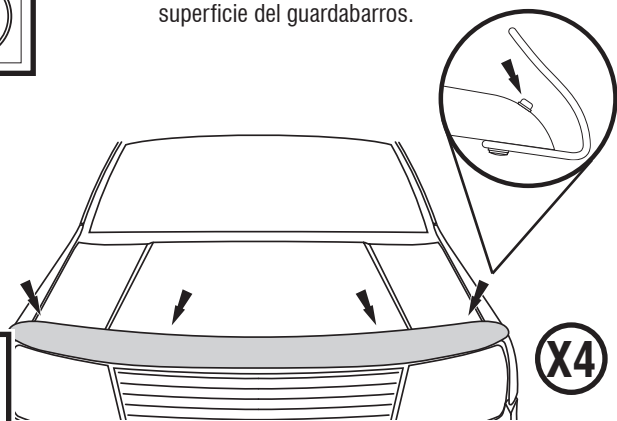

Cuidado y limpieza

- Limpie solamente con agua jabonosa tibia y seque con un paño limpio.

Felicidades

Usted ha adquirido uno de los tantos productos de calidad de marca Lund[®] que ofrece Lund International, Inc. Nos enorgullecen mucho nuestros productos y deseamos que disfrute años de satisfacción por su inversión. Nos hemos esforzado mucho para asegurarnos de que su producto sea de gran calidad en cuanto a ajuste, durabilidad, acabado y facilidad de instalación.

LUND[®]

Lund International

800-241-7219 • Visite nuestro sitio Web: lundinternational.com

© 2013 Lund International, Inc. Todos los derechos reservados.

Lund[®] y el logo de Lund[®] son marcas registradas de Lund International, Inc.

