

ROUGH COUNTRY
SUSPENSION SYSTEMS®

921360300C



36030BAG8

Dodge 2019 2500 5" Radius Arm Lift Kit

Thank you for choosing Rough Country Suspension for your Off Road needs.

Rough Country recommends a certified technician install this system. In addition to these instructions, professional knowledge of disassemble/reassembly procedures as well as post installation checks must be known. Attempts to install this system without this knowledge and expertise may jeopardize the integrity and/or operating safety of the vehicle. Average professional install time for this kit is 4-6 hours.

Please read all the instructions before beginning the installation. Check the kit hardware against the kit contents list on the last page. Be sure you have all the needed parts and understand where they go.

⚠ WARNING

Product Use Information

As a general rule, the taller a vehicle is the easier it will roll. We strongly recommend, because of roll-over possibility, that the vehicle be equipped with a functional roll-bar and cage system. Seat belts and should harnesses should be worn at all times. Avoid situations where a side rollover may occur.

Also check the steering stabilizer. It is a good idea when adding larger than stock tires to go with a larger bore steering stabilizer or a dual unit for tires 35" and above. Inspect the stabilizer and replace as necessary.

Braking performance and capability are decreased when significantly large/heavier tires and wheels are used. Take this into consideration while driving.

Do not add, alter, or fabricate any factory or after-market parts which increase vehicle height over the intended height of the Rough Country product purchased. Mixing component brands, lifts, and/or combining body lift with suspension lifts voids all warranties. Rough Country makes no claims regarding lifting devices and excludes any and all implied claims. We will not be responsible for any product that is altered.

This suspension system was developed for 37x12.50 tire on an aftermarket wheel with a minimum of 5" back spacing. When larger tires are installed, speedometer recalibration is necessary. Due to ride height inconsistencies from the factory you may need to slightly trim the front plastic valance for proper tire clearance.

⚠ NOTICE On vehicles equipped with a two piece driveshaft & carrier bearing as on the Mega Cab, there is the potential for take off vibration, depending on the severity this can be corrected with shim-ming down the carrier bearing. Carrier bearing drop kit Part # 1110 is available from Rough Country.

⚠ NOTICE Notice to Dealer and Vehicle Owner

Any vehicle equipped with any Rough country product must have the "Warning to Driver" decal installed on the sun visor or dash. The decal is to act as a constant reminder for whoever is operating the vehicle of its unique handling characteristics. **INSTALLING DEALER—It is your responsibility to install the warning decal and to forward these installation instructions to the vehicle owner for review and to be kept in the vehicle for its service life.**

Tools and Supplies Needed to Install Kit

1. Torque Wrench	8. Pitman Arm Puller
2. ½" Drive Ratchet and Sockets	9. Hammers
3. Assorted Combination Wrenches	10. C-Clamps
4. Heavy Duty Jack Stands	11. Center Punch
5. Hydraulic Floor Jacks	12. 17/32" Drill Bit
6. Locking Pliers	13. 9/16" Drill Bit
7. Anti-Seize Compound	14. 15/32" Drill Bit



Kit Contents:	Poly Bags:
---------------	------------

9299:

2-Front Coil Springs

36030Box1:

- 1-Front Track Bar Bracket
- 2-Front Sway Bar Brackets
- 1-Pitman Arm (6625)
- 2-Poly Bump Stops
- 1-Dr Brake Line Bracket
- 1-Pass Brake Line Bracket
- 1-Dr Sway Bar Drop Bracket
- 1-Pass Sway Bar Drop Bracket
- 1-E-Brake Bracket (Not Used w/ Factory Electric E-Brake)
- 1-E-Brake Cable Extension (Not Used w/ Factory Electric E-Brake)
- 1-36030BAG8 (Instructions)
- 1-36030BAG3

39830Box4:

- 2-Rear Coil Spring Spacers
- 1-Rear Track Bar Bracket
- 2-Rear Sway Bar Links
- 2-Rear Bump Stop Brackets
- 1-39830BAG5

36030Box2:

- 2-Front Shock Absorbers (660783)
- 2-Rear Shock Absorbers (660801)

1368Box1:

- 1-Driver Radius Arm

1368Box2:

- 1-Passenger Radius Arm

36030Box3:

- 1-Transmission Crossmember
- 1-Transfer Case Skid Plate
- 1-T-Case Wire Loom Bracket
- 1-T-Case Clocking Ring
- 1-36030BAG2

36030Bag3:

- 8-7/16" Flat Washers
- 2-5/16" Nylock Nuts
- 2-5/16" x .75" Bolts
- 4-7/16" x 1.25" Bolts
- 4-7/16" Nylock Nuts
- 2-5/16" Flat Washers
- 2-14mm Nylock Nuts
- 2-14mm Flat Washers

39830Bag5:

- 1-1/2" x 1.5" Bolt
- 10-1/2" Flat Washers
- 2-1/2" Top Lock Nuts
- 4-3/8" x 1.25" Bolts
- 12-3/8" Flat Washers
- 4-3/8" Nylock Nuts
- 1-9/16" x 4.5" Bolt
- 2-9/16" Flat Washer
- 1-9/16" Nut
- 1-1/2" x 1.25" Bolt
- 4-12mm x 75mm Bolts
- 4-12mm Lock Nuts
- 4-10mm x 100mm Bolts
- 1-Rear Track Bar Bracket Sleeve

36030Bag2:

- 2-14mm x 200mm Bolts
- 2-14mm Nylock Nuts
- 4-14mm Flat Washers
- 2-3/8" x 1.25" Bolts
- 2-3/8" Flat Washers
- 6-10mm Serrated Flange Nuts
- 6-10mm x 41mm Double End Studs
- 6-10mm x 30mm Flat Head Bolts
- 2-1/4" Flat Washers
- 1-1/4" Nylock Nut
- 1-1/4" x 1" Bolt

Torque Specs:

Size	Grade 5	Grade 8	Size	Class 8.8	Class 10.9
5/16"	15 ft/lbs	20ft/lbs	6MM	5ft/lbs	9ft/lbs
3/8"	30 ft/lbs	35ft/lbs	8MM	18ft/lbs	23ft/lbs
7/16"	45 ft/lbs	60ft/lbs	10MM	32ft/lbs	45ft/lbs
1/2"	65 ft/lbs	90ft/lbs	12MM	55ft/lbs	75ft/lbs
9/16"	95 ft/lbs	130ft/lbs	14MM	85ft/lbs	120ft/lbs
5/8"	135ft/lbs	175ft/lbs	16MM	130ft/lbs	165ft/lbs
3/4"	185ft/lbs	280ft/lbs	18MM	170ft/lbs	240ft/lbs



36030

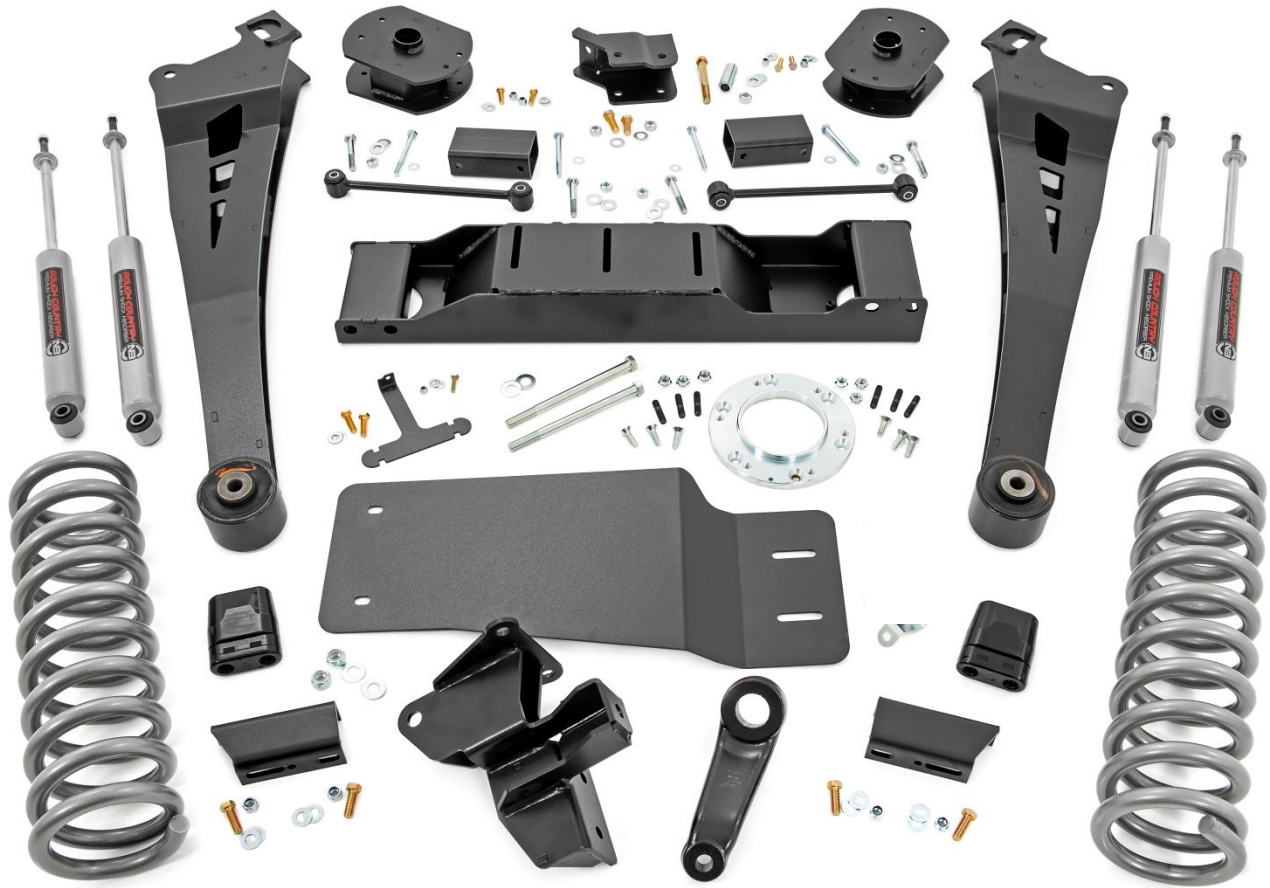

FRONT SUSPENSION INSTALLATION

1. Secure and block the rear tires of the vehicle on a level concrete or asphalt surface
2. Raise the front of the vehicle and support the frame with jack stands. Remove the front wheels and tires and set aside. Position a hydraulic jack under the front axle and raise the jack until the front suspension begins to compress
3. On both sides of the vehicle, scribe alignment marks on the adjustment cam and axle bracket at the lower axle bolt of the radius arm for later reference.
4. Unbolt the brake line brackets from the inside of the frame using a 13mm wrench to ensure brake line free play during the suspension system installation. **See Photo 1.** Retain stock hardware for later use.
5. Unplug the electrical connector for the four wheel drive engagement. **See Photo 2.**
6. Using a 15mm wrench, remove the bolts from the front driveshaft at the pinion flange. Retain hardware. **Do not allow the driveshaft to hang by the Rzeppa joint, this can cause damage to the joint. Place a jack under the driveshaft or use wire to tie it up.**

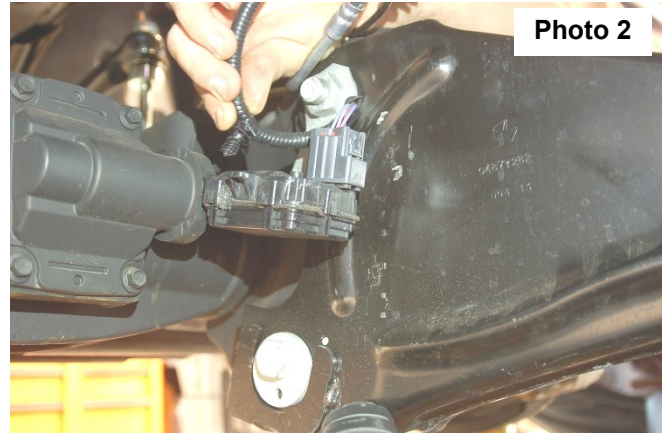
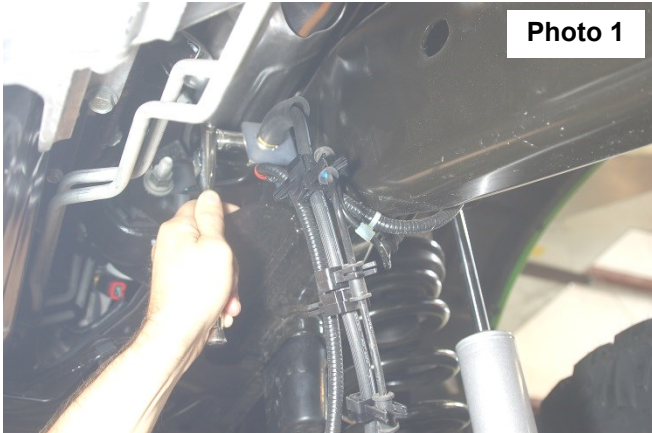

7. Remove the sway bar links by unbolting the lower sway bar nut as shown in **Photo 3** using a 10mm socket and a 21mm wrench. Retain hardware.
8. Remove the track bar from its upper mounting point on the frame using a 1 1/16" wrench and rest it on the axle. It may be helpful to loosen the lower track bar bolt on the axle. Retain hardware for reuse.
9. Remove the cotter pin, and castle nut from the drag link where it connects to the pitman arm. A pitman arm tool may be needed to separate the drag link from the pitman arm. Remove the stock nut, and lock washer from the sector shaft on the steering box. Save hardware for later installation. Using a pitman arm puller carefully remove the stock pitman arm.
10. Remove the front shocks with a 18mm wrench for the upper stud and a 21mm socket for the lower bolt. **See Photo 4.** Retain lower shock mount factory hardware.

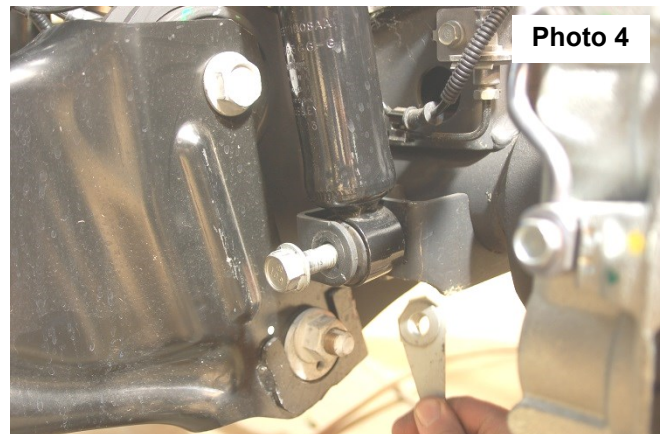
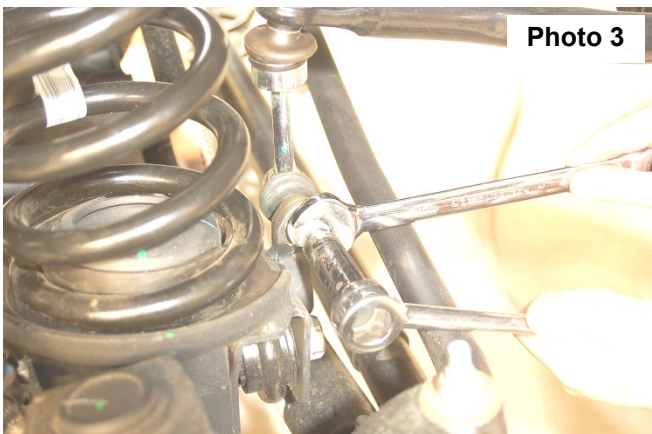

11. Lower the axle and remove the coil springs. Note there is a rubber push pin made on to the factory coil isolator to align the coil spring. Push on the top the pin to release the isolator from the frame coil pocket.
12. Using a 24mm socket and wrench remove the two bolts holding the driver radius arm to the axle. Retain factory hardware.
13. Next remove the radius arm bushing bolt with a 27mm socket and wrench. Retain factory hardware.

14. Install the supplied driver side radius arm with factory hardware. **See Photo 5.** Note the offset side of the radius arm goes to the outside of the truck. Do not tighten the radius arm bushing bolt until the truck is sitting on the ground.
15. Repeat steps 12-14 on the passenger side.
16. Use the supplied template to rotate the spring isolator **on the pass side only.**
17. Install the supplied lifted coil springs, making sure the coil is properly seated in the upper and lower coil seats.
18. Install the new front shocks, #660783, using the supplied bushings for the top mount. Using an 18mm, torque to 30 ft-lbs. or just until the bushings start to bulge under the washers.
19. Install the shock in the lower mount using the factory hardware. Torque to 88ft-lbs using a 21mm socket. **See Photo 6.**

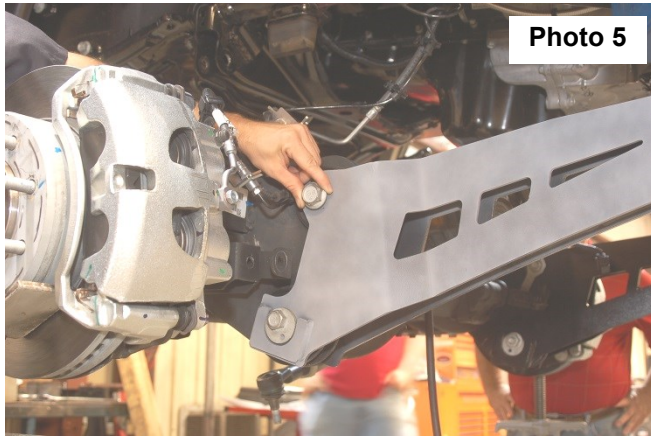

Photo 5

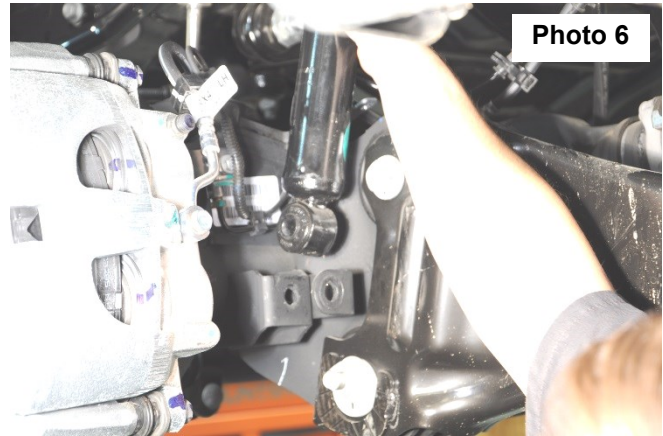

Photo 6

20. Remove the factory bump stop and replace it with the new supplied longer poly bump stop. **See Photo 7.**
21. Install the supplied 6625 pitman arm onto the stock sector shaft using the factory hardware, apply thread locker and torque to 400 ft-lbs.
22. Using a 21mm socket, remove the 5 bolts securing the factory track bar bracket to the frame. Retain hardware. **See Photo 8.**

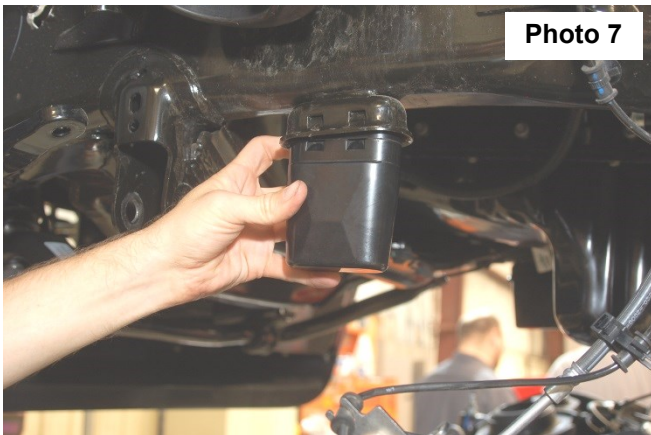

Photo 7

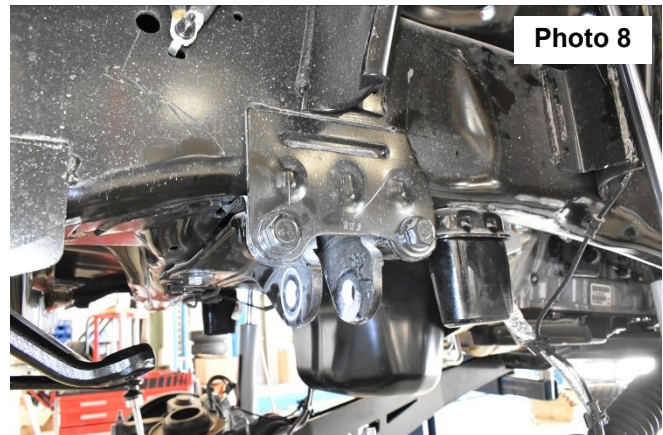

Photo 8

23. Install the supplied track bar bracket to the factory mount using the factory bolts. The (2) horizontal factory mounting bolts will use (2) supplied 14mm nylock nuts and washers (36030BAG3). Torque to 120ft-lbs using a 21mm socket and wrench. **See Photo 9.**
24. **The track rod will be installed into the new mount after the vehicle is on the ground.**
25. Remove the sway bar hardware using an 18mm wrench as shown in **Photo 10** and allow the sway bar to separate

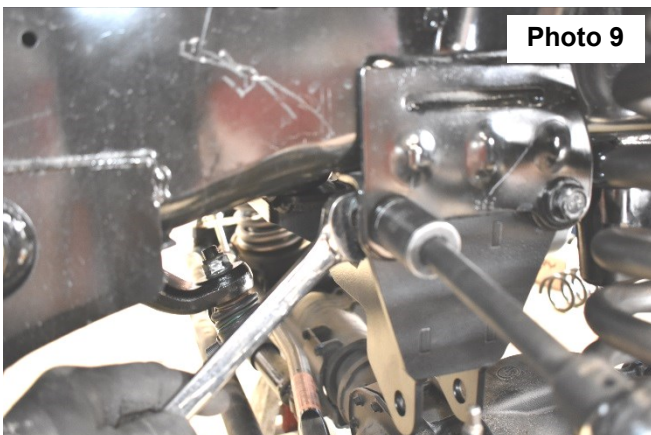

Photo 9



Photo 10

26. Install the sway bar drop bracket and secure to the frame using the factory hardware. Using an 18mm, torque to 55ft-lbs.
27. Install the sway bar to the new bracket with the supplied 7/16" x 1 1/4" bolts, flat washers and nuts (36030BAG3). **See Photo 11.** Torque to 60ft/lbs using a 9/16" socket and wrench.
28. Install the front **Driver Side (2 Bends)** brake line bracket to the frame using factory hardware, Torque to 15ft-lbs. **See Photo 12.** Attach the brake line mount to the new bracket with the supplied 5/16" x 3/4" bolts, washer, and nuts (36030BAG3). Torque to 15ft-lbs with a 13mm socket and wrench.

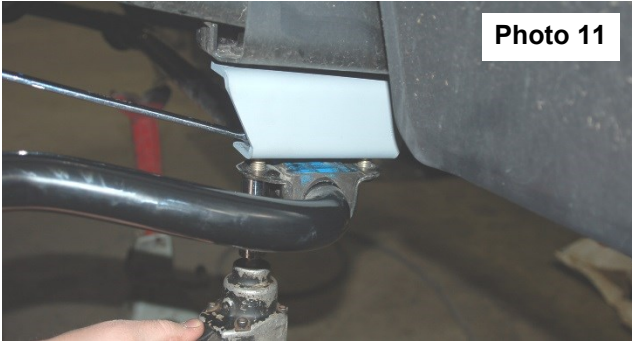

Photo 11



Photo 12

29. Attach the brake line mount to the new bracket with the supplied 5/16" x 3/4" bolts, washer, and nuts (36030BAG3). Torque to 15ft-lbs with a 13mm socket and wrench. Install the front **Passenger Side (1 Bend)** brake line bracket with bend at bottom away from frame, use factory hardware, Torque to 15ft-lbs. **See Photo 13.**

30. Install the tires / wheels and then lower the truck to the ground.
31. Install the track rod in the new bracket using the factory hardware. Torque to 170ft/lbs using a 1 1/16" socket and wrench.
32. Torque the radius arm bolt, to 270 ft-lbs, with a 1 1/16" socket.



Photo 13

33. Remove the outer tie rod end from the steering link by rotating the adjuster until the end can be removed. Use a suitable cutting tool and remove the flat off the tie rod end. Photo 14
34. Reinstall the outer tie rod end back to the adjuster in the approximate location that it was removed. Install to the new pitman arm upside down using the factory hardware from the OEM orientation as shown. Torque the nut to 65 ft-lbs.



Photo 14

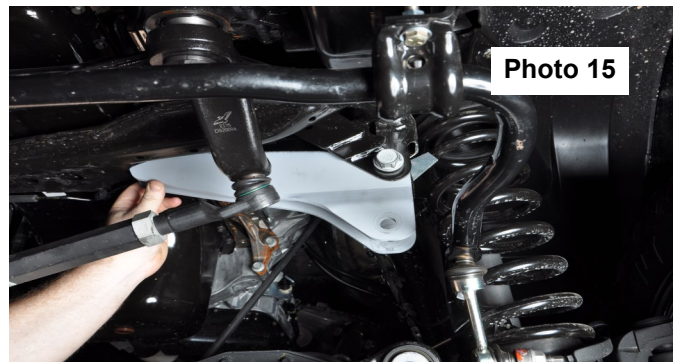
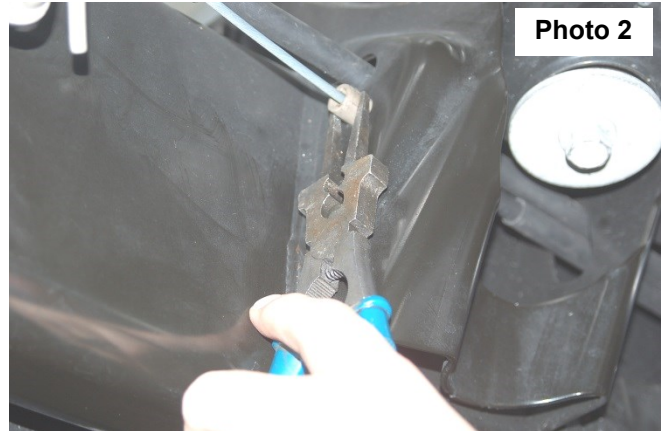
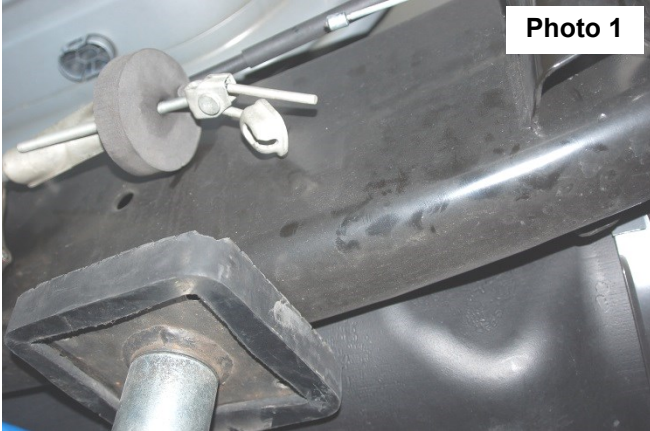

Photo 15

REAR INSTALLATION

1. Secure and block the front tires of the vehicle on a level concrete or asphalt surface.
2. Using a 21mm wrench remove the track bar bolt on the frame. Raise the rear of the vehicle and support the frame with jack stands. Remove the rear wheels and tires and set aside.
3. **Electric E-Brake Equipped Models skip to step 9.** Un-couple the e-brake cable on the drivers side of the vehicle. **See Photo 1.**
4. Remove the cable from the body mount using pliers to release the cable clips as shown in **Photo 2.**



5. Remove the cable and place the supplied drilling template in place, making sure the template has the new hole placed directly below factory hole. The template may be tapped in place. **See Photo 3.**
6. Drill the new hole as shown using a 9/16" drill bit. **See Photo 4.**

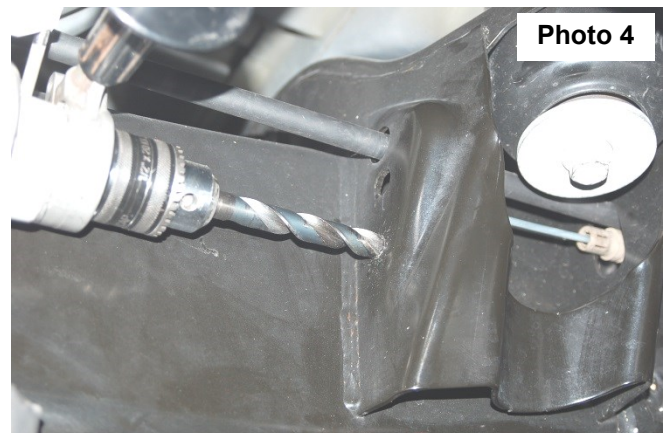

7. Install the e-brake line bracket on the e-brake line as shown in **Photo 5**, making sure the bracket snaps into place.
8. Install the supplied brake line bracket as shown in **Photo 6** with the supplied 1/2" x 1 1/2" bolts, flat washers and lock nut (39830BAG5). Torque to 65 ft-lbs. using a 19mm wrench / socket.

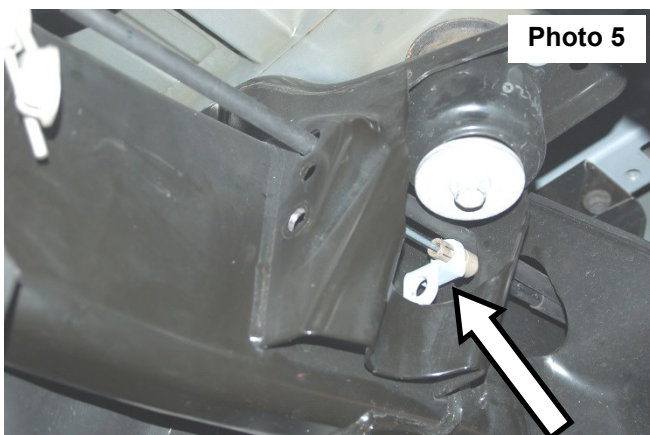

9. Remove the inner fender well using a 8mm socket. 11 bolts to remove. One of the bolts is hidden behind the fender flare on the front side.
10. Remove the rear shock with a 21mm wrench for the lower and a 18mm wrench for the upper mount.
11. Using a 18mm wrench and socket remove the sway bar link.
12. Lower the axle and remove the coil spring and spring isolator.
13. Install new spacer on axle with the shorter side to the front of the truck, secure spacer to axle using supplied 3/8" bolts, nuts, and washers (39830BAG5) . Torque to 35 ft-lbs. using 9/16" wrenches. **See Photo 7** Install coil spring and spring isolator onto lower coil spacer, raise axle making sure spring is seated properly on top and bottom.
14. Measure 3/4" from the bottom of the bracket and mark a line. Using a saw cut the end of the track bar bracket off as shown in **Photo 8**. Note you will only cut the one tab.

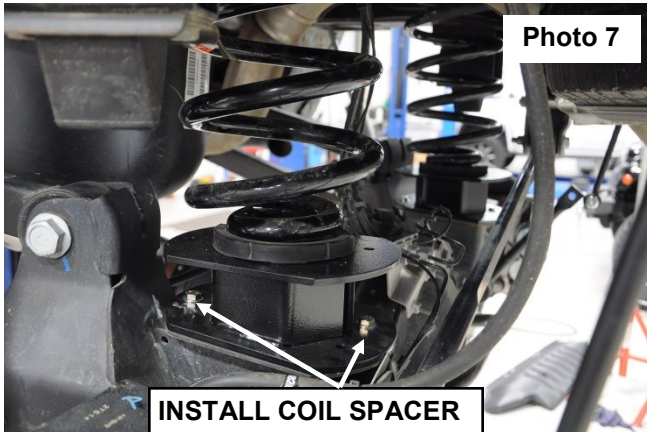

15. Install the new supplied track bar bracket with the crush sleeve using the supplied 9/16" x 4.5" bolt, washers, and nut (39830BAG5). Hand tighten. Use the bracket has a template and drill the hole using a 17/32" drill bit. Next install the 1/2" x 1.25" bolt and nut (39830BAG5) in the drilled hole. Torque the 9/16" bolt to 130ft/lbs with a 13/16" socket & wrench and torque the 1/2" bolt to 90ft/lbs with a 3/4" socket and wrench. **See Photo 9**.
16. Install the new rear shock absorbers part # 660801 with the supplied stem bushings. Torque to 30 ft-lbs. with a

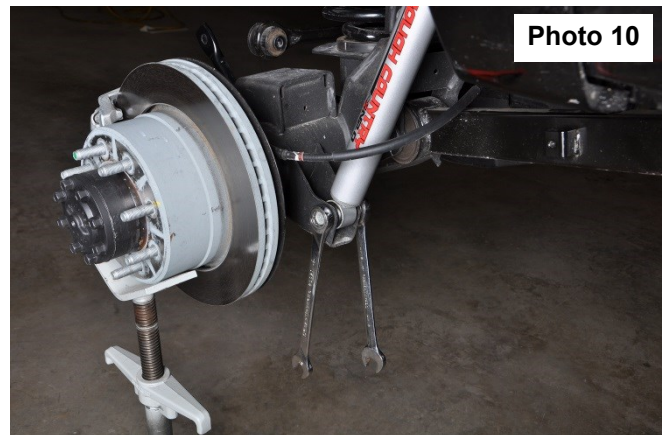
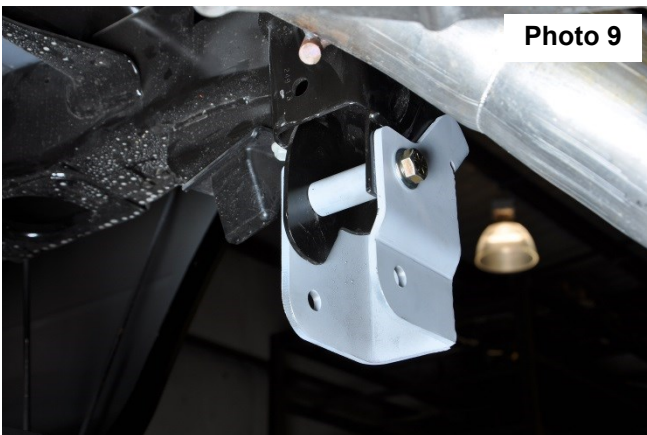

19mm for the top and Torque to 88 ft-lbs. using a 21mm for the lower bolt. **See Photo 10**.

17. Next install the rear sway bar links, to the inside of the frame mount and the sway bar, using the supplied 12mm x 75mm bolts, lock nuts, and washers (39830BAG5). Torque to 75ft/lbs with a 18mm and 19mm wrench. **See Photo 11.**
18. Using a 15mm socket remove the rear bump stop from the frame. Place the bump stop extensions between the bump stop and the frame and secure with the supplied 10mm x 100mm bolts and washers (39830BAG5). **See Photo 12.** Torque to 32ft/lbs with a 17mm socket.
19. Reinstall the inner fender wells using the factory hardware and a 8mm socket.



Photo 11

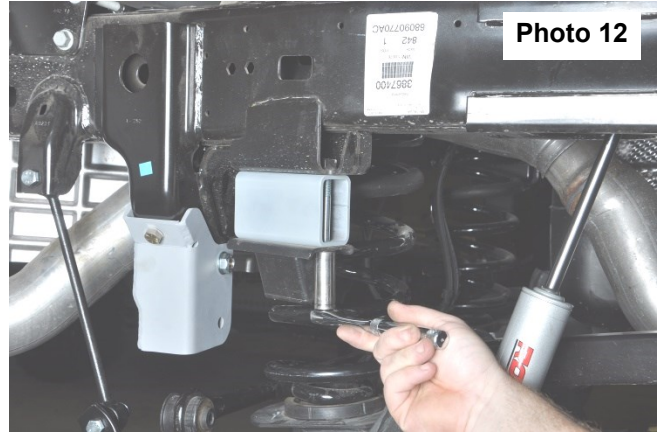

Photo 12

20. Install the wheels / tires.
21. Using a 15mm wrench, remove the rear driveshaft from the rear pinion flange. Retain hardware. **See Photo 13.**
22. Using a pry tool, remove the wiring clips from the transfer case housing. **See Photo 14.**



Photo 13

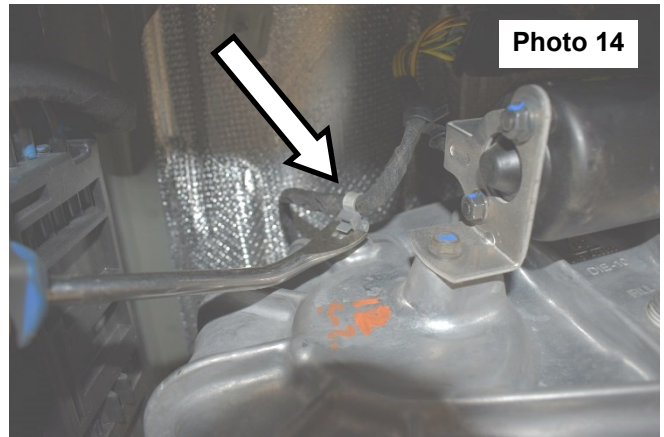

Photo 14

23. Unplug all wiring harnesses from the transfer case. **See**

Photo 15.

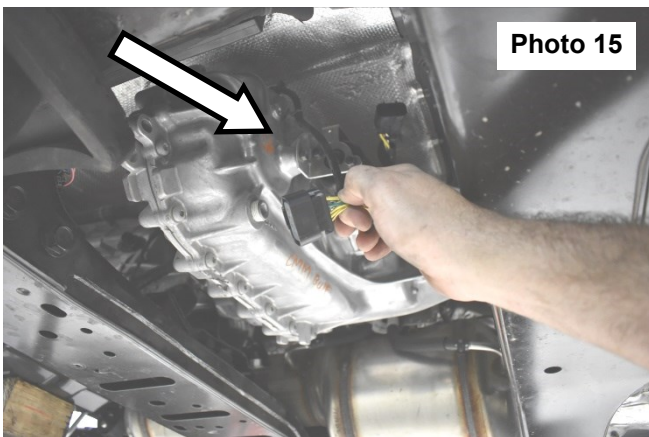

Photo 15

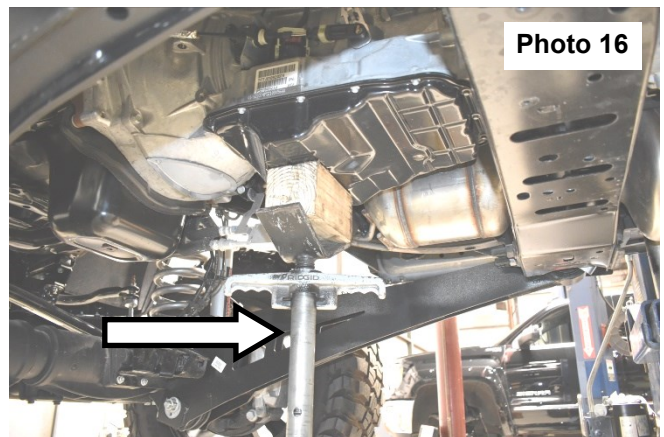
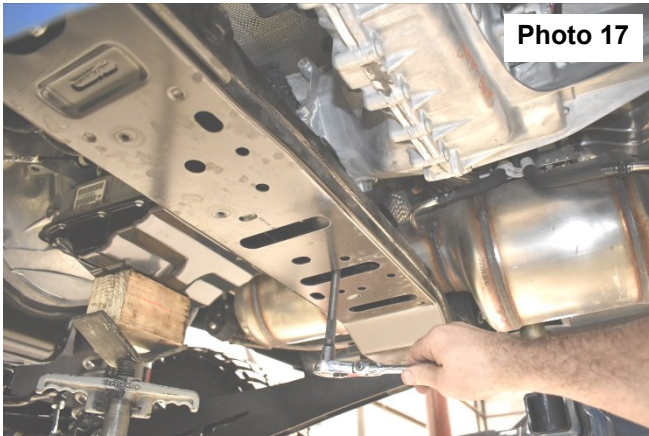
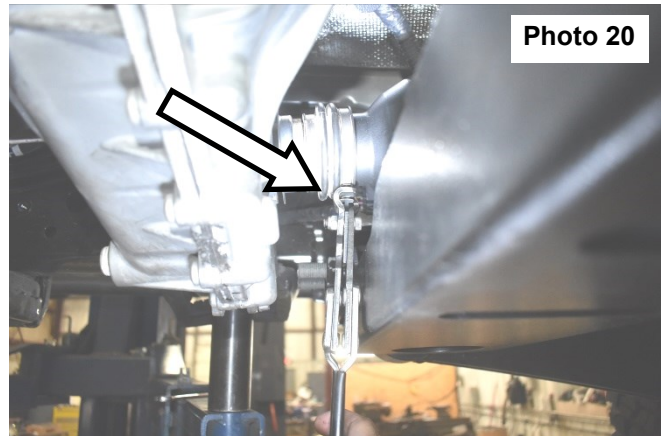
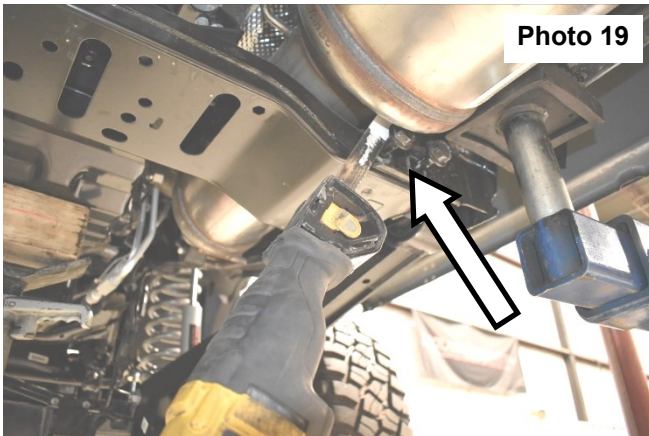

Photo 16

24. Using a jack stand, support the transmission. **See Photo 16.**
25. Using a 13mm socket, remove the (3) nuts from the bottom of the transfer case crossmember. Retain hardware. **See Photo 17.**
26. Using 24mm wrenches, remove the transfer case crossmember hardware. The passenger side bolts will have to be



27. Using a pair of pliers release the front clamp on the front driveshaft dust boot, at the transfer case. **See Photo 20.**



28. Roll the dust boot towards the transfer case.
29. Using snap ring pliers, spread the snap ring and slide the driveshaft towards the front of the truck. **See Photo 21.**
30. Remove the front driveshaft and set aside.
31. Using a 15mm wrench, remove the (3) rear bolts from the transfer case crossmember mount. Retain hardware.

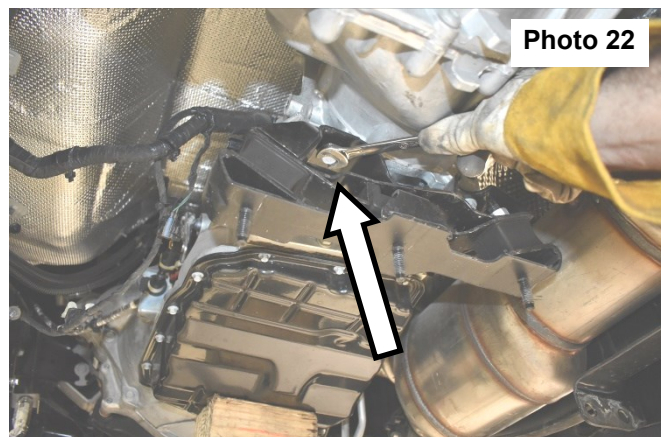
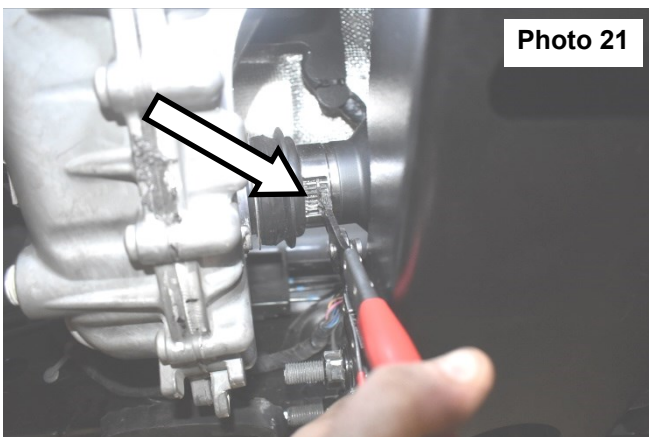

See Photo 22.

32. Using a 15mm socket, remove the (2) front transfer case crossmember mount bolts and remove the mount. Retain hardware. **See Photo 23.**
33. Place a jack/transmission jack under the transfer case.
34. Using a 15mm wrench and 15mm socket, remove the nuts from the transfer case mounting studs. Retain for reuse.

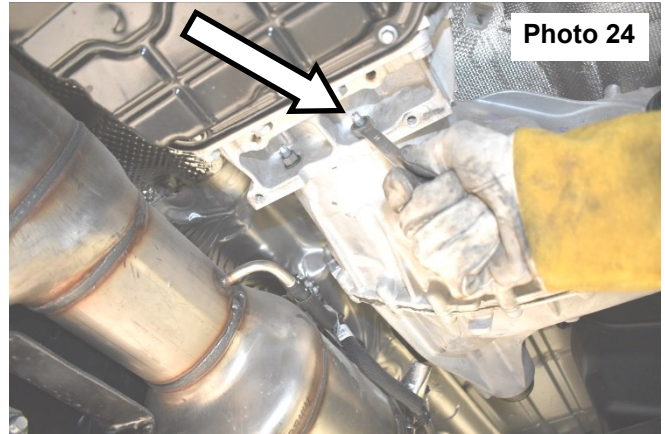
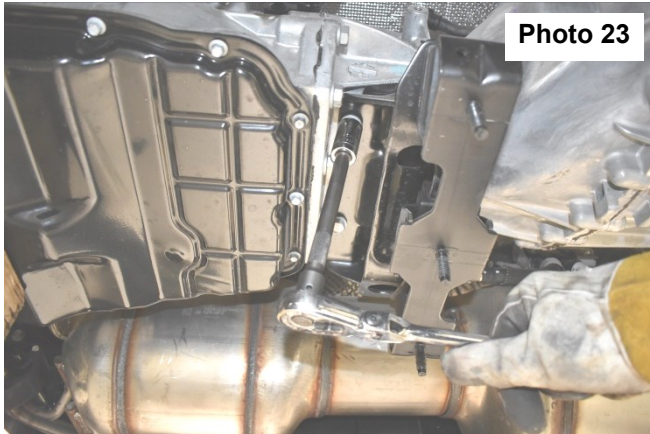

See Photo 24.

35. Carefully remove the transfer case from the truck.
36. Using an E9 torx, remove the (6) transfer case studs from the transfer case. **See Photo 25.**
37. Install the supplied clocking ring on the transfer case (**through hole will go to the top**) using the (6) supplied 10mm x 30mm flat head bolts (36030BAG2). Apply a thread locker to the bolts and torque to 45ft/lbs using a 6mm

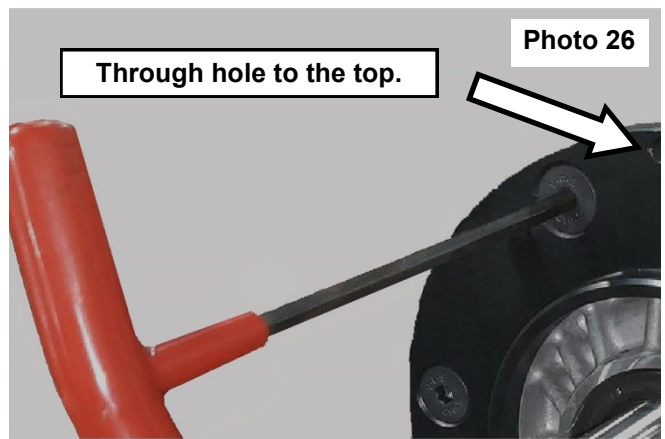
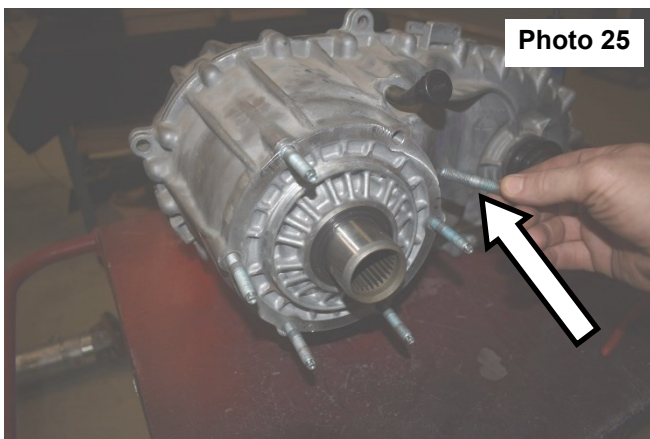

Allen. See Photo 26.

38. Apply a thread locker to the (6) supplied double ended 10mm studs (36030BAG2), snug them using pliers. Allow the thread locker to set before proceeding to the next step. **See Photo 27.**
39. Install the transfer case using the (6) supplied 10mm flange nuts (36030BAG2). Tighten using a 15mm wrench.

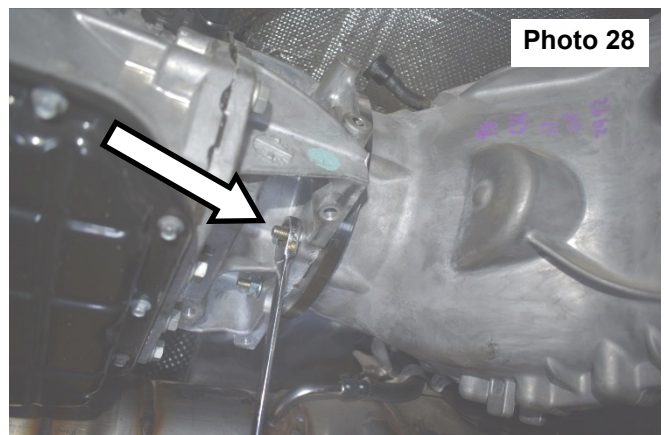
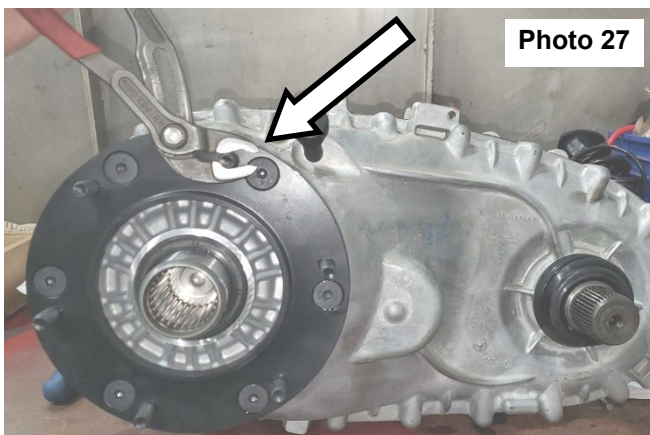

See Photo 28.

40. Install the transfer case crossmember mount using the factory hardware. Torque to 45ft/lbs using a 15mm socket.

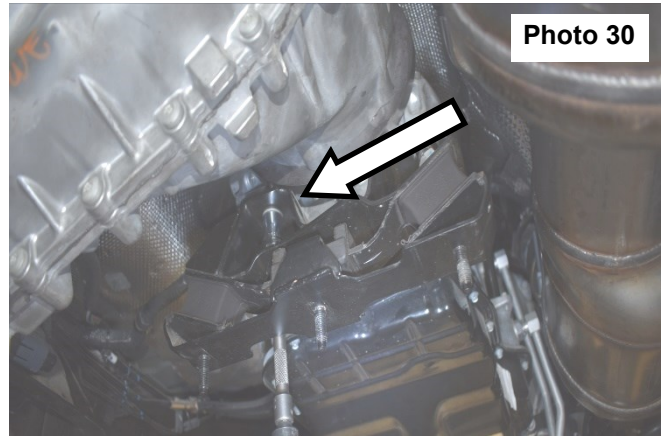
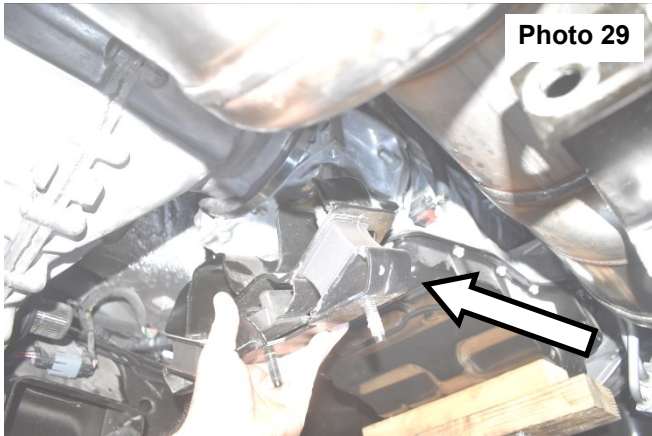

See Photos 29 & 30.

41. Install the supplied transfer case crossmember using the supplied 14mm x 200mm bolts, washers, and nylock nuts

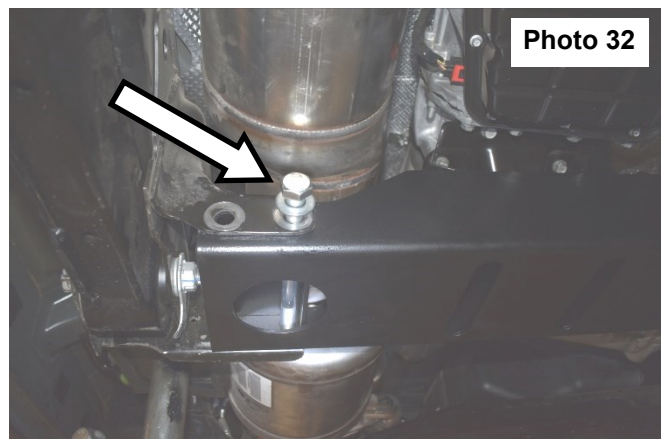
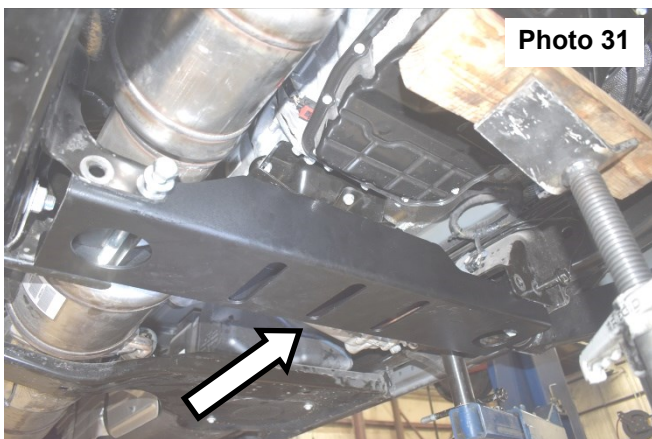

(36030BAG2) on the passenger side and the factory hardware on the driver side. See Photos 31 & 32.

42. Torque to 120ft/lbs using 24mm socket and wrench. See Photo 33.
43. Attach the crossmember to the crossmember mount using the factory hardware. Torque to 45ft/lbs using a 15mm

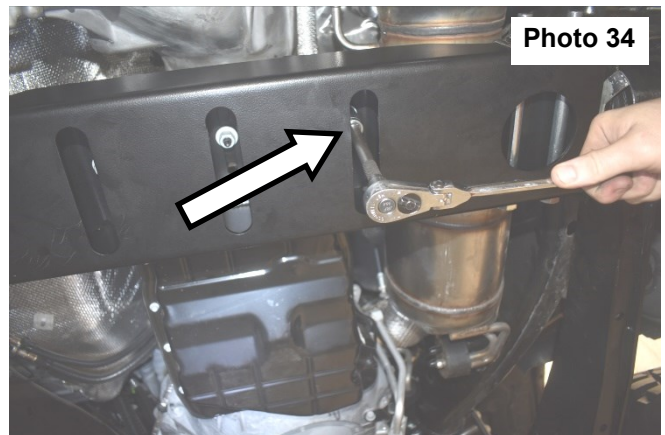
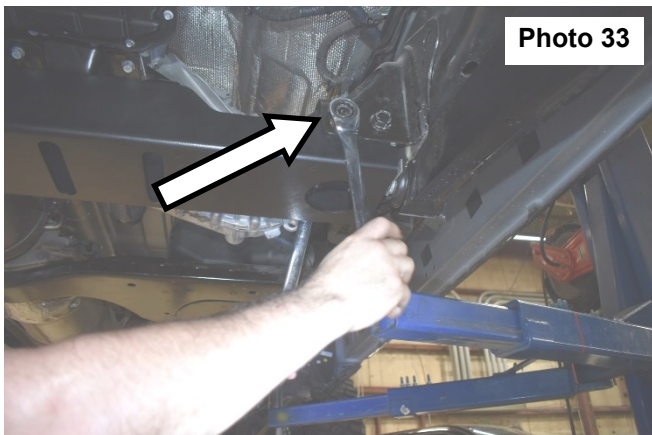

socket. **See Photo 34.**

44. Attach the supplied wire loom bracket to the transfer case using the supplied 1/4" x 1" bolt, washers, and nylock nut (36030BAG2). Torque to 10ft/lbs using a 7/16" socket and wrench. **See Photo 35.**

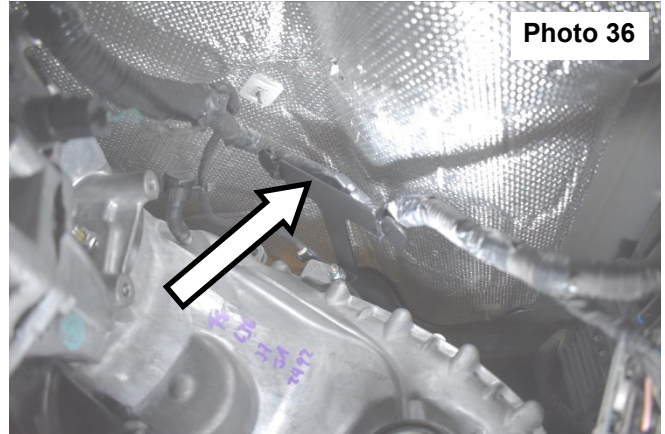
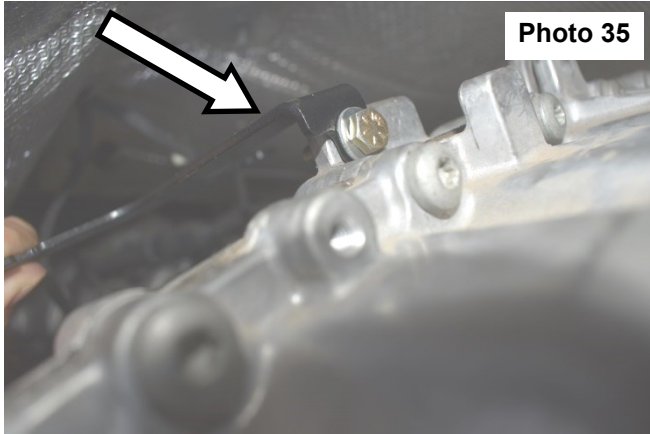

45. Attach the transfer case wiring harness to the wire loom bracket using the supplied cable ties. **See Photo 36.**
46. Install the front driveshaft on the transfer case.
47. Using snap ring pliers, slide the snap ring to the rear locking it into position. **See Photo 37.**

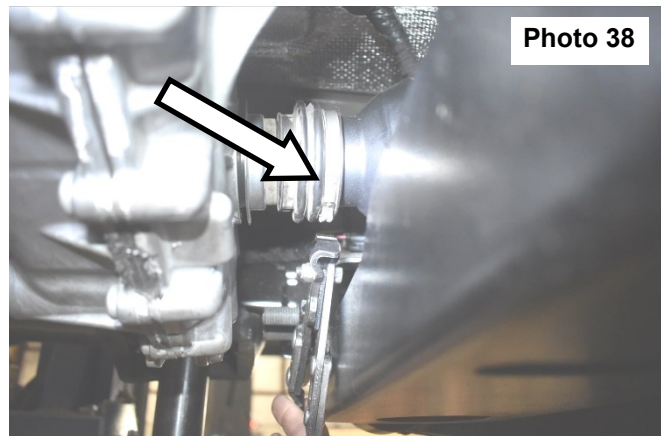
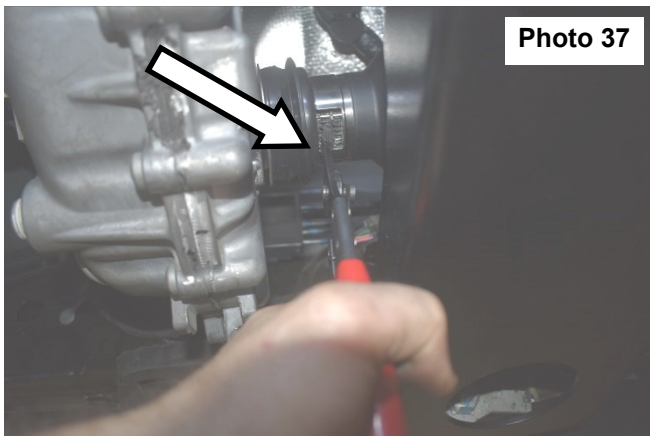

48. Roll the boot towards the front of the truck and install the front clamp. **See Photo 38.**
49. Attach the front driveshaft to the pinion flange using the factory hardware. Torque to 45ft/lbs using a 15mm socket.
50. Install the rear driveshaft using the factory hardware. Torque the rear pinion flange bolts to 45ft/lbs using a 15mm socket. **See Photo 39.**
51. Install the supplied transfer case skid plate using the supplied 3/8" x 1.25" bolts and washers (36030BAG2) to the crossmember and the factory hardware to secure the skid plate to the fuel tank skid plate. Torque the factory hardware to 9ft/lbs using a 10mm socket. Torque the 3/8" hardware to 35ft/lbs using a 9/16" socket. **See Photo 40.**

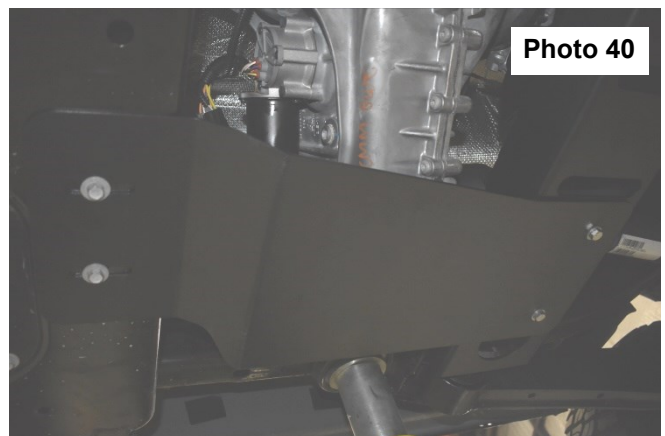

52. Jack up the vehicle and remove the jack stands.
53. Lower the vehicle to the floor.
54. Install the factory track bar to the new bracket with factory hardware. Torque to 130ft/lbs using a 21mm socket.
55. Install the supplied e-brake extension bracket as shown in **Photo 41**.

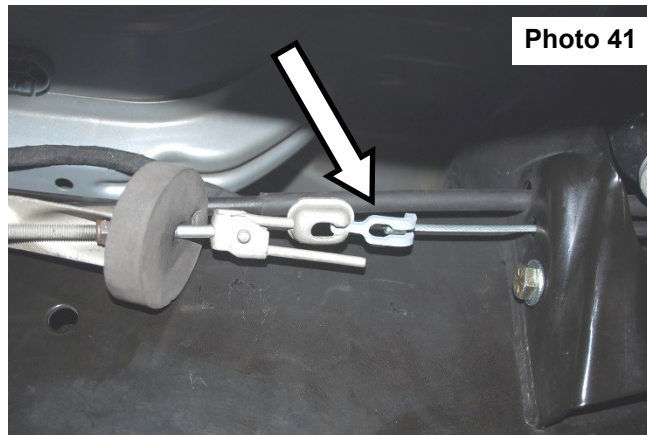

POST INSTALLATION INSTRUCTIONS

Check all fasteners for proper torque. Check to ensure there is adequate clearance between all rotating, mobile, fixed and heated members. Check steering gear for interference and proper working order. Test brake system. Perform steering sweep. Check to ensure brake hoses have sufficient slack and will not contact rotating, mobile, or fixed members, adjust lines/brackets to eliminate interference and maintain proper working order. Failure to perform inspections may result in component failure. Re-torque all fasteners after 500 miles. Visually inspect components and re-torque fasteners during routine vehicle service. Readjust headlights to proper settings. It is the buyer's responsibility to have all bolts/nuts checked for tightness after the first 100 miles and then every 1000 miles. Suspension components every 3000 miles.

Thank you for choosing Rough Country Suspension for your Off Road needs.

By purchasing any item sold by Rough Country, LLC, the buyer expressly warrants that he/she is in compliance with all applicable , State, and Local laws and regulations regarding the purchase, ownership, and use of the item. It shall be the buyers responsibility to comply with all Federal, State and Local laws governing the sales of any items listed, illustrated or sold. The buyer expressly agrees to indemnify and hold harmless Rough Country, LLC for all claims resulting directly or indirectly from the purchase, ownership, or use of the items.



E-Brake Bracket Drilling Template

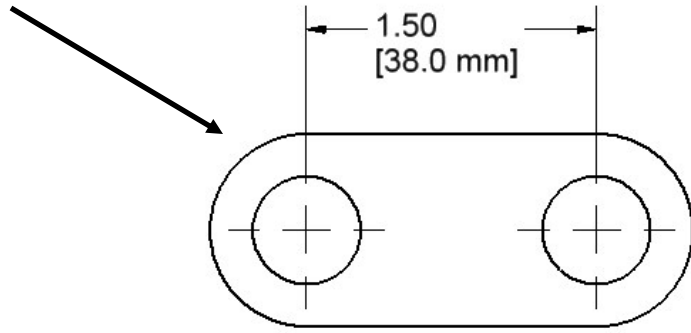

Pass Coil Spring Isolator Drilling Template

