

PAINLESS

PERFORMANCE PRODUCTS

**Wire Harness Installation
Instructions
Manual #90513**

For Installing: Part # 10150

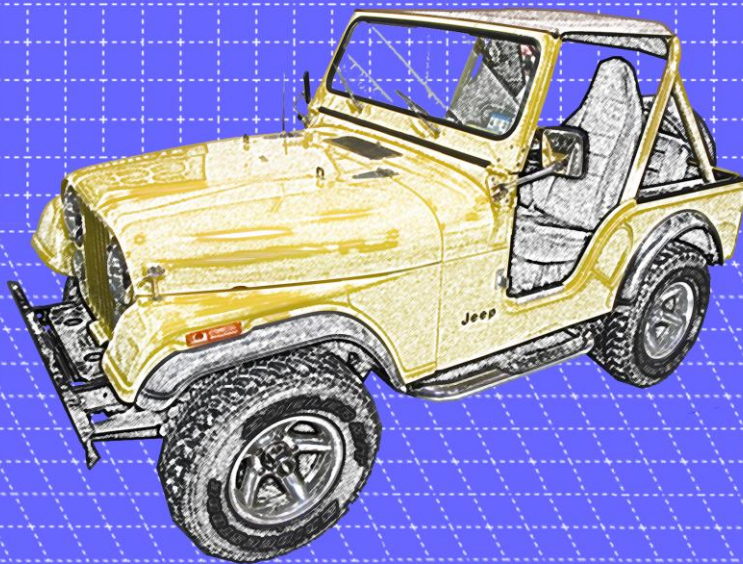

**CJ Jeep™ Harness
(1976-1986)**

Painless Performance Products recommends you, the installer, read this installation manual from front to back before installing this harness.

Painless Performance Products, LLC

2501 Ludelle Street

Fort Worth, TX 76105-1036

800-423-9696 phone – 817-244-4024 fax

Web Site: www.painlessperformance.com

E-Mail: painless@painlessperformance.com

If you have any questions concerning the installation of this product, feel free to call **Painless Performance Products'** tech line at 1-800-423-9696. Calls are answered from 8am to 5pm central time, Monday thru Thursday, 8am-4:30pm Friday, except holidays.

Here we have provided you with accurate instructions for the installation of this product. However, if you have comments/suggestions concerning these instructions, please call or email us (our contact information can be found at the top of this page or online at **www.painlessperformance.com**). We sincerely appreciate your business.

Painless Performance Products, LLC shall in no event be liable in contract or tort (including negligence) for special, indirect, incidental, or consequential damages, such as but not limited to, loss of property, or any other damages, costs or expenses which might be claimed as the result of the use or failure of the goods sold hereby, except only the cost of repair or replacement.

Should you damage or lose part of your manual, a full color copy of these instructions can be found online at www.painlessperformance.com

Installation Manual: **90513**

12th Edition: April, 2020

Copyright © 2014 by Painless Performance Products, LLC

CAUTION: BEFORE THE REMOVAL OF YOUR ORIGINAL HARNESS AND/OR THE INSTALL OF YOUR NEW PAINLESS HARNESS, DISCONNECT THE POWER FROM YOUR VEHICLE BY REMOVING THE NEGATIVE BATTERY CABLE FROM THE BATTERY. THE BATTERY IS NOT TO BE CONNECTED UNTIL THE PAINLESS HARNESS HAS BEEN COMPLETELY INSTALLED AND TESTED.

- If your vehicle has an existing harness, sheets of labels have been provided in the kit for you to identify/label connectors on your factory harness as you remove it from the vehicle. This will make it easier to identify various things at a later time. You will want to retain your factory harness for the possible re-use of various pigtails & connector housings particular to your application. It is best to avoid making any unnecessary cuts during the removal process.

Due to the wires being “hard wired” directly to the components, wires from the 1976-1982 wiper motor to the wiper switch and wires from 1976-1977 2 speed blower motors will be re-used.

Also if you have an existing transmission pigtail that connects to the backup/reverse switch, neutral safety switch, and 4wd switch, leave it connected to the transmission and simply unplug the original chassis harness from the inline connection at the firewall.

If you are using a factory Duraspark ignition system, retain the factory harness that connected the Duraspark module to the coil and distributor. This Painless chassis harness does NOT have Duraspark specific connectors; however there are clear instructions of how to reuse the original connections.

- This kit does not contain any of the computer controlled carburetor wiring. If you wish to retain this feature, you must reuse the factory wiring for this, however, this manual does NOT contain any instructions regarding the re-use of this wiring.
- Printed wires will have a 900-series number. These 900-series numbers are used to identify various wires and circuits in the wiring diagrams that are a part of these instructions. The 900-series number refers to the circuit and is not an individual wire number, meaning, the same 900-series number can/will be seen on numerous wires.
- In the event that there are unused or unconnected wires, the ends of all wires labeled in this instruction manual as “POWER” or wires printed with “B+” in the description, will need to have the ends terminated with an insulated terminal or taped. Doing so will prevent the wires from possibly shorting out and causing harness failure.

TABLE OF CONTENTS (CONTINUED)

<u>PAGE #</u>	<u>SECTION</u>
92	Under Hood Light
93	Neutral Safety Switch/Clutch Switch (Manual Transmissions)
96	Coil/Ignition Section
96	Coil Power
98	Tachometer
99	Ignition Module Bag
104	Engine Section
104	Coolant Temp
105	Oil Pressure
105	Electric Choke
106	Manifold Heater Relay
108	A/C Compressor
108	Alternator
110	Delco "SI" Alternator
111	CS-130, CS-121, CS-144 Series Alternator
113	CS-130D Alternator
115	Externally Regulated Motorcraft/Ford Alternator
117	Blower Motor
118	MIDI Fuse
120	Starter Solenoid
120	Factory Remote Starter Solenoid Mounting
122	SR 14 Relay
122	Ballast Bypass
125	Acc/Relay Activation
126	TAIL HARNESS INSTALLATION
127	Driver Side Park Light
128	Left Tail Light
130	Routing
131	Trailer
133	Fuel Level Sending Unit
134	Right Tail Light
135	Passenger Side Park Light
137	TESTING THE SYSTEM
138	WIRE INDEX

Schematics

<u>PAGE #</u>	<u>SECTION</u>
11	GOOD GROUND SOURCE
12	BAD GROUND SOURCE
13	ENGINE HARNESS GROUNDS
14	INTERIOR HARNESS GROUNDS
21	FUSE IDENTIFICATION
32	IGNITION SWITCH SCHEMATIC
33	TURN SIGNAL SWITCH SCHEMATIC
43	HEADLIGHT SWITCH SCHEMATIC
44	PANEL LIGHT SCHEMATIC
46	AFTERMARKET CLOCK
49	1983-1986 WIPER SWITCH
51	3 SPEED BLOWER SCHEMATIC
52	2 SPEED BLOWER SCHEMATIC-with factory wires
53	2 SPEED BLOWER SCHEMATIC-without factory wires
57	GAUGE CLUSTER CONNECTIONS
61	CLUSTER POWER SCHEMATIC
62	CLUSTER SCHEMATIC
64	POWERING AFTERMARKET GAUGES SCHEMATIC
65	GROUNDING AFTERMARKET GAUGES
66	AFTERMARKET GAUGE LIGHT POWER
67	AFTERMARKET GAUGE SENDER WIRES
69	AFTERMARKET TACHOMETER
70	FACTORY 4 CYL TACHOMETER
71	FACTORY 6 & 8 CYL TACHOMETER
75	ACC POWER OPTION #1- INTERIOR COMPONENT
76	ACC POWER OPTION #2- ENGINE BAY COMPONENT
77	12V RELAY ACTIVATION
78	GROUND RELAY ACTIVATION
79	ACC POWER OPTION #3- ENGINE BAY RELAY ACTIVATION
79	ACC POWER OPTION #4- INTERIOR RELAY ACTIVATION
80	ACC POWER OPTION #5- TOGGLE/ROCKER SWITCH RELAY ACTIVATION
95	REVERSE SWITCH PIGTAILS
101	POINTS IGNITION CONNECTIONS
101	PRESTOLITE BID IGNITION CONNECTIONS
102	DURASPARK CONNECTIONS
102	HEI (COIL ON CAP) CONNECTIONS
103	1980-1983 4 CYL HEI IGNITION
103	MSD IGNITION CONNECTIONS
107	MANIFOLD HEATER RELAY
111	10-SI ALTERNATOR
112	CS-130 ALTERNATOR
114	CS-130D ALTERNATOR
116	MOTORCRAFT ALTERNATOR
119	MIDI FUSE & BATTERY POWER SCHEMATIC
123	FACTORY "FORD" STARTER SOLENOID
123	GM STARTER SOLENOID CONNECTIONS
124	SR 14 STARTER RELAY
132	TRAILER SCHEMATIC
136	TAIL HARNESS SCHEMATIC

INTRODUCTION

Thank you for your purchase of a Painless Performance product. These instructions along with the Painless harness have been designed to allow you, the installer, the cleanest and easiest install possible.

During the course of reading this manual you will notice wire colors with a slash, as an example Black/White. This indicates a wire with a stripe. The first color is the main color of the wire and the color after the slash is the stripe color. In the case of the example, Black/White indicates a black wire with a white stripe.

Do not let the length of this instruction manual intimidate you. Much of the information contained in this manual is helpful information about each wire, where the wire comes from, where it goes, why a component needs it, etc. In many cases, there are multiple schematics as well as alternate connection options for the same wire/connection point. You will find that the actual install portions of this manual are pretty straight forward and easy to follow.

● The install portions are noted with a round bullet note, as seen here.

Individual components and sections are labeled with printed tags for easy identification. **As this harness is based on factory Jeep harness, conventional GM color code was followed.** These colors, along with the schematic diagrams found throughout this manual and the printed circuit numbers and description printed on the wire, will help you identify the different circuits during installation and later on if additions to the harness are necessary.

As you read through the installation manual prior to actual installation, blank areas titled **NOTES** have been provided to allow you to plan for and record information about connections to components Painless may or may not have pre-terminated. Use the **NOTES** to: **1** list component you are connecting to on your vehicle along with the pins/terminals or wires coming from it, **2** then list each function or power requirement, **3** last, use the text in the manual and the wire index in the back of the manual to identify the wire and circuit number in the Painless harness that will connect to that requirement. For example, connecting aftermarket tail lights with 3 wires to the wires found in the tail portion of this Painless harness.

NOTES		
1 <u>Aftermarket Tail Lights</u>	2 <u>Function</u>	3 <u>Painless Harness</u>
RED wire	Turn/Brake	#948 Lt. Green wire
White wire	Reverse Light	#949 Lt. Grn/Blk wire
Brown wire	Tail Light	#956 White/Black wire
		#929 White wire

PASSENGER SIDE
DRIVER SIDE

Planning connections beforehand will give you a better understanding of what needs to be routed, if any additional wires may need to be added, and how to make the best use of any extra circuits provided in the Painless harness. So, as previously stated, reading this manual before and installation of this Painless harness, as well as using the **Notes** sections will allow you to accommodate any connections that may or may not be supported with the new Painless harness before any physical routing or connection is done.

TOOLS NEEDED

In addition to your regular hand tools, you will need at least, the following tools:

● **Wire Crimping and Stripping Tools:**

This style of hand crimper can be purchased from just about any local auto parts store, home improvement store or can also be purchased online. You will need this style of crimper to crimp the heat shrinkable and non-heat shrinkable insulated terminals included in the small parts kit.

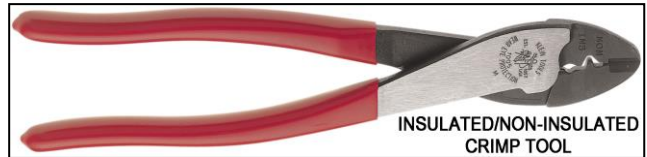

Another style of crimpers is “Jaw Crimpers” or “Roll Over Crimpers”. These crimpers will crimp factory style, un-insulated terminals. If none can be found locally, these crimpers can be found using Painless part # 70900.



A good set of wire strippers are required to strip wire properly. This style of wire stripper is ideal for this harness install because of its ability to properly strip wire gauges 10 to 20. These are available from just about any local auto part store, electrical supply shop, home improvement store or can be purchased online.

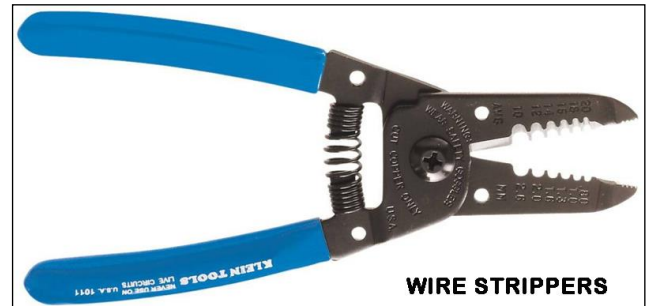

● **Volt/Ohm Meter:**

A Volt/Ohm meter is always a good tool to have on hand when installing any type of electrical components into any vehicle. Most basic units provide the two functions required to diagnose electrical issues seen during a harness install. These two functions are the ability to read DC Voltage and measure electrical continuity. They can be purchased from any home improvement store, local hardware store, auto parts retailers, or online.



● Electric Drill & Bits:

A drill and bits are needed in order to use the screws provided with the kit for the MIDI fuse holder and the fuse block mounting. The self tapping screws will require a ¼ nut driver.

● Heat Gun:

Very useful to shrink the heat shrink and heat-shrinkable terminals found in the parts kit.

➤ Small (10 amp or less) Battery Charger

See **TESTING THE SYSTEM** located on page 137.

➤ Factory Wire Schematic

This isn't absolutely necessary; however, having one handy is good practice with any electrical job. Manuals found at local auto parts stores generally have electrical diagrams.



PRE-INSTALLATION GUIDELINES

The best pre-installation practice is to become familiar with the harness by locating each of the harness sections. A good way to do this is by laying out the wire harness on the floor and identifying each of the section labels found on the harness as you read through this manual. The wire index in the back of this manual will help to quickly identify each wire in these sections.



As you go over the new harness and reading the instruction manual, remember to use the **Notes** sections to record solutions for any connections that do not currently have connectors pre-installed or for connections with connectors pre-installed that may need to be modified to fit your particular application.

While going over the harness with it on the floor, now would also be a good time to add any additional wires, like the ignition module wires or charge wire found in the kit, these two examples can also be easily added once the wires are routed in the engine compartment. Wires that may not be needed based on your application may also be removed from this harness during this harness evaluation and familiarization process.

After reading this manual and becoming familiar with the Painless harness, removal of the original harness can take place. Remember to use the supplied labels to identify each connection as it is removed in case future identification is needed. **Make sure the battery is disconnected before any connection of the factory harness is unplugged.**

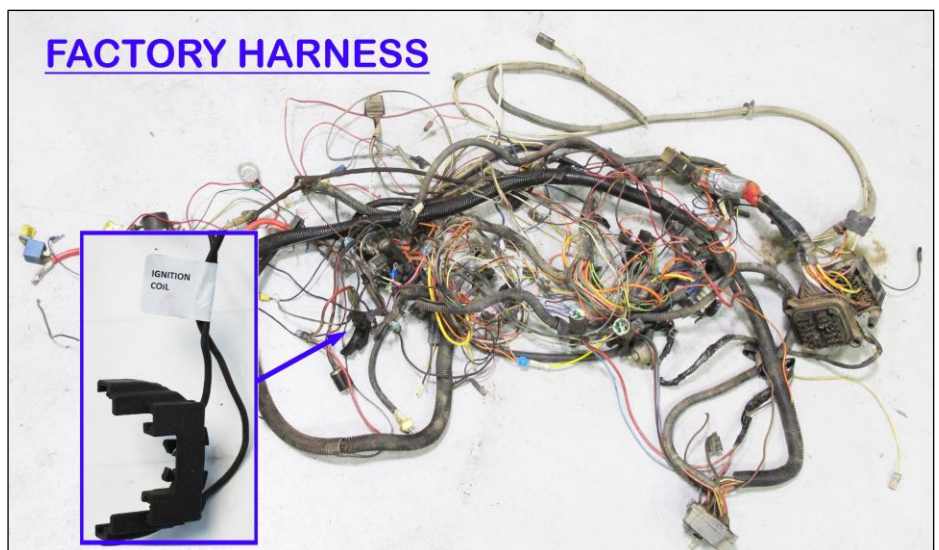

If possible remove the steering wheel, column trim on the dash and the bolts holding the dash in place. Doing so will allow you to pull the dash away from the body to reach behind it, making it easier to access the factory harness as well as route and install the new Painless harness. Be sure to carefully bag and label any bolts, screws, and/or nuts removed as it could be several days/weeks until you are ready to put it all back together.

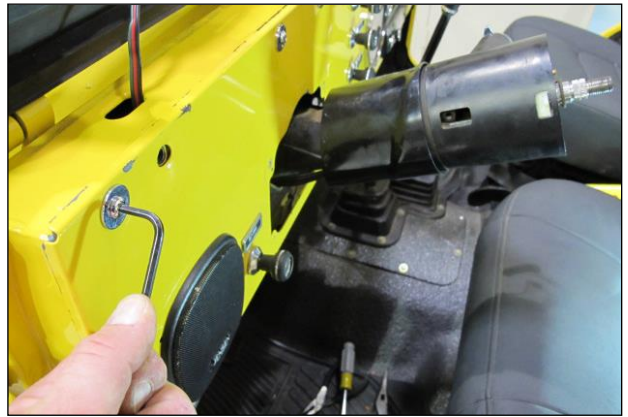

Please note that the heater control cables going to the control knobs to the right of the column will have to be disconnected before the dash can be pulled away from the body.

The steering column can be used as a support for the dash when it is pulled away. Before doing so, wrap a rag or an old t-shirt around the column, in the area indicated by the red arrow, and wrap it with tape or secure it using some of the larger zip ties provided in the kit. This will prevent the dash from scratching the column and/or the dash from sliding down the column.



Grounds

Throughout this instruction manual and when looking at the Painless harness you will see the word GROUND, maybe you've seen the ground symbol, seen to the right, on wire diagrams? What exactly is a ground and why do you need it?

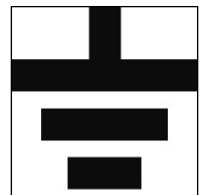

You've probably noticed the large cable coming from the negative side of your battery going down to the frame or to the engine. This cable allows electrical current to get back to the battery through the metal of the frame and all the other metal pieces bolted to the frame. **It is also important to have ground cables going from the frame to the engine and from the frame to the body.** Painless offers part # **40140**, seen in the photo, to supply these proper grounds back to the battery. **Painless strongly urges the installer to use this kit, or one like it, to replace the main grounding straps of the Jeep.** A properly wired Jeep will **NOT** function properly without clean, solid grounds.



A ground is simply the common path electrical current takes back to the battery. A ground, or chassis ground as it is often called, is any bare metal surface found on the vehicle which is connected back to the frame/negative side of the battery through mounting points and ground straps. These grounding points are needed in order for the electrical current to have a path to flow back to the battery.

There are two ways components are grounded in vehicles: through mounting and through wire connection. Some grounds are supplied through the mounting of the metal housings in which bulbs are installed, like turn signal or tail light housings. Components with plastic housings or non-conductive housings, like headlights which are glass, get their grounds through wires from the chassis harness.

To help avoid grounding problems, all the ground wires in this Painless harness are connected together through a series of splices. All of these splices in turn connect directly to the negative side of the battery, creating a completely integrated ground system that will help those with fiberglass bodies, see the [Ground Schematics](#) on pages 13 and 14.

On light housings that ground through their mounting and for the harness ground wire connection points, make sure that all mounting points are clean by removing all dirt, corrosion, or paint. This is especially important for Jeeps that have recently been painted, as paint build up will create grounding issues. 80-150 grit sandpaper should be all that's needed to properly clean grounding points.

Why are clean grounds important?

As an example we will use a front turn signal that also functions as a park light. Follow the red line from right to left in the diagrams below and on the next page. This red line indicates the path electrical current takes when everything is properly grounded and as represented in the second diagram, when the ground is bad; notice which bulbs illuminate when good and bad grounds are present.

In our park light example with a good ground source, current travels from the headlight switch to the park light bulb. Since the bulb is properly grounded, current passes cleanly through the bulb causing it to illuminate and the current exits the bulb through the ground source back to the battery. The ground allows everything to work properly without any issues.

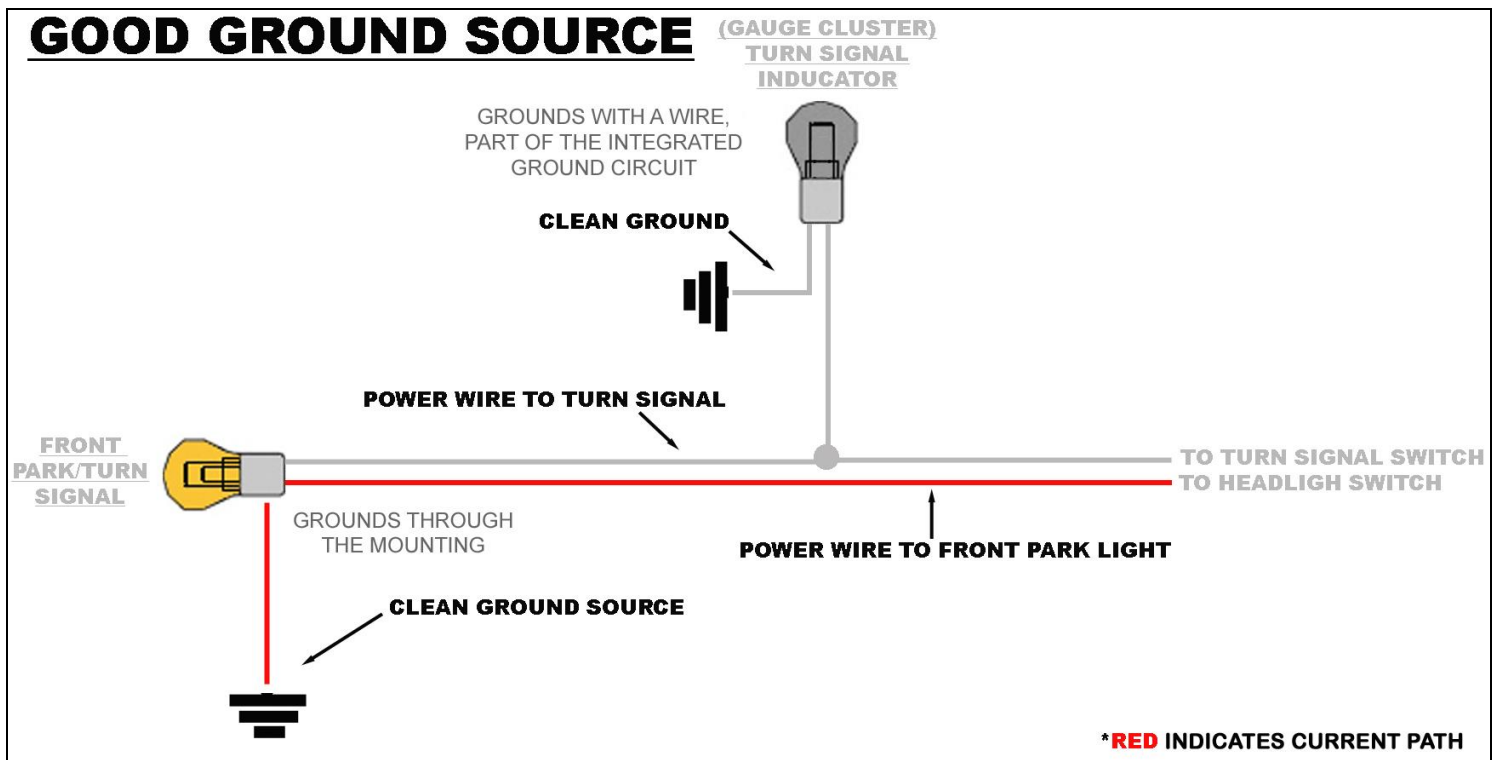

When a ground isn't connected or is contaminated with dirt, corrosion, or paint, the CURRENT will find the easiest path to ground, which is represented in the diagram below.

Current travels from the headlight switch to the park light bulb, but wait; there is no ground at the bulb.

Since the ground it would normally use is not there, the current will find another way to get to ground and back to the battery. When this happens, things that should not have power receive power coming from the park light bulb.

Since the turn signal wire also goes to the bulb, the current will travel through the bulb using the turn signal wire. Notice in the diagram that a bad ground at the front park light can cause issues on the interior of the vehicle at the turn signal indicator on the dash. In this case, the turn signal indicator light is illuminated when it shouldn't be. Also, since this one power source which was only supposed to power 1 bulb is now powering 2 bulbs, both bulbs may be dimmer than they would have been if everything was grounded properly. This is one of the problems with diagnosing a bad ground; they can cause issues throughout the entire vehicle.

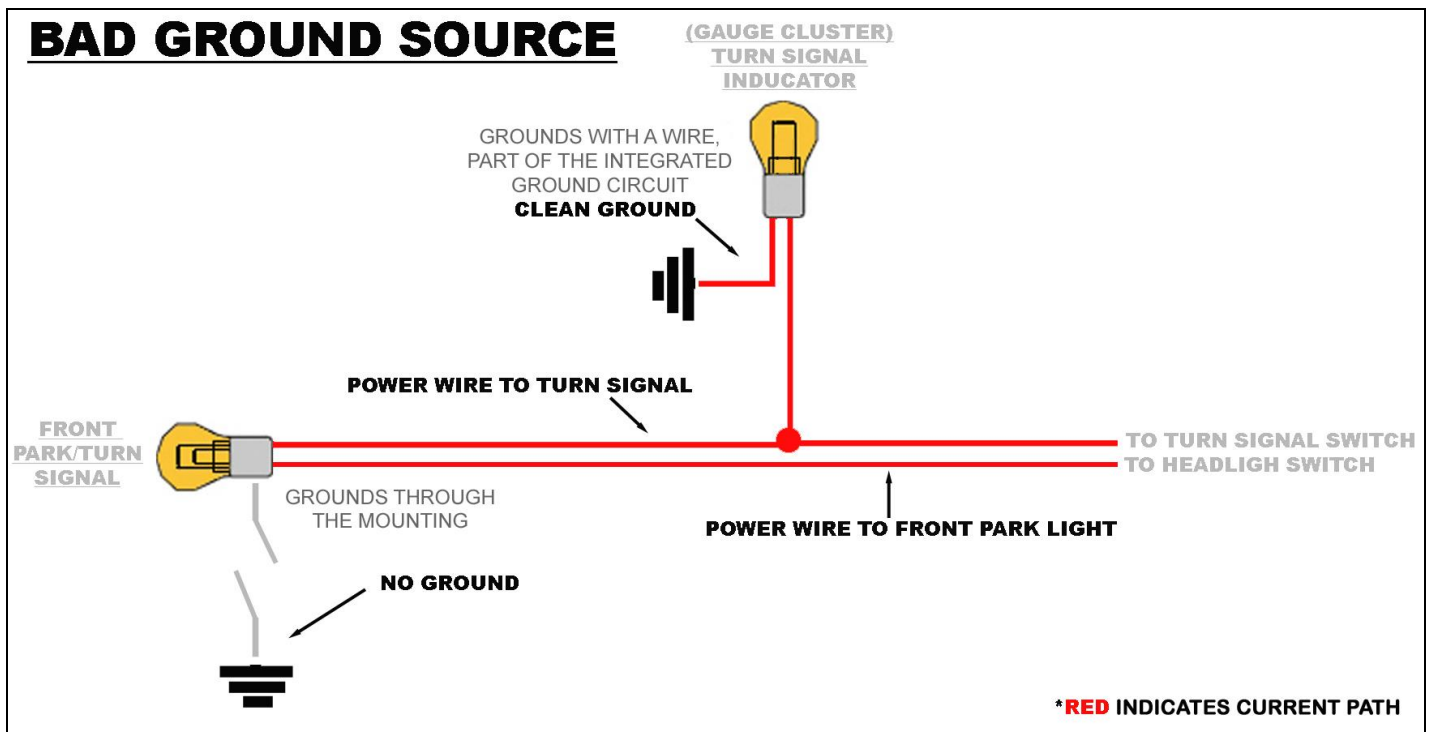

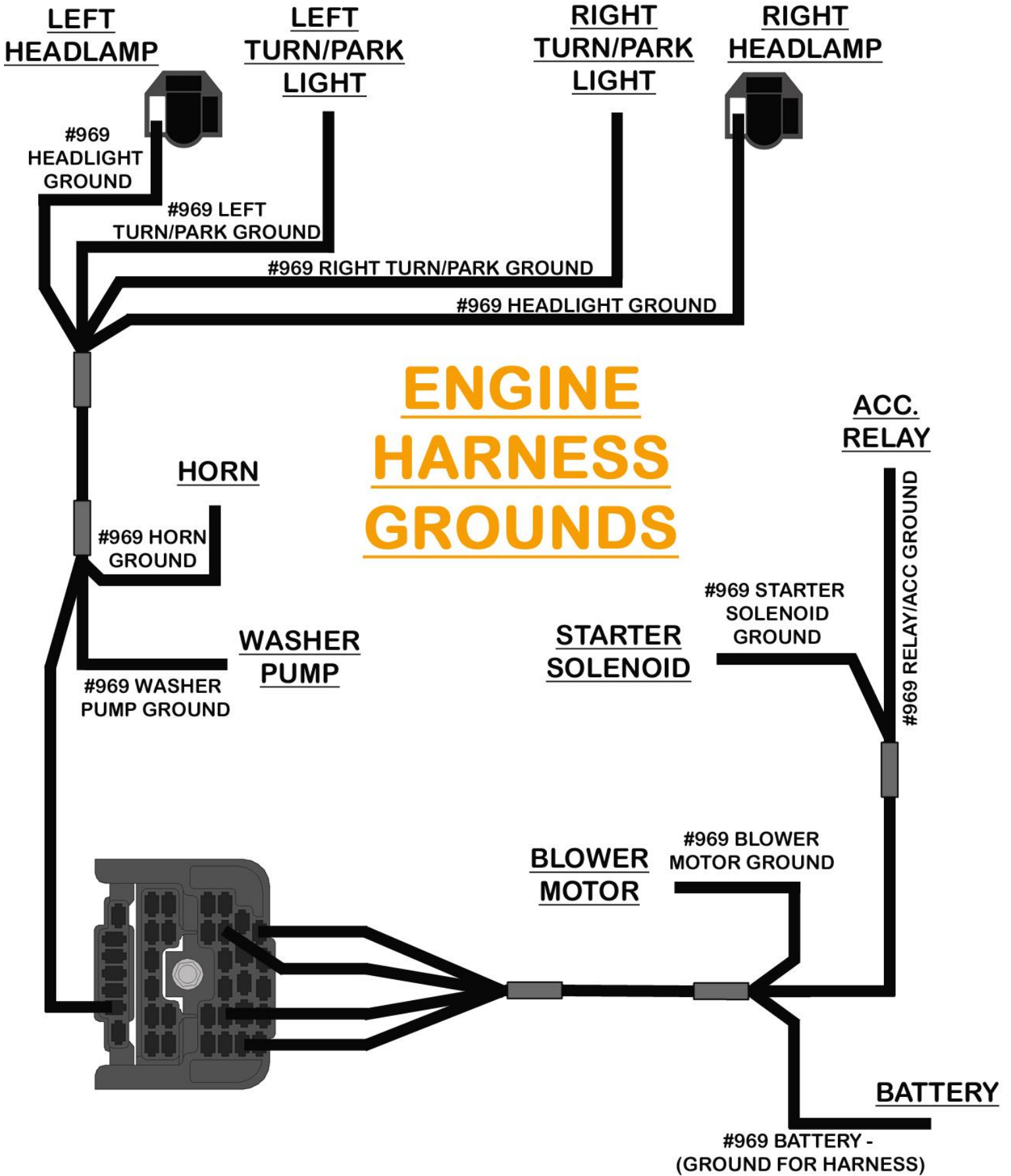

INTERIOR HARNESSES GROUNDS

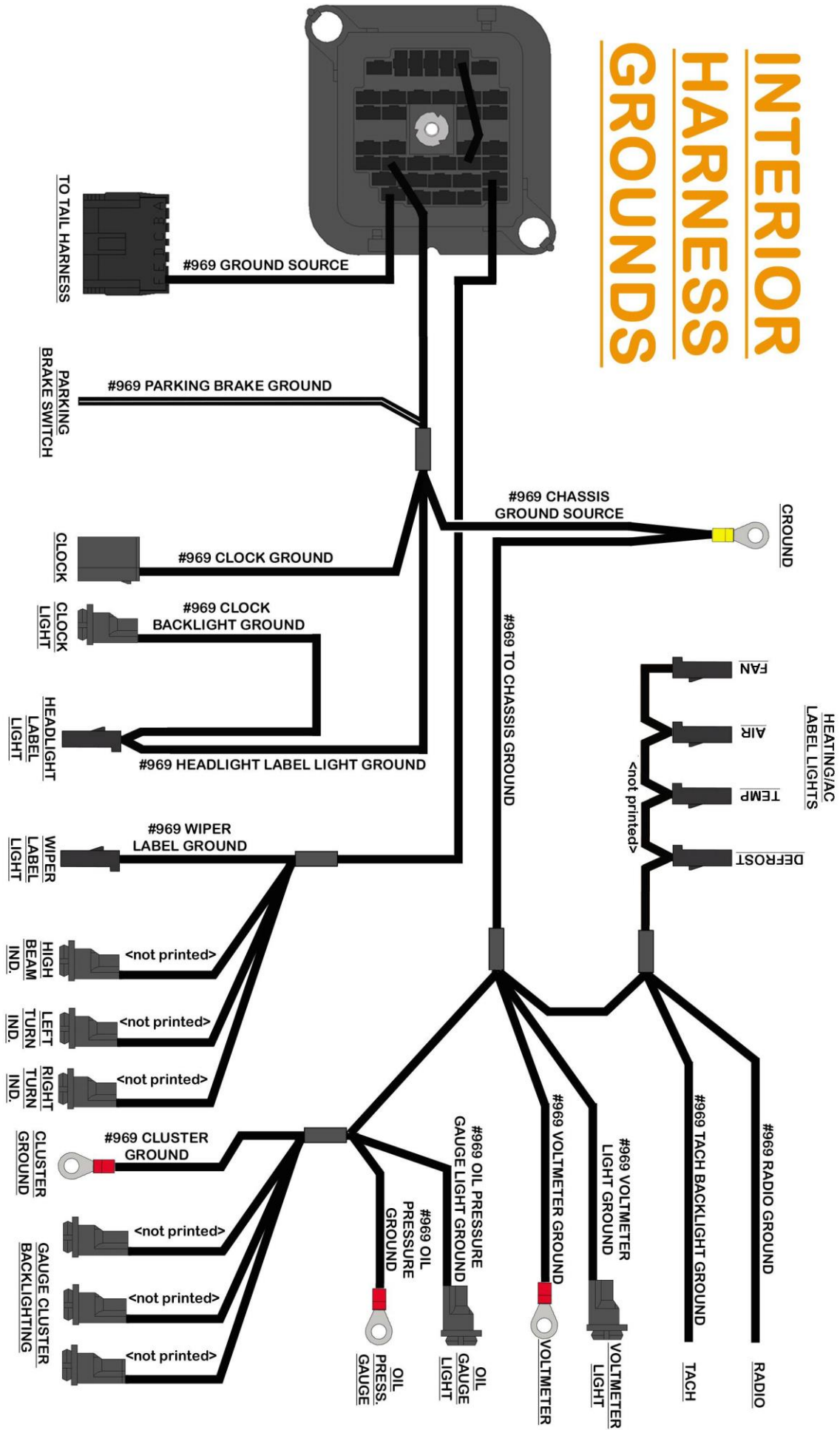

CONTENTS OF THE PAINLESS 10150 KIT

Refer to this photo to take inventory. See that you have everything you're intended to have in this kit. If you find that anything is missing or damaged, please contact the dealer where you purchased the kit or Painless Performance at (800) 423-9696.

The Painless 10150 Harness Kit should contain the following:

- This manual
- 2 Parts Kits: (1) insulated/heat shrinkable terminal kit & (1) un-insulated terminal/connector kit
- 3 bag kits and grease: (1) Alternator bag, (1) bag w/ zip ties, connectors, and light bulbs, (1) bag of wires labeled : "IGNITION MODULE"
- Large gauge red charge wire
- Interior/Dash Harness, with the fuse block pre-installed
- Engine/Headlight Harness, with bulkhead pre-installed
- Tail Harness



SMALL PARTS

Included with the Painless harness is a parts kit containing miscellaneous terminals, fuses, screws, and nuts. Splices and ring terminals have been provided as many different components and configurations of aftermarket parts require additional power sources and grounds to be added to properly wire these components.

When crimping these insulated splices and ring terminals, take notice of the seam/split in the terminal. Make sure the smooth side of the jaw on the crimper goes towards this seam/split. The terminals below are not insulated to better show the seam. AS you can see, the crimpers shown in the photo has both non and insulated crimping jaws. If your crimpers and a notch labeled "INS", meaning insulated, use this notch instead of the male female notch shown in the photo.



Installing "56 Series" Terminals

In the parts kit you will see different non-insulated male and female terminals. These terminals are for factory style connections and require roll over crimpers, see page 8.

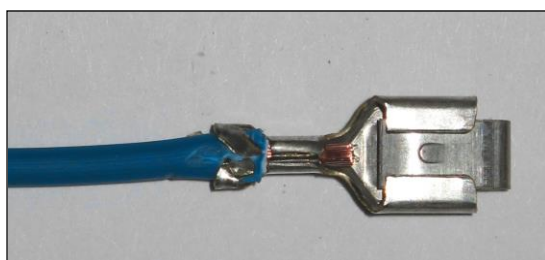
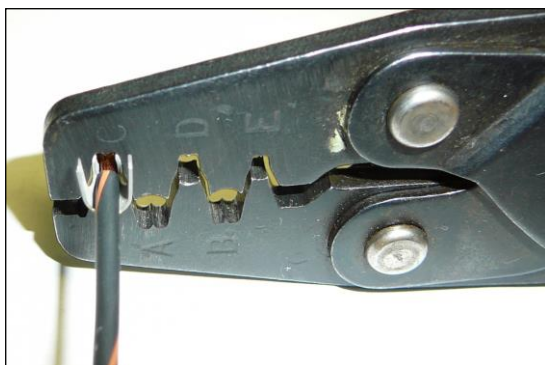
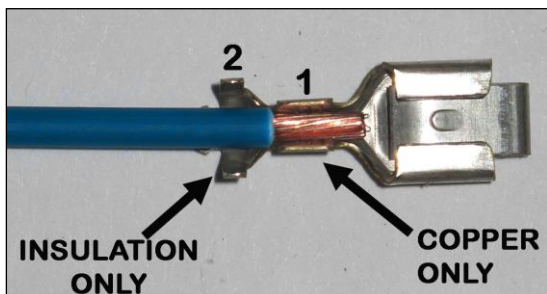

- Strip about ¼" of insulation off of the wire.
- Insert the wire into the terminal. There are two terminal straps on the terminal. For instructional purposes, we will label them 1 and 2. Strap 1 crimps the exposed copper strands of the wire, while strap 2 crimps the wire insulation. Make sure your strip length is long enough to ensure only copper strands are crimped by Strap 1, but make sure it is short enough that only insulation is crimped by Strap 2. The photo to the left best demonstrates this.
- Using the appropriate jaw on the crimpers, crimp Strap 1. The appropriate jaw depends on the wire gauge as well as the terminal stiffness. If you are unsure which jaw to use, you can always

start with the biggest and work your way down until you get a tight crimp.

- With Strap 1 crimped you can move onto crimping the insulation strap, Strap 2. Place Strap 2 into the appropriate jaw of the crimpers. This jaw will be larger than the one used to crimp the first strap. Crimp down on Strap 2 making sure the strap folds downward into the wire, and not overlapping itself, refer to the drawing below. Overlapping could cause problems with the terminal fitting into the factory connector.

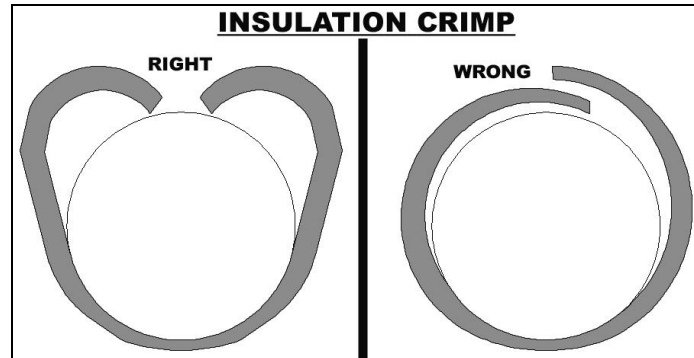

Installing “Weather-Pac” Terminals with seals

In the parts kit you will see different non-insulated male and female pin and socket terminals along with silicone seals; the seals in the kit will be a different color than the one shown. These terminals are for tail light connections and require roll over crimpers, these may or may not be used on your particular install.

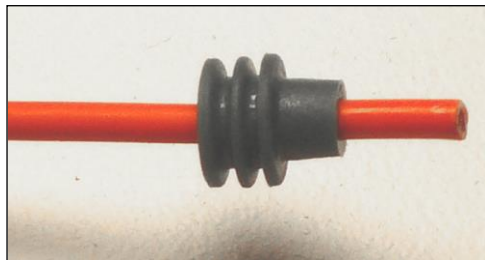

- Seal Installation:

Slide a seal over the un-stripped wire as shown in the photo to the left. Doing this over an un-stripped wire will prevent the copper strands of exposed wire from penetrating the inside of the seal making it difficult to slide the seal onto the wire insulation.

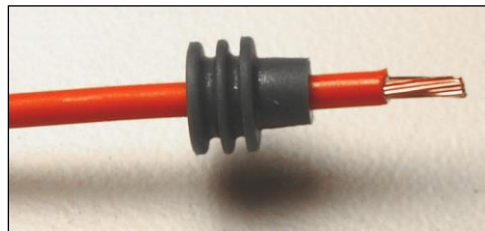

- Strip Wire:

With the wire seal in place, strip no more than ¼” of insulation off of the wire. If your strip length is too long, then the terminal will not fit the wire properly and may not crimp the wire seal when crimping is done. Once you have stripped the wire, slide the seal towards the bare wire.

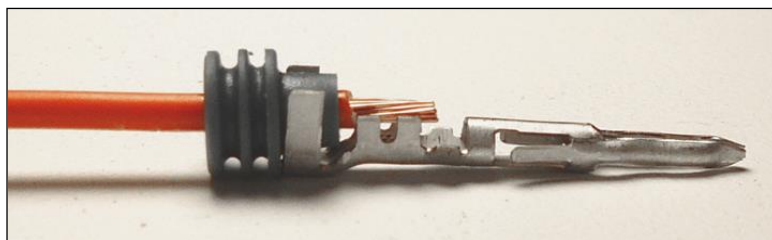

- Terminal Installation:

Install the terminal onto the wire as shown in the photo to the left. The tall straps found on the rear of the terminal will cradle the small end of the wire seal. The small straps found in the middle of the terminals should cradle the exposed copper of the stripped wire. If things do not fit as shown, you may have too much exposed copper wire or not enough. You will need to adjust your strip length until your terminal, seal, and wire strip resemble those pictured. Failure to do so will result in a bad crimp.

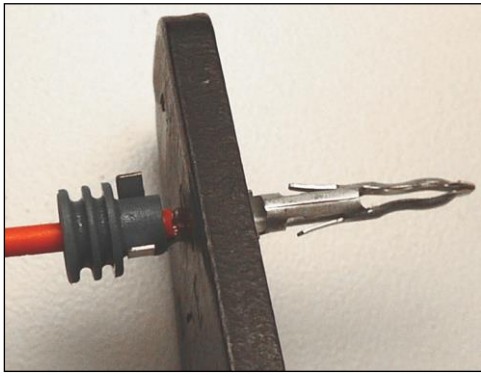

● Wire Crimp:

With the proper terminal, wire, and seal alignment established, you can now crimp the terminal to the exposed copper strands. Using the appropriate jaw location on the crimpers for the gauge wire you are using, crimp the terminal onto the wire. Make sure the crimp causes the terminal to “roll” over and down into the copper wire. In some instances, usually when the wrong jaw size is used, a crimp will cause the terminal straps to fold over on top of each other, as shown at the top of p. 17, this is not a good crimp. The right crimp is illustrated below. **Avoid over crimping which causes the terminal to distort and will make it difficult to plug into the connector.**

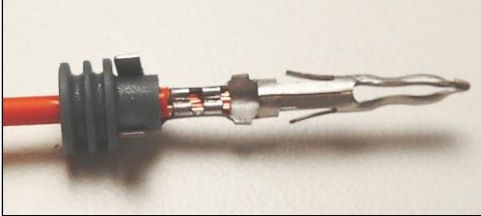

● Seal Crimp:

The Terminal/Seal crimp is done in the same manner as the Terminal/Wire crimp. In most cases, depending on your crimpers, this crimp will be done using the largest jaw location on the crimpers. This crimp is simply holding the soft silicone seal to the terminal so not a lot of crimp force is needed. Again, when crimping the seal, make sure you get a “roll” over crimp as shown in the illustration on p.17. Once the seal is crimped, you can now insert the wire and terminal into the correct pin location of the correct connector. **Avoid over crimping which causes the straps of the terminal to break off, resulting in the seal not being crimped into the terminal.**

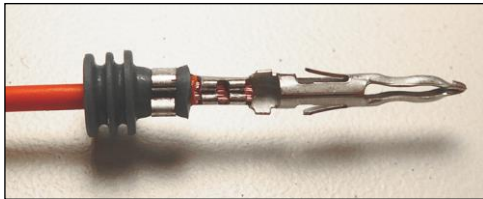
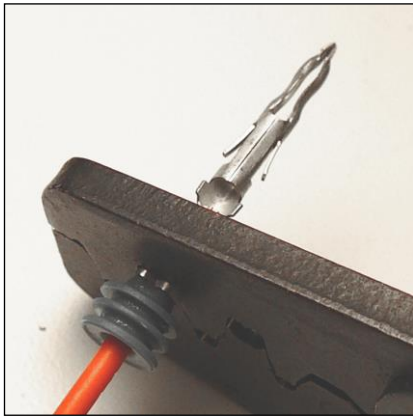

Bag Kits:

A large bag will contain a ballast resistor, see p.97, rubber grommets and zip ties. Harness mounts which allow zip ties to be attached have been provided for you to secure the Painless harness to the inner fender, core support, and/or frame. These mounts fit into 3/16” holes left behind by factory plastic retainer loops or those created with a drill by the installer.

When zip ties are installed as the harness is routed, wrap the tie around the harness and LOOSELY tie the harness. Make sure you leave enough room to pull and push the harness as you make your connections. Only when all connections have been made will you tighten the zip ties.



This bag will also contain four 4 pin Weather-Pac connectors (two male and two female), these are for aftermarket tail light connections. The use of these will depend on the tail lights your vehicle has, additional information can be found on p. 129



A molded 4 pin connector pigtail can also be found. This connector is to allow connection to the trailer connector found on the tail harness. This connector will help provide power for left and right turn/brake lights, tail lights, and ground to a trailer. This connector can also allow those who flat tow their Jeep a connection to provide power to the rear lighting of the Jeep. This connector and it's use is described in detail beginning on p. 131.

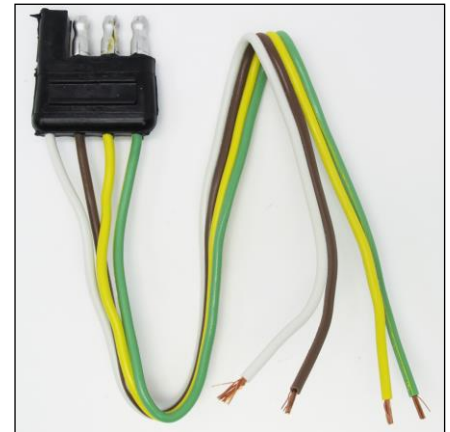

Light bulbs are also included in the bag kit. There are multiple types of bulbs provided: small bulbs for cluster illumination, turn signals etc., larger amber bulbs for front turn signals, and clear single and dual filament bulbs for reverse lights and brake/turn tail lights. Specifics, such as which bulbs to use for a particular socket, can be found throughout the manual when connections are being made. Dielectric grease has also been supplied, apply a small amount to the contacts of the bulbs before installing them into their sockets. Wedge style bulbs for the marker lights are pre-installed on the harness as the risk for breakage during shipping is not as great with these smaller bulbs as it is with the larger round bulbs.



In this same larger bag you will also find a small bag kit labeled "ALTERNATOR" which contains all of the components needed for alternator connections. In this "ALTERNATOR" bag you will also find hardware and components for an inline MIDI fuse installation. These parts include the base with cover, fuse, mounting screws and ring terminals. This fuse is to isolate the battery from the alternator in the event the regulator faults and tries to send excessive amperage to the battery.



HARNESSES



Locate the Engine/headlight harness; this will be the harness with a large rectangular bulkhead connector pre-installed. This harness will have connections for the headlights, horn, front turn signals and marker lights, as well as connections for components on the engine and for the start, charge, and ignition systems.

The engine, start, charge, and ignition systems are where most installs vary the most since there are numerous factory configurations and an infinite number of possibilities when you take into account engine swaps and aftermarket components. Take the time during this identification process to carefully determine what you are working with and use any other manufacturer's instructions for aftermarket components such as coils, ignition boxes, and alternators in conjunction with this Painless manual to figure out which wires from this Painless harness will connect to the components installed on your vehicle. You can record your findings in the **Notes** section for that particular connection.

The next harness is the interior harness; this will be the harness with the fuse block pre-installed. This harness also has a firewall bulkhead installed onto the back of the fuse block in which the engine harness will plug into after being mounted. This interior harness will have connections for the switches and gauges found on the dash, as well as a connection for the steering column. Use this opportunity during the identification process to determine what addition gauges may be installed, if an aftermarket head unit/radio is installed, how it will connect, etc.

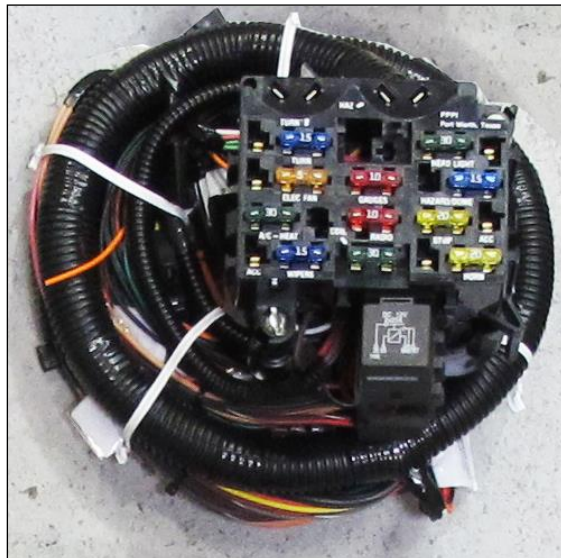

The final piece of the puzzle is the tail harness, this be the longest of the harnesses but has the fewest amount of wires and connections. This harness will provide power to the rear exterior lights and also send a signal from the fuel tank to the fuel gauge. This harness plugs into a connector found near the fuse block on the interior harness.

Fuse Block

The Painless harness comes pre-terminated with a fuse block that uses 11 modern ATC blade style fuses. This fuse block allows the convenience of having both flashers (turn signal and hazard), as well as the horn relay, to be mounted in one location.

Fuse Identification

The drawing below left shows all the battery power fuses, circled in red. These fuses are powered by wires that come from the large power splice in the engine/headlight harness, seen on page 119, through the bulkhead and to the fuse block. **All of these battery power fuses will have power at all times.**

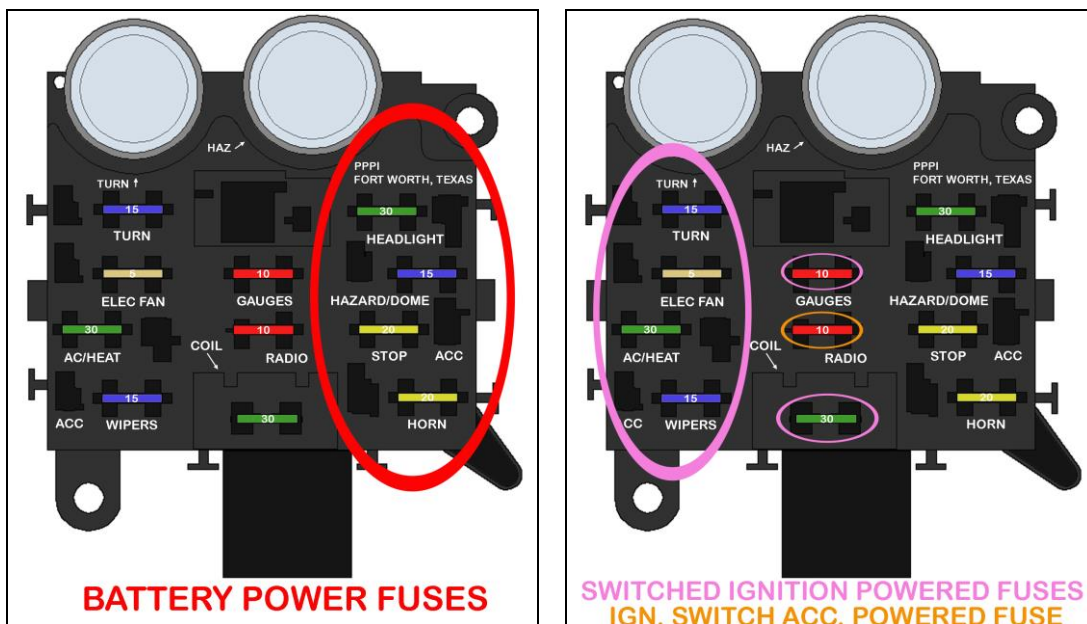

The drawing above right shows all the switched ignition fuses. These fuses are powered by wires coming from the ignition switch and will have power depending on the position of the ignition switch. **None of these fuses circled in pink or orange should have power when the ignition switch is in the OFF position.**

The fuses circled in pink will have power only when the ignition switch is in the "ON/RUN" position, with the exception of the COIL fuse as it will have power when the ignition switch is in the "ON/RUN" position and "START" position.

The Radio fuse, circled in orange, will have power when the ignition switch is in the "ACCESSORY" position and in the "ON/RUN" position.

Horn Relay

On the fuse block you will find a horn relay, which replaces the factory core support/firewall mounted horn relay found on older vehicles. The fuse block mounted horn relay uses a standard 30 amp SPST relay and is ground activated from a wire in the Turn Signal Switch group of wires of the dash harness. Replacement relays for the horn relay can be found at any auto parts store or by ordering [Painless part number #80131](#).

Flashers

The two flashers simply switch power off and on going to the turn signal switch and hazard switch. The flasher on the top left of the fuse block is the turn flasher, and the top right side is the hazard flasher, both flashers are also identified on the fuse block.

How a flasher functions is simple. Power is switched off and on according to heat built in the resistance wire inside the flasher. As soon as power is drawn through the flasher, as when the turn signal or hazard switch is activated, the resistance wire heats up and makes contact with the output side of the flasher. This contact passes power through the flasher, into the switch and to the turn signal lamp(s). Once this contact has been made, the resistance wire is no longer resisting any voltage, so it begins to cool; this cooling causes the flasher to lose contact.

This loss of contact means that there is no longer any voltage going to the switch, causing the turn signal light to turn off. Once contact is lost, the resistance wire begins heating up and the entire process starts over again until the turn signal switch or hazard switch is disengaged.

Some L.E.D. turn signals do not draw enough voltage to activate a typical thermal flasher. If you are using L.E.D. turn signals, and your turn signals do not work properly and you are certain everything is connected properly, a no load flasher will be required; Painless [part number #80230](#).



Installation

The installation of your wire harness mainly consists of two parts:

- The physical routing and securing of the wire harness, wires, and groups.
- The proper connection of the individual circuits.

These two major tasks are not separate steps, but are combined. That is, you will route some wires and make some connections, route more wires and make more connections. Harness routing will follow the same path as the factory harness.

To achieve these tasks, and as mentioned previously in the manual, fuse block mounting and the dash/interior harness installation will be easier if the steering wheel, column trim, and the bolts holding the dash in place are removed.

Remember to insulate any unused power wires. Insulating can be done by simply crimping an insulated terminal from the parts kit onto the end of the wire or by folding the wire 180° back onto itself and wrapping it in tape.

Fuse Block Mounting

To begin mounting the fuse block, you will need to enlarge the 2 factory mounting holes; these holes can be found next to the upper right and lower left of bulkhead opening. A 1/4" or 5/16" (either is acceptable) bit and an electric drill will be required for this modification. This drilling step may be skipped if you re-use the screws that were holding the factory fuse block.

- Using the drill bit, enlarge both firewall mounting holes. This will allow the 1/4" fuse block mounting bolts supplied with the Painless harness to pass through the firewall.

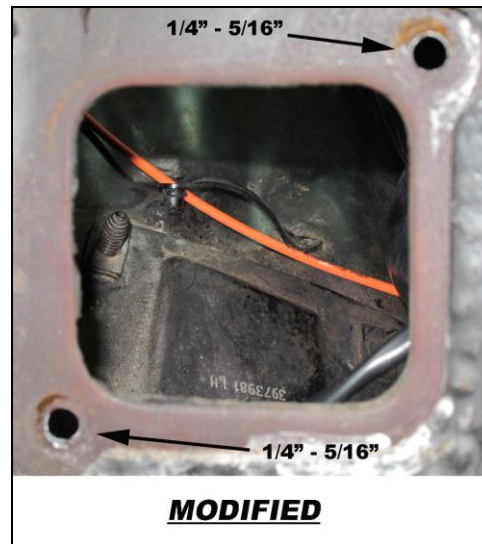
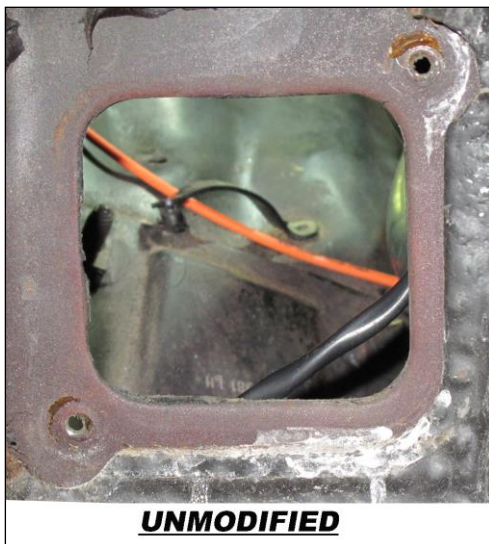

With the holes enlarged, the fuse block can now be mounted.

- Remove the 2 nuts and flat washers pre-installed on the fuse block.

Before being mounted, ensure you have the dimmer switch connection coming out of the bottom of the fuse block.

- From the inside of the Jeep, install the fuse block onto the firewall by inserting the bolts through the fuse block and then through the enlarged firewall mounting holes.

This next step will require a helper.

- On the engine side of the firewall, install the flat washers and nuts previously removed from the fuse block, this will require the use of a 7/16 socket or wrench. A helper with a flat head screw driver will be needed on the inside of the vehicle to keep the bolts from turning while the mounting nuts are tightened.



Dash Harness Routing

The following steps will be easier with the dash completely removed; however it is not completely necessary. If you have already removed the bolts and the steering wheel as instructed for the factory harness removal then this step should be as easy as pulling the dash off the column.

- Looking at the following photographs, route the harness above the column behind the steering column support, identified in the photos.

Connections for the Clock, Headlight Switch, and the Ground connection will NOT route over the column. These connections can be identified by the white section labels found on the harness.

This will be all of the routing done for this portion of the harness, the rest of the routing is done while making the various connections along the dash.

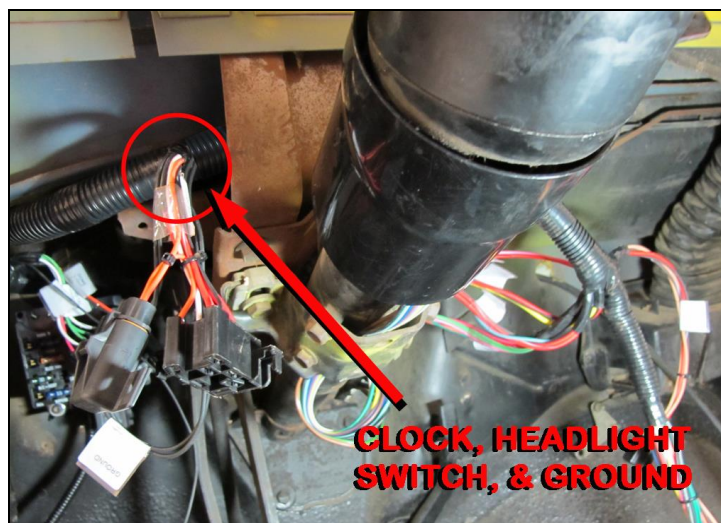
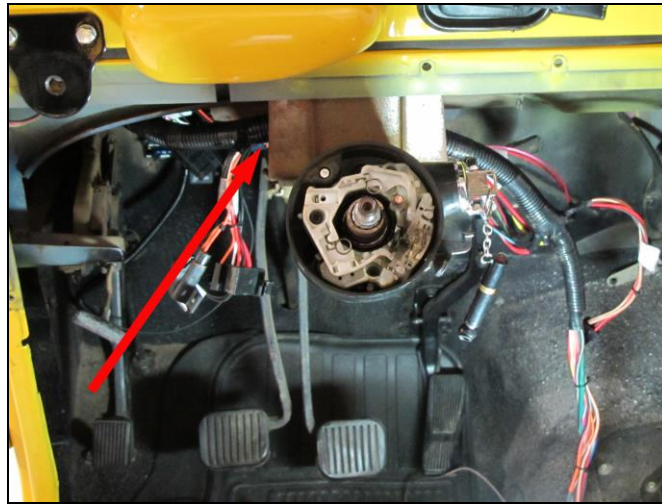

Before the dash is re-installed over the column, connections to the steering column (turn signal switch and Ignition switch), the brake switch, and the neutral safety switch (on vehicles with factory automatic transmissions) can be made with the dash removed.

“Ignition Switch”

The ignition switch is one of the most important connections of a wire harness. Its function will control power to the switched ignition fuses on the fuse block as well as sending a start signal to the starter to allow engine operation.

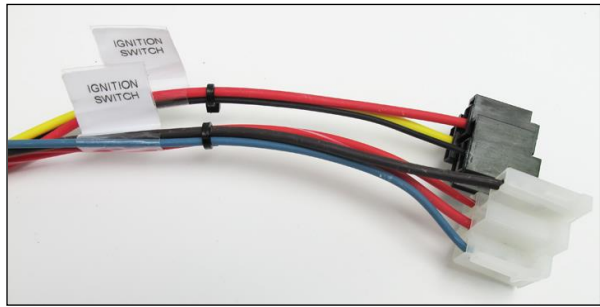

The ignition switch connection consists of two connectors with a section label reading “IGNITION SWITCH”. These two connectors will be black and clear. All wires going to the ignition switch connectors can be seen in the [Ignition Switch Schematic](#) on page 32.

The black connector is a four pin connector with the following wires:

Red: 12 gauge wire, printed **#934 IGNITION SWITCH POWER**, this wire comes from a buss bar on the fuse block and feeds battery power to the ignition switch. This wire will have power at all times.

Yellow: 12 gauge wire, printed **#933 SWITCHED (IGN) POWER TO FUSE BLOCK**, this wire provides the switched power source to the fuse block. This wire powers all of the ignition switched power circuits to the harness, with the exception of the RADIO and COIL fuses. This wire will only have power when the ignition switch is in the ON/RUN position.

Black: 18 gauge wire, printed **#968 KEY ON LOW BRAKE SIGNAL**. This will provide a ground source to the low brake light on the instrument cluster when the key in the start position. This will indicate that the bulb is operable and will indicate when a low brake fluid pressure condition occurs or if the emergency brake is still applied.

The clear connector is a five pin connector and will have one cavity that is empty, this is intentional and not an error during production of the harness. The following wires can be found in this connector:

Red/White: 14 gauge wire, un-printed but inches away is plugged into another red/white wire printed **#931 SWITCHED POWER TO "COIL" FUSE** (see page 32), these wires provide power from the ignition switch to the COIL fuse on the fuse block. This wire will have power when the ignition switch is in the ON/RUN position as well as the START position.

The inline connection found on the Red/White wire coming from the clear ignition switch connector is for those using a factory 6 or 8 cylinder tachometer. **Do one of the following:**

- If you are a factory 6 or 8 cylinder tachometer, disconnect these two wires. These connectors will now plug into the wires coming from a factory tach, this connection will be handled later in the manual on page 71.
- If you are using a factory 4 cylinder tach, an aftermarket tach, or no tach at all, leave the two red/white wires connected so power can be delivered to the “COIL” fuse

Light Blue: 12 gauge wire, printed **#919 IGNITION SWITCH "START"**, this wire will send power to the neutral safety/clutch switch to engage the starter solenoid. This wire will only have power when the ignition switch is in the START position.

Red: 12 gauge wire, printed **#934 IGNITION SWITCH POWER**, this wire comes from a buss bar on the fuse block and feeds power to the ignition switch. This wire will have power at all times.

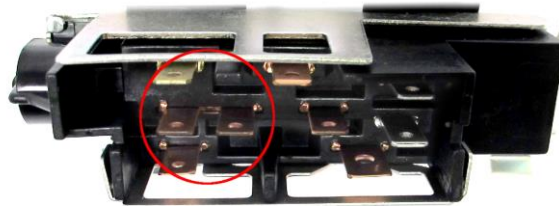
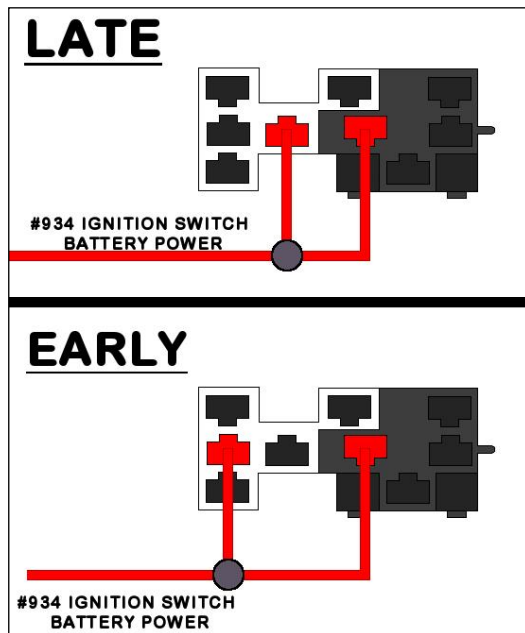

The connector is set up for late model and aftermarket switches. If you're using an early model, factory switch, you'll need to move the red wire as seen in the diagram to the left. Most aftermarket switches have bussed terminals (see image above) and the wire location will not matter.

Brown: 12 gauge wire, printed **#932 ACCESSORY POWER**, this wire carries power to the RADIO fuse on the fuse block. This **#932** wire will have power when the ignition is in the ACCESSORY position and when it is in the ON/RUN position.

- Locate the ignition switch on the top of the steering column facing the center of the vehicle. Route the two connectors to the ignition switch.
- The connectors must be installed in a specific order; the clear connector will need to be plugged in first, and then the black. Part of the black connector will overlap the clear.

Please be aware, the photo to the right is of a non-tilt column, tilt columns will have the clear connector closest to the firewall and the black connector closest to the steering wheel.

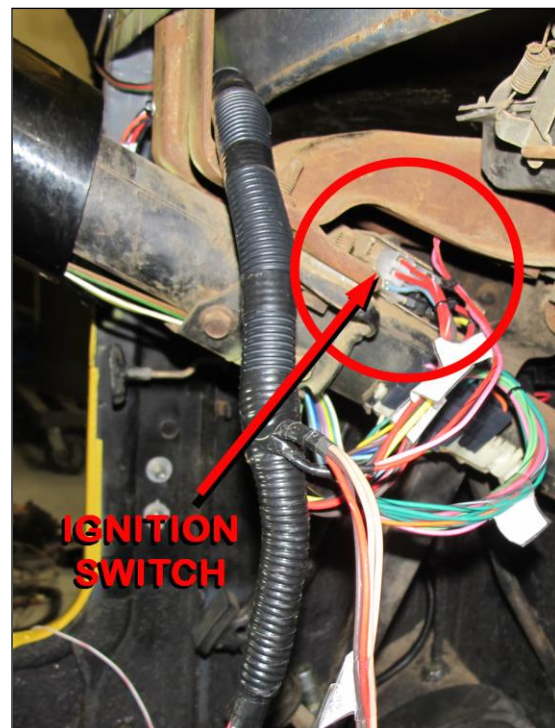

“Turn Signal Switch”

The column mounted turn signal switch will provide power to each turn signal indicator. The turn signal switch connection will exit the bottom of the steering column into a long connector. It can be seen just below-right of the red circle in the picture above.

The wires provided in the Painless harness for turn signal connection can be identified by the section label reading “TURN SWITCH”. These will be eleven pre-terminated wires with a black connector pre-installed. These wires can be seen in the [Turn Signal Schematic](#) on page 33, they are:

Black/White: 18 gauge wire, printed **#963 HORN RELAY GROUND ACTIVATION**, this wire is a ground activation signal to the horn relay. The only time this wire will be grounded is when the horn button on the steering wheel makes contact to a ground source.

Green/Black: 16 gauge wire, printed **#926 FRONT LEFT TURN SIGNAL POWER**, this wire provides power to the front left turn signal. This wire will have power anytime the hazard switch is activated and also when the turn signal lever is in the down/left turn position and the ignition switch is in the ON/RUN position. This wire is doubled up with the **#937** power wire to the left turn signal indicator on the gauge cluster

Green/Black: 18 gauge wire, printed **#937 LEFT TURN INDICATOR POWER**, this wire is a power activation wire for the left turn signal indicator. This wire will have interrupted switched ignition power, through the turn flasher, anytime the left turn signal is activated. It will also have interrupted switched battery power, through the hazard flasher, anytime the hazard switch is activated.

Green: 16 gauge wire, printed **#925 FRONT RIGHT TURN SIGNAL POWER**, this wire provides power to the front right turn signal. This wire will have power anytime the hazard switch is activated and also when the turn signal lever is in the up/right turn position and the ignition switch is in the ON/RUN position. This wire is doubled up with the **#938** power wire to the right turn signal indicator on the gauge cluster

Green: 18 gauge wire, printed **#938 RIGHT TURN INDICATOR POWER**, this wire is a power activation wire for the right turn signal indicator. This wire will have interrupted switched ignition power, through the turn flasher, anytime the right turn signal is activated. It will also have interrupted switched battery power, through the hazard flasher, anytime the hazard switch is activated.

Pink: 14 gauge wire, printed **#951 HAZARD SWITCH BATTERY POWER**, this wire provides power to the column mounted hazard switch. It comes from the hazard flasher found on the fuse block. It is a battery power wire but it will have power only when the hazard switch is activated, which causes the flasher to send power through this wire. See [Flashers](#) on page 22 of this manual to see how this process works.

Red/White: 14 gauge wire, printed **#952 TURN SIGNAL IGN. POWER**, this wire provides power to the turn signal switch. It comes from the turn signal flasher found on the fuse block. It is an ignition power wire but it will have power only when the turn signal switch is activated, which causes the flasher to send power through this wire. See [Flashers](#) on page 22 of this manual for how this process works.

Light Green/Black: 16 gauge wire, printed **#949 REAR LEFT TURN/BRAKE POWER**, this wire provides power to the left rear turn signal. This wire will have power anytime the hazard switch is activated and also when the turn signal lever is in the down/left turn position and the ignition switch is in the ON/RUN position. This wire also carries the brake light power wire and will also have power anytime the brake pedal is pressed.

Light Green: 16 gauge wire, printed **#948 REAR RIGHT TURN/BRAKE POWER**, this wire provides power to the right rear turn signal. This wire will have power anytime the hazard switch is activated and also when the turn signal lever is in the up/right turn position and the ignition switch is in the ON/RUN position. This wire also carries the brake light power wire and will also have power anytime the brake pedal is pressed.

Pink: 16 gauge wire, printed **#918 BRAKE SWITCH OUTPUT**, this wire will feed the brake light power into the turn signal switch. Jeeps have integrated brake/turn signals. Meaning, the turn signal and brake light share a filament in the bulb. This wire will have power anytime the brake pedal is pressed.

Orange: 18 gauge wire, printed **#930 GEAR INDICATOR LIGHT POWER**, this wire will provide a power to the gear indicator light found on columns with a shifter for automatic transmissions, seen in the picture to the right. This **#930** is tied to the other **#930** wires coming from the headlight switch to things like the radio backlight/dim, panel lights, and gauge cluster backlighting. This wire will have power anytime the headlight switch is in the Park/Tail Lights ON or Headlights On position. This wire can also be seen in the [Panel Light Schematic](#) on page 44.



- Locate the turn signal connector on the column and plug the connector on the new Painless harness into this connector. It will only connect in one way.

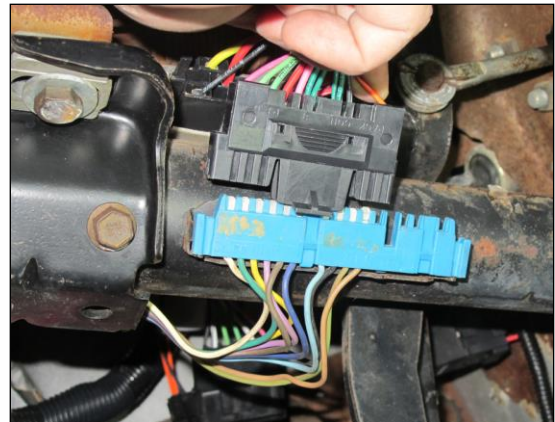

“Brake Switch”

Locate the brake switch at the top of the brake pedal, seen on the next page. This will be a small cylindrical switch that has a plunger that opens and closes the switch based on brake pedal position. The steering column may need to be unbolted from the dash and lowered to make this connection.

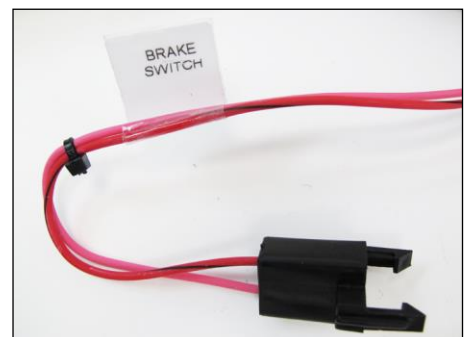

This switch is what is called normally closed, meaning the two terminals are connected together when the plunger is out. When it is installed, a flat metal tab connected to the brake pedal pushes the plunger in, causing the two contacts to not be connected. As the brake is applied, it this tab rotates away from the switch, allowing the plunger to extend, internally connecting the two posts of the switch.

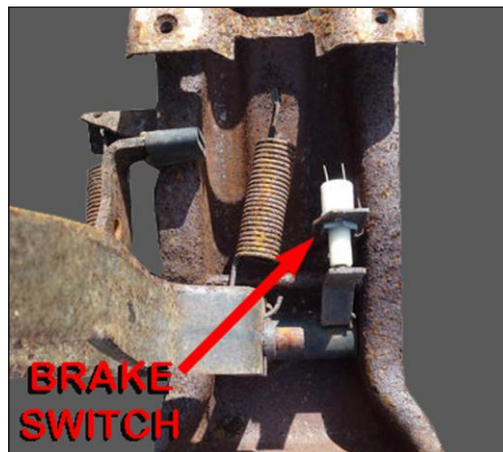

This switch requires two wires, a battery power wire from the fuse block and an output wire to the turn signal switch. The pre-installed connector, shown on the next page, will connect to the factory switch. If your switch differs from the connector provided, the connector can be cut off the harness and insulated terminals from the parts kit can be used to make individual wire connections to the brake switch.

The two wires of the Painless kit that make up the brake switch connection can both be seen in the [Turn Signal Schematic](#) on page 33; they are:

Red/Black: 16 gauge wire, printed **#917 BRAKE SWITCH POWER**, which provides power from the 15 amp STOP fuse. This wire will have power at all times.

Pink: 16 gauge wire, printed **#918 BRAKE SWITCH OUTPUT**. This wire supplies power from the brake switch to the brake lights. This wire goes to turn signal switch since Jeeps use integrated brake/turn signals.

- Route the brake switch wires to the brake switch and connect using the pre-installed connector or loose piece insulated terminals provided in the parts kit. Be sure to route the wires away from the moving parts of the brake pedal and/or clutch pedal.

If your brake switch has four connection pins, two pins will have contact or will be closed when the brakes are not applied and two will be separate or open when the brakes are not applied. You will need the 2 posts that are normally closed. The normally open pins are for cars equipped with cruise control or an automatic transmission with a lockup torque convertor, this harness does not provide wires these components.

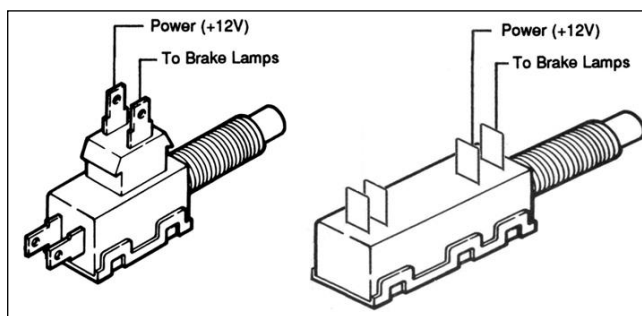

“Neutral Safety”

This switch sits inline of the wire coming from the “Start” terminal of the ignition switch to the “S” terminals of the starter solenoid.

This switch is a 2 pin, normally open, switch that has power coming into one side from the start position of the ignition switch and power going out the other side to the



starter solenoid “S” terminal.

This switch is a safety device that will prevent the vehicle from being started while in gear and causing an unfortunate accident. The purpose of this switch is to only allow the engine to be started when the vehicle is in park or neutral (automatic transmissions) or if the clutch is applied (manual transmissions). When the transmission is put into park/neutral or the clutch is applied, contact is made between these two pins, closing the switch. This allows current to flow from one pin to another, transferring power through the switch to the starter solenoid.

The neutral safety/clutch switch connection will have a section label reading “NEUTRAL SAFETY”. This will be a black 2 pin connector with 2 wires going to it, as seen above. These wires are:

Lt. Blue: 14 gauge wire, printed **#919 START SIGNAL (FROM IGN.SW. TO N.SAFETY)**, this wire comes from the Ignition switch. This wire is a switched ignition power wire. It will only have power when the ignition switch is in the START position. This wire can be seen in the [Starter Schematics](#) on pages 123 & 124 and on the [Ignition Switch Schematic](#) on page 32 of this manual.

Lt. Blue: 14 gauge wire, printed, **#919 START SIGNAL TO STARTER**, this wire provides power from the neutral safety to the Starter solenoid. This wire will have power when the ignition switch is in the START position AND the transmission is in park or neutral (automatic) or the clutch is applied (manual). This wire can be seen in the [Starter Schematics](#) on pages 123 & 124.

If you do not have a neutral safety at the column, but have one on the transmission, leave the connector loop plugged into the neutral safety connector. This loop will connect light blue #919 wires together. Connections for your transmission mounted NSS will be handled in the engine compartment harness on page 93. **Painless does not recommend operating your vehicle without a neutral safety/clutch switch.**

- Locate the Neutral Safety switch at the base of the steering column, if you have an automatic transmission.
- Unplug the neutral safety connector loop from the neutral safety connector, this loop is not needed and may be discarded, and plug the neutral safety connector on the Painless harness onto the two pins of the neutral safety/clutch switch.

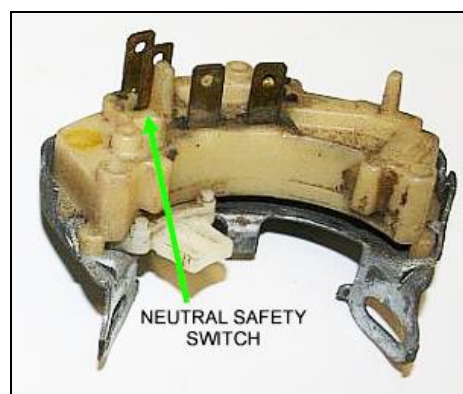

Those with an automatic transmission and an aftermarket floor mounted shifter, in most cases this switch will be found on the base of the shifter. This connection will need to be lengthened and routed to the shifter, as seen in the photo to the right. Small insulated terminals have been provided in the parts kit to accommodate aftermarket shifter NSS switches.

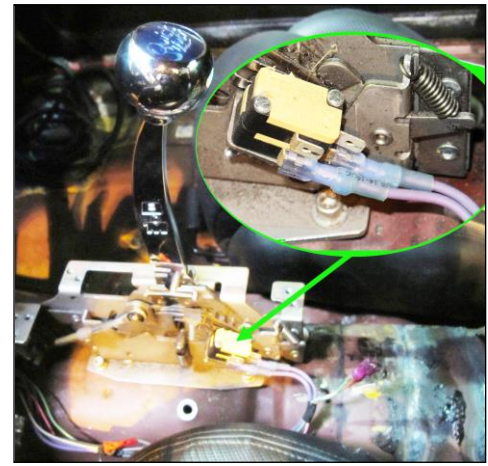

“Reverse Switch”

This connection only applies to those using a column mounted NSS/Reverse switch like shown below. Those with a transmission mounted reverse switch, this connection will be made using a connector found in the Engine Harness and discussed on page 91, skip this connection and continue to the “Dimmer Switch” connection on page 34.

The reverse switch connection will provide the backup lights the power they need to illuminate. This switch is a 2 pin switch that has power coming into one side and power going out the other side to the backup lights. When the shifter is put into the reverse position, contact is made between these two pins. This allows current to flow from one pin to another, transferring power through the switch out to the backup lamps.

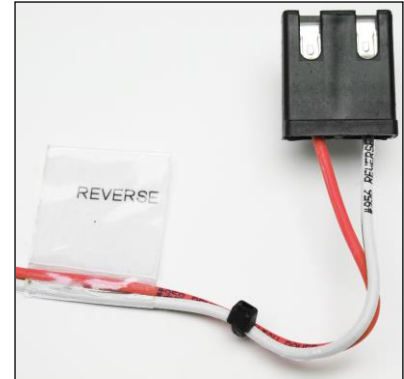

The reverse switch connection will have a section label reading “Reverse Switch”. This will be a black two pin connector with two wires going to it, seen in the photo above. These wires are:

Red: 16 gauge wire, printed **#958 REVERSE SWITCH POWER INPUT**, this wire comes from the 15 amp TURN/REVERSE fuse on the fuse block. This wire is a switched ignition power wire meaning it will only have power when the ignition switch is in the ON/RUN position.

White/Black: 16 gauge wire, printed **#956 REVERSE LIGHT POWER**, this wire provides power from the reverse switch to the backup lights in the Tail Section of the Painless harness.

- Locate the reverse switch at the base of the steering column.
- Plug the reverse switch connector onto the 2 pins of the reverse switch. As shown on the next page.

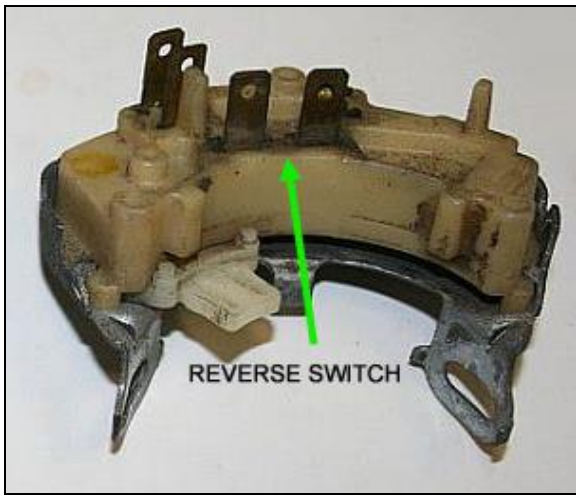

At this time the dash can be reinstalled over the column, **but do not re-install the mounting bolts at this time.**

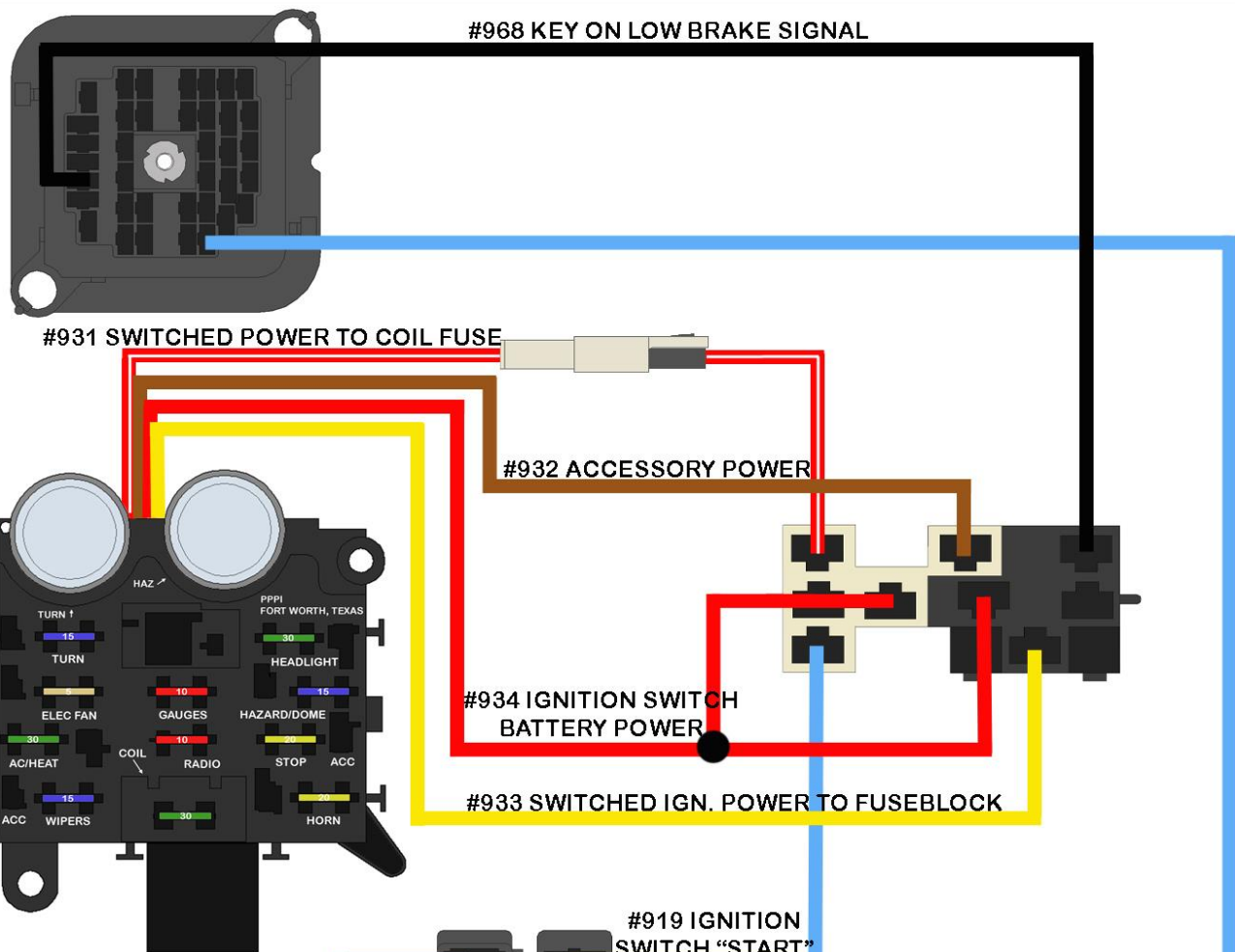
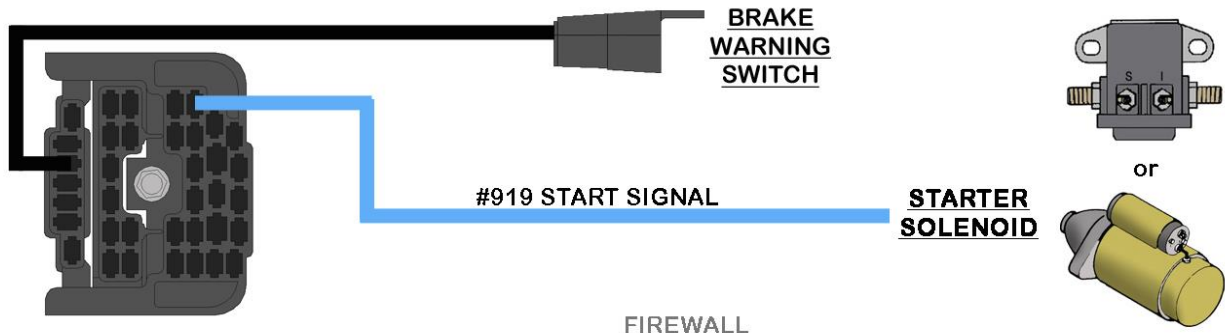

IGNITION SWITCH SCHEMATIC

NEUTRAL SAFETY SWITCH

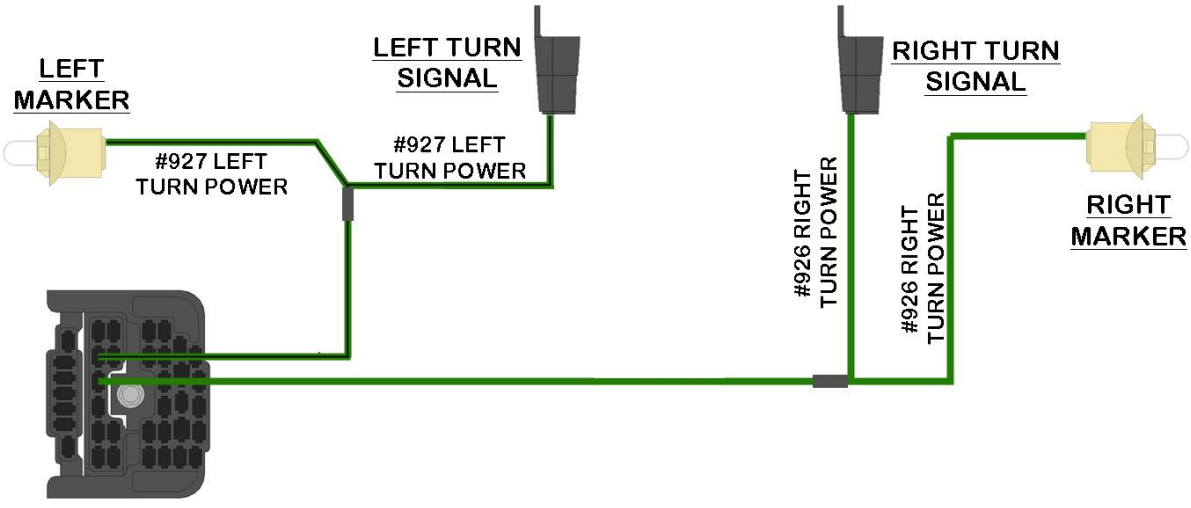

FIREWALL

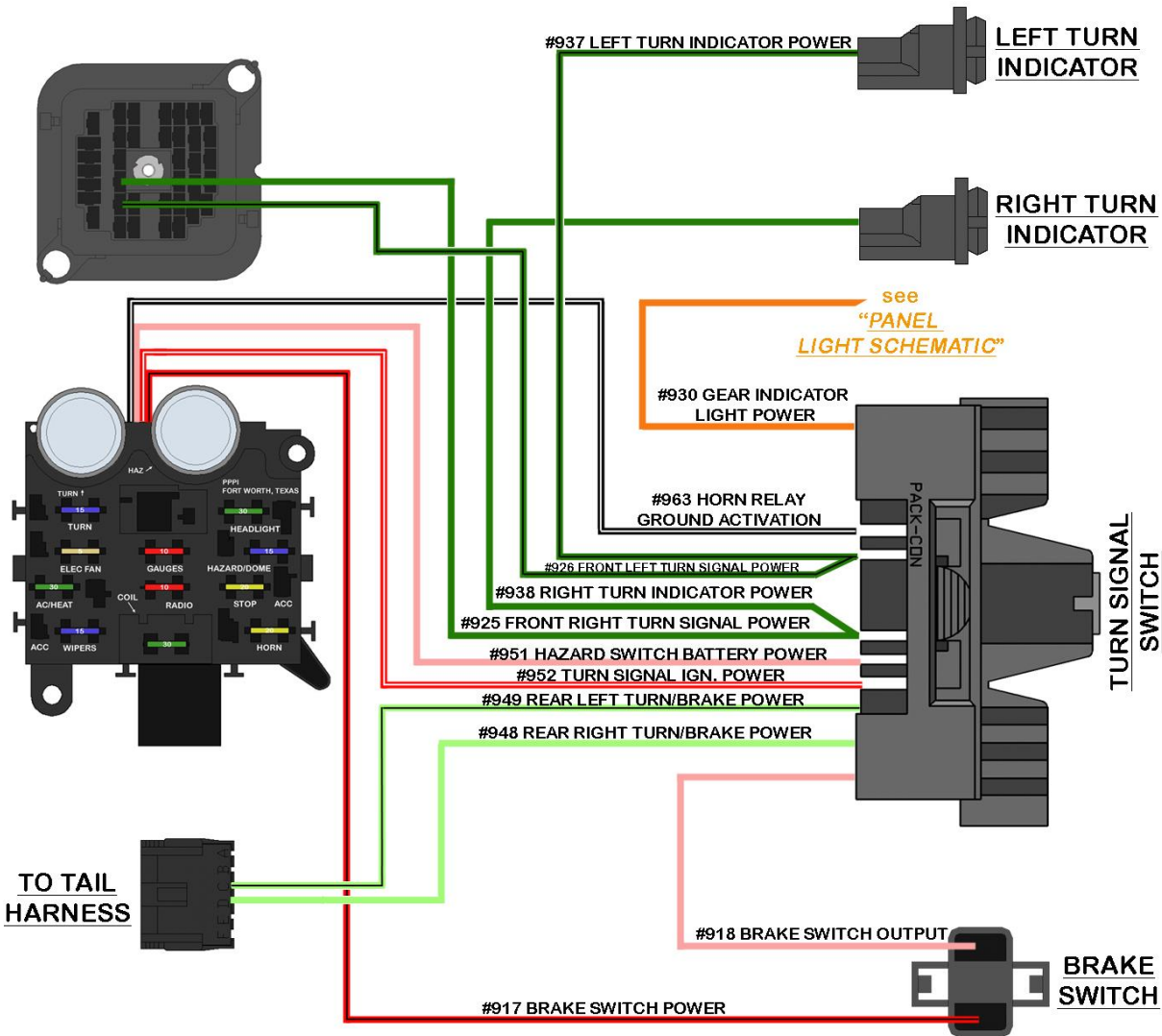

TURN SIGNAL SWITCH SCHEMATIC

The install of the remainder of the dash harness will begin with the connection closest to the fuse block and work down the harness towards the passenger side of the vehicle. Connections can be made from the top side of the disconnected dash.

“Dimmer Switch”

The dimmer switch can be found mounted on the floorboard to the left of the clutch/brake pedals. The dimmer switch receives power from the headlight switch and based on the position of the switch will send power to the low beam or high beam wire.

Coming out of the bottom of the fuse block you will notice wires grouped together with a section label reading “DIMMER SWITCH”. These wires have a large black 3 pin connector preinstalled. The three wires that make up the connection to the dimmer switch can be seen in the [Headlight Switch Schematic](#) on page 43, they are:



Red/White- 14 gauge wire, printed **#907 DIMMER SWITCH POWER**, this comes from the headlight switch and will have power whenever the headlight switch is in the *HEADLIGHT ON* position.

Gray- 14 gauge wire, printed **#909 LOW BEAM POWER**, this wire provides power through the bulkhead to the low beam filament of the headlights whenever the dimmer switch is in the low beam position and the headlight switch is in the *HEADLIGHT ON* position.

Gray/Red- 14 gauge wire, printed **#908 HIGH BEAM POWER**, this wire provides power through the bulkhead to the high beam filament of the headlights as well as power to the high beam indicator in the dash whenever the dimmer switch is in the HIGH beam position and the headlight switch is in the *HEADLIGHT ON* position.

- Remove the two screws holding the dimmer switch to the floor board if it is currently mounted.



- Plug the black three pin connector onto the dimmer switch, you will notice the connector will also go underneath the switch and will line up to the mounting holes.
- Using the original screws or two of the black $\frac{3}{4}$ " long self tapping screws found in the parts kit, mount the dimmer switch to the floor board. There should be adequate length on the wires to enable you to re-use the existing holes in the floor.

Your headlights will not function unless the dimmer switch connector is connected to a functioning dimmer switch.

“Parking Brake Switch”

Of the wires coming out of the top of the fuse block, the first connection you come to is two wires labeled “PARKING BRAKE SWITCH”. The parking brake switch sends a ground signal from the switch to the brake indicator light on the gauge cluster, illuminating the light if the parking brake is engaged and the ignition switch is in the ON/RUN position.

Jeeps without a factory cluster will no longer have this brake indicator light, this wire will have no function, and can be removed from the harness.

This portion of the harness will have two wires. One will have an insulated socket terminal pre-installed; this wire is:



Black: 18 gauge wire, printed **#968 BRAKE WARNING SIGNAL**, this wire sends a ground source to the brake warning light in the dash, causing it to illuminate when the parking brake pedal is down. This wire can be seen in the [Gauge Cluster Schematic](#) on page 62.

- Route the black **#968** wire to the parking brake switch towards the bottom rear of the parking brake assembly, see photo.
- Connect the **#968** to the stud coming from the parking brake switch.

Some switches may have a tab, if you find this is the case on your Jeep, simply cut the pre-installed socket terminal from the **#968 wire**, and install one of the light pink colored heat shrinkable terminals found in the parts kit.

One other wire can be found in this section, it is intended to provide a clean ground source to the parking brake assembly for those using fiberglass bodies. Those using factory steel bodies can remove this wire or connect it to a common chassis ground location.

This single open ended wire is:

Black/White: 18 gauge wire, printed **#969 PARKING BRAKE GROUND**, this wire is part of the integrated ground distribution supplied throughout the harness and is tied directly back to the negative side of the battery. This wire can be seen in the [Ground Schematic](#) on page 14.

- Using a ring terminal from the parts kit, connect this wire to the mounting screw holding the switch to the parking brake pedal assembly, as shown in the photo above. Make sure the contact area is clean of paint/dirt/rust.

“Dome Light”

The next connection is an optional equipment connection, meaning not all installs will require the use of this connection. A section label reading “DOME LIGHT” identifies a connection that will provide power and ground for a dome/courtesy light connection commonly found on most hard tops. This connection will also allow you to install [Painless part #30710](#), a universal courtesy light kit, if under dash lighting is desired.

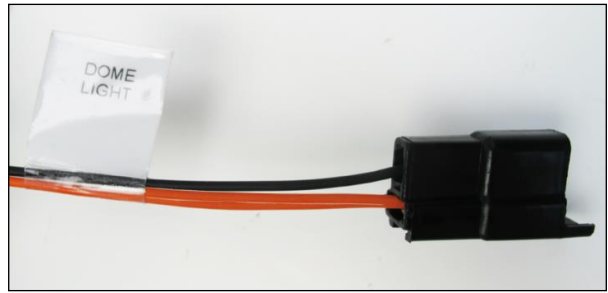

The dome light connection will have 3 wires going into a two pin black connector; these wire are:

Orange: 18 gauge wire, printed **#971 COURTESY/DOME LIGHT POWER**, this is a battery power wire that comes from the 15 amp “HAZ/DOME” fuse on the fuse block. This wire will provide constant power to the dome/courtesy light(s).

Orange: 18 gauge wire, printed **#971 UNDER HOOD LIGHT POWER**, this wire is doubled with the other **#971** wire to get battery power from “HAZ/DOME” fuse. This wire is providing power through the bulkhead connector, out into the engine compartment to provide power to a under hood light.

Black: 18 gauge wire, printed **#961 COURTESY/DOME LIGHT GROUND**, this is a ground activation wire from the headlight switch. When the headlight switch is rotated to the *DOME LIGHT ON* position, the ground source from the mounting of the headlight switch will be connected to this wire, providing the bulb with a path to ground. This path to ground allows voltage to pass through the bulb, causing it to illuminate.

To make the connection to factory dome lights found on hard tops, you will need to reuse the two wire extension that runs from the dash to the rear of the Jeep from your factory harness. This extension harness will be single orange and single black wires that will go from a “T” shaped connector, mates to the connector shown above, and there will be a white two pin connector in the rear, seen in the photo to the right. These will be the only orange and black wires in the factory tail harness.



- The extension harness will need to lay out on the floor with the tail light harness found in this 10150 Jeep wire harness kit. Incorporate the extension harness into the loom provided on the tail light harness, as it was on the factory harness and as shown above.
- The dome light connection will not be made at this time, we will come back to it and make this connection when the Tail Harness is installed, page 123.

Those wanting to add under dash courtesy lights, Painless offers part [#30710](#). This will be two pre-wired under dash lamp sockets with bulbs. A connector and terminals have been included in the parts kit of the 10150 to easily adapt [#30710](#) to plug right into the dome light connection found on your new Jeep chassis harness.



Since light socket mounting may not be possible at this time with the dash not installed, the following steps may need to be accomplished after the remainder of the dash harness has been installed and when the dash has been remounted.

- Locate the terminals and connector found in the 10150 parts kit and, seen in the photo, which mates to the dome light connector found on the 10150 harness.
- Using the screws provided with the [#30710](#) kit or 4" zip ties from the chassis harness kit, mount one light socket on the passenger side of the vehicle above the passenger side foot well. Route the black and white wires from the light socket towards the dome light connector found on the chassis harness.



Mount the remaining light socket above the driver side foot well and route the black and white wires towards the dome light connector.

- At this point all four wires of the [#30710](#) courtesy light kit should be at the dome light connector, cut all four wires (two black and two white) to length so that when a connector is installed on these wires they can easily reach the dome light connector. Once cut, strip $\frac{1}{4}$ " of insulation from each wire.
- Using a set of roll over crimpers, install one of the supplied terminals (see above) onto both white wires. To clarify, this will be two wires into one terminal. Do the same for the black wires.
- Insert the white and black wires into the supplied connector so that once the connector is plugged into the 10150 harness, the white wire will connect to the orange [#971](#) wires and the black wire will connect to the [#969](#) wire.
- Plug the connector now on the courtesy light wires into the dome light connector found on the harness.

“TO TAIL HARNESS”

A six pin connector labeled “TO TAIL HARNESS” will allow a weather proof connection to the tail light harness. This connector is an upgrade to the inline connection found on the factory harness. This connector has six wires pre-terminated and installed, these wires can all be seen in various schematics throughout this manual; these wires are:

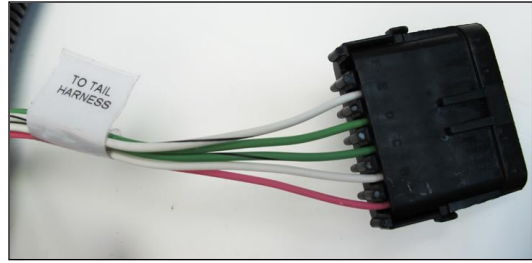

Pink: 18 gauge wire, printed **#939 FUEL LEVEL SIGNAL**, this wire will send a resisted ground signal from the fuel level sending unit to the fuel gauge. This wire can also be seen in the [Gauge Cluster Schematic](#) on page 62.

Light Green/Black: 16 gauge wire, printed **#949 REAR LEFT TURN/BRAKE POWER**, this wire provides power to the left turn signal. This wire will have power anytime the turn signal is in the DOWN position and the ignition switch is in the ON/RUN position or anytime the hazard switch is activated. This wire is also the brake light power and will also have power anytime the brake pedal is pressed. This wire can be seen in the [Turn Signal Schematic](#) on page 33.

Light Green: 16 gauge wire, printed **#948 REAR RIGHT TURN/BRAKE POWER**, this wire provides power to the left turn signal. This wire will have power anytime the turn signal is in the UP position and the ignition switch is in the ON/RUN position or anytime the hazard switch is activated. This wire is also the brake light power and will also have power anytime the brake pedal is pressed. This wire can be seen in the [Turn Signal Schematic](#) on page 33.

White: 16 gauge wire, printed **#927 TAIL LIGHT POWER**, this wire will provide the tail lights and rear side marker lights power. This wire receives power from the headlight switch and will have power anytime the headlight switch is pulled into the first or second positions. This wire can be seen in the [Headlight Switch Schematic](#) on page 43.

White/Black: 16 gauge wire, printed **#956 REVERSE LIGHT POWER**, this wire will provide power to the reverse or back up lights. This wire receives power from the reverse switch and will have power anytime the shifter/transmission is in the REVERSE position.

Black: 18 gauge wire, printed **#969 TAIL HARNESS GROUND**, this wire is part of the integrated ground distribution supplied throughout the harness and is tied directly back to the negative side of the battery. This will supply a clean ground source to the rear of the Jeep for those using fiberglass bodies. This wire can also be seen in the [Ground Schematic](#) on page 14.

Connecting the tail harness will not be made at this time. This connection will take place when the Tail harness is installed, page 126.

“Ground”

The wires labeled “GROUND” will be wires doubled up into a single small ring terminal. This connection will do two things: provide a clean ground source to all the instruments/lights found on the dash and also, provide a clean ground source to the dash on vehicles with a fiberglass body/tub. These wires can be seen in the [Ground Schematic](#) on page 14, they are:



Black: 14 gauge wire, printed **#969 TO CHASSIS GROUND**, this wire provides a ground source to the many indicator lights found across the dash through a series of splices. This wire is also doubled up with another **#969** wire at this ground connection which makes it part of the integrated ground circuit.

Black: 12 gauge wire, printed **#969 CHASSIS GROUND SOURCE**, this part of the integrated ground circuit. This wire will provide a good clean ground source to the dash for those using fiberglass bodies/tubs. This wire also provides a clean ground source for the other **#969** wire found doubled up at this connection.

- Find a suitable ground location for this connection. If the location you choose requires a larger ring terminal to utilize an existing bolt, ring terminals of various sizes have been provided in the parts kit.
- If a ground source cannot be located or if you are unsure of a proper grounding location, Painless recommends creating a ground connection on the steering column brace, see the photo below.
- Using sand paper or some other abrasive, clean any paint, dirt, or surface rust from a dime sized area in which the pre-installed ring terminal can reach.
- Locate a ½” long self tapping screw and small star washer from the parts kit. Using a ¼” nut driver and a drill, make the ground connection with the star washer between the brace and the ring terminal.
- A #10 bolt, 2 star washers, and a nyloc nut are also provided, if you wish to install this ground to an existing hole.

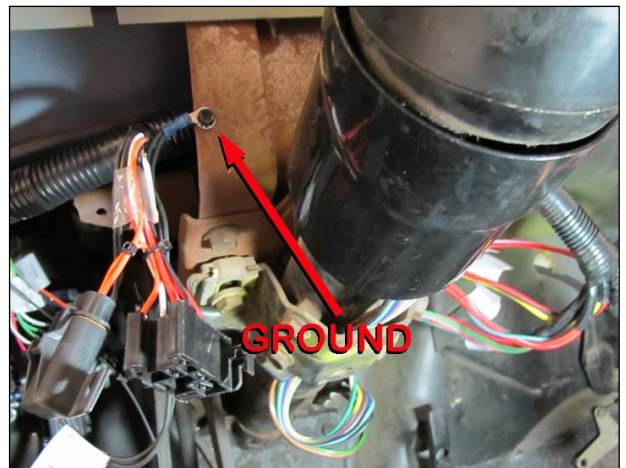

This ground connection can also provide a clean ground source to a junction block. Those with numerous aftermarket components tend to like to use junction blocks so all components share a common grounding point. Painless offers part #'s [80114](#), [80115](#), & [80116](#) to fill these needs.



“Headlight Switch”

The headlight switch connection will control functions of the park/tail lights, headlights, gauge lights, and the dome/courtesy lights. This will be a three way switch:

- The first pull of the headlight switch will send power to illuminate the park lights, tail lights, and also the backlighting for the gauges.
- The second pull of the switch will still provide power to everything listed above, but will now send power to the dimmer switch which will then route power to the high beam or low beam headlights depending on the dimmer switch position.
- The third position is dome light/courtesy light control and gauge dimming. By rotating the knob to the left and right, you can dim/brighten the gauge backlighting. This is done through the rheostat (the coiled metal that looks like a spring) on the switch that resists the power going to the gauge lights. Turn the knob to the left, counter clockwise, to make the gauges brighter, all the way to the left you will feel a click; this click will provide a ground source out to the interior lighting circuit causing the dome/courtesy lights to come on. Turning the knob to the right will turn the interior lights off and will begin to dim the gauge backlighting.

The headlight switch connection on the Painless harness comes with four pre-installed connectors: a black 6 pin connector for the headlight switch, 2 single pin connectors for the indicator light (not shown), and a connector housing an inline fuse for the gauge lighting. The wires going into these connectors can all be seen in the [Headlight Switch Schematic](#) on page 43.

Six pin connector:

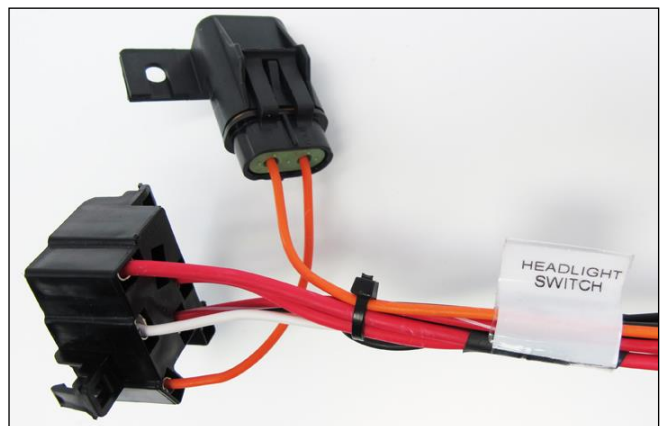

2 Red: 12 gauge wires, not printed due to their short length, but are spliced to a wire printed **#928 HEADLIGHT SWITCH POWER**, these wires provide constant battery power to the headlight switch for headlight operation as well as for the park/tail lights. The **#928** wire comes from the 30 amp HEADLIGHT fuse on the fuse block.

White: 16 gauge wire, printed **#927 PARK LIGHT POWER**, this wire supplies power to the park lights and tail lights. This wire will have constant battery power any time the headlight switch knob is pulled out in both the first and second positions.

Red/White: 14 gauge wire, printed **#907 DIMMER SWITCH POWER**, this wire supplies power to the dimmer switch for headlight operation. This wire will have constant battery power anytime the headlight switch knob is pulled out in the second position.

Orange: 16 gauge wire, not printed, this wire provides power to the gauge lights. This wire will have constant battery power any time the headlight switch knob is pulled out in either the first and second positions. This wire supplies power to the inline fuse found near the headlight switch, further explained on the next page

If the knob of the headlight switch is rotated all the way to the right, you will not have power on this wire. If you do not have power to the gauge lights during testing, first check the knob position.

Black: 16 gauge wire, printed **#961 COURTESY/DOME LIGHT GROUND**, this wire provides the ground source for interior light activation. This wire will be grounded through the switch which receives ground through the mounting of the switch to the metal dash.

- Plug the connector onto the switch; the connector will only fit one way.

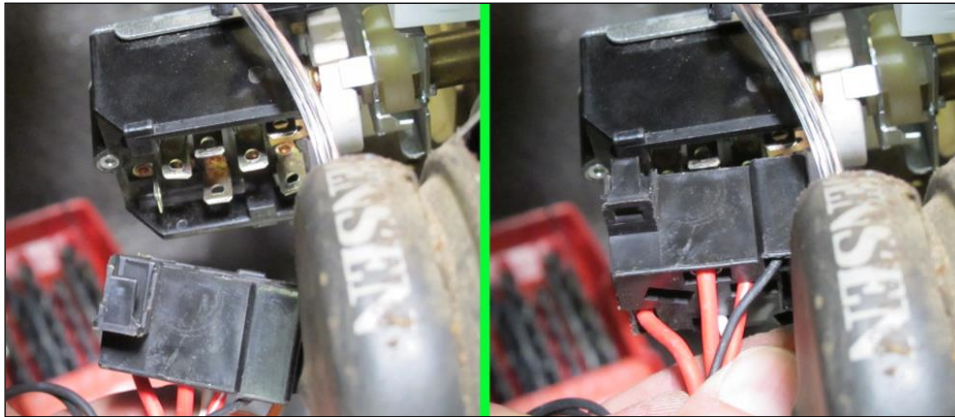

Single pin connectors:

Orange: 18 gauge wire, not printed, this wire will provide a power to the headlight dash label light. This wire comes from the inline fuse and is part of the **#930 PANEL LIGHT POWER** circuit and is tied to the other **#930** wires coming from the inline fuse at the headlight switch. This wire will have power anytime the headlight switch is in the Park/Tail Lights ON or Headlights On position. This wire can be seen in the [Panel Light Schematic](#) on page 44. This wire is also doubled into this single pin connector with another orange wire; this other wire is identified below.

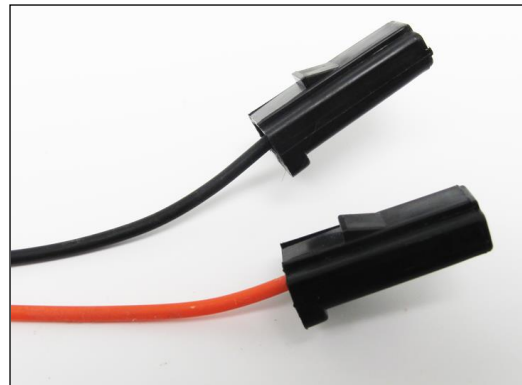

Orange: 18 gauge wire, printed **#930 CLOCK BACKLIGHT POWER**, this wire will provide a power source to the backlight found on factory clocks. This wire is supplied power through being doubled up with the orange wire providing power to the headlight dash label light power and will have power anytime the headlight switch is in the Park/Tail Lights ON or Headlights On position. This wire can also be seen in the [Panel Light Schematic](#) on page 44.

Black: 18 gauge wire, printed **#969 HEADLIGHT DASH LABEL GROUND**, this wire provides a ground source to the headlight dash label/ panel light found above the headlight switch on the dash. This wire receives ground through the series of splices that makes up the integrated ground circuit. This wire is also doubled up with another #969 wire at this connection, see below.

Black: 18 gauge wire, printed **#969 CLOCK BACKLIGHT GROUND**, this wire will provide a good clean ground source to the factory clock backlight. This wire is part of the integrated ground circuit through it being doubled up with **#969 HEADLIGHT DASH LABEL LIGHT GROUND**.

- Connect each of the black single pin connectors to the tabs of the dash label light above the headlight switch, it does not matter which connector goes where on the light, only that it receives power to one side and ground to the other.



In line fuse:

This in line fuse is in place to provide fused protection to the panel/gauge backlighting. Without this inline fuse, a short on any of the numerous **#930** wires in this harness would cause the headlight fuse to pop, and the headlights inoperable causing safety issues during night time driving. These wires can be seen in the [Panel Light Schematic](#) on page 44, they are:

Orange: 16 gauge wire, not printed, this wire provides power to the in line fuse from the headlight switch. This wire will have constant battery power, from the “HEADLIGHT” fuse anytime the headlight switch knob is pulled out in either the first or the second position.

Orange: 16 gauge wire, printed **#930 PANEL LIGHT POWER**, this wire provides power out of the inline fuse to the **#930 PANEL LIGHT POWER** circuit through a series of splices. This wire will have power anytime the headlight switch is in the Park/Tail Lights ON or Headlights On position. This wire is doubled up with another wire, see below, at the in line fuse.

Orange: 18 gauge wire, not printed, this wire will provide a power to the headlight dash label light. This wire comes from the inline fuse and is part of the **#930 PANEL LIGHT POWER** circuit is tied to the other **#930** wires coming from the inline fuse at the headlight switch. This wire will have power anytime the headlight switch is in the Park/Tail Lights ON or Headlights On position.

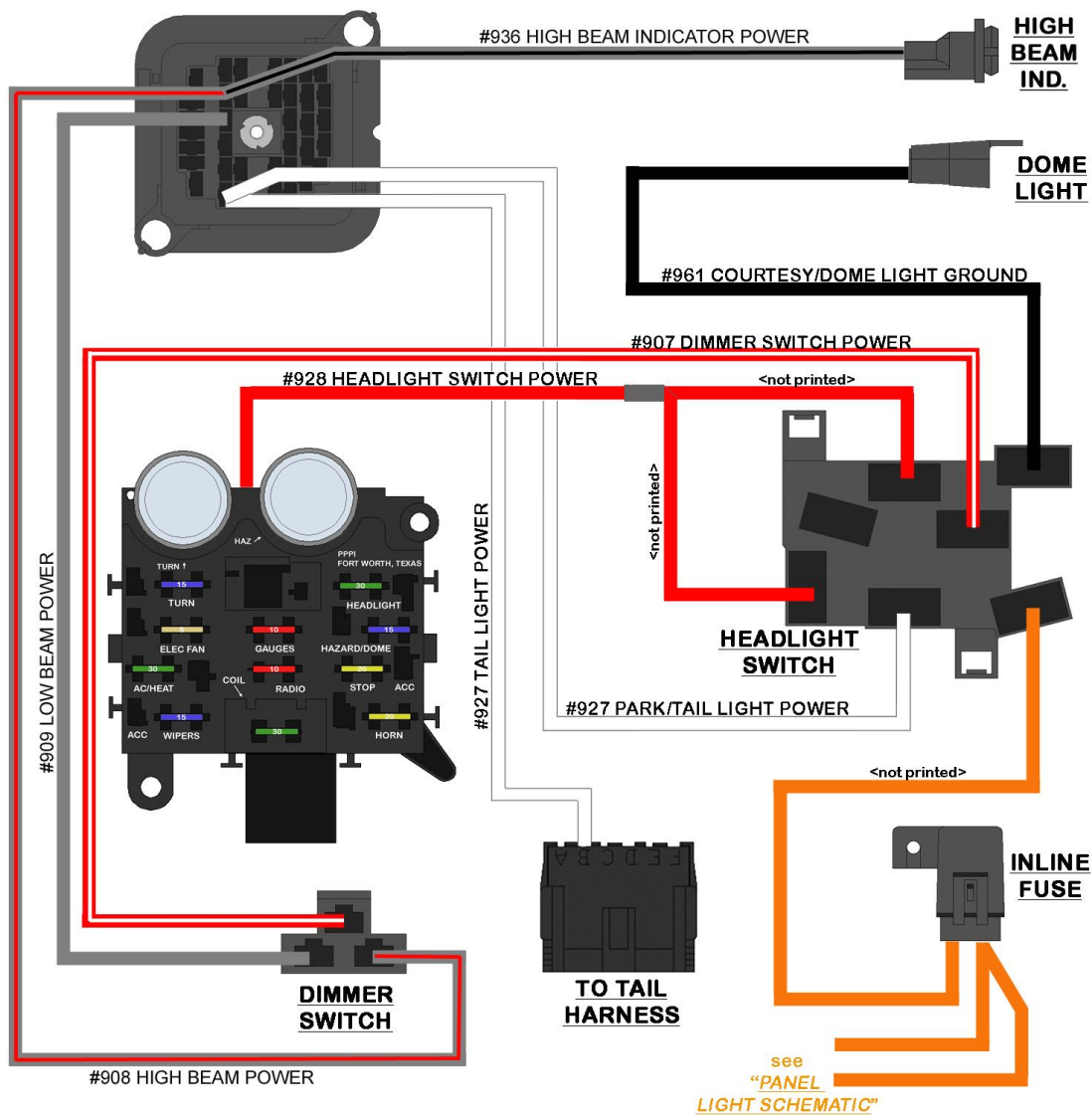
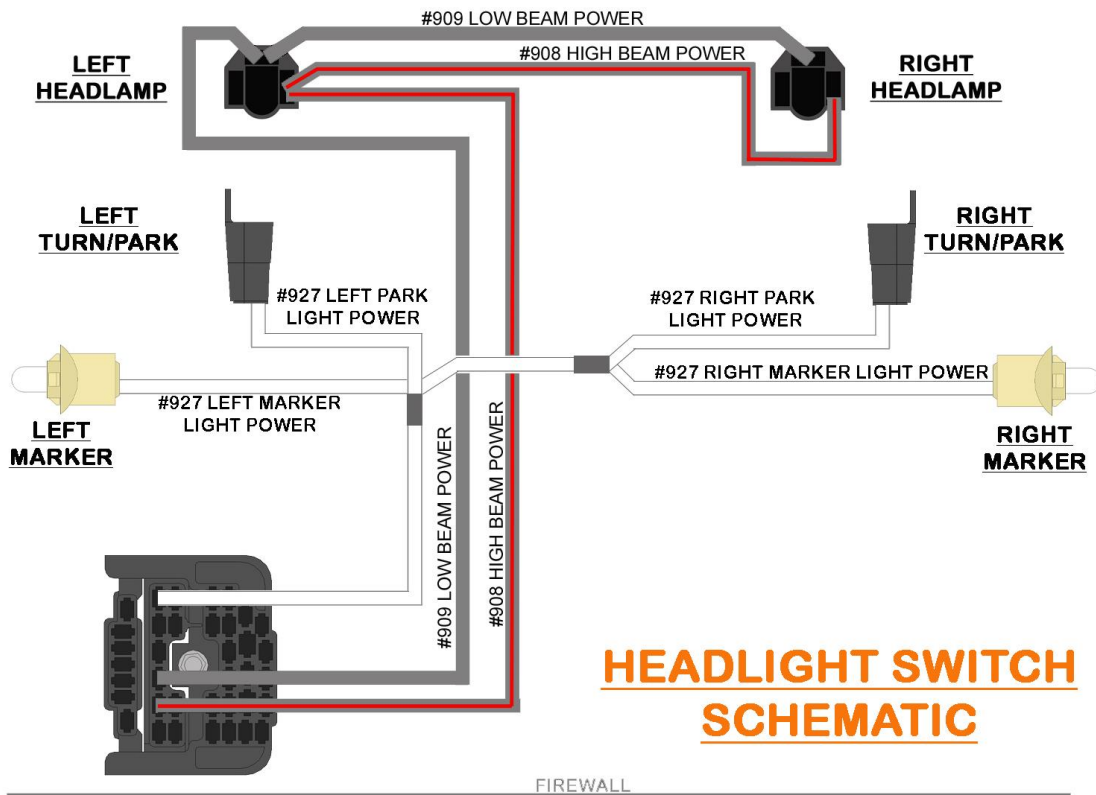

PANEL LIGHT SCHEMATIC

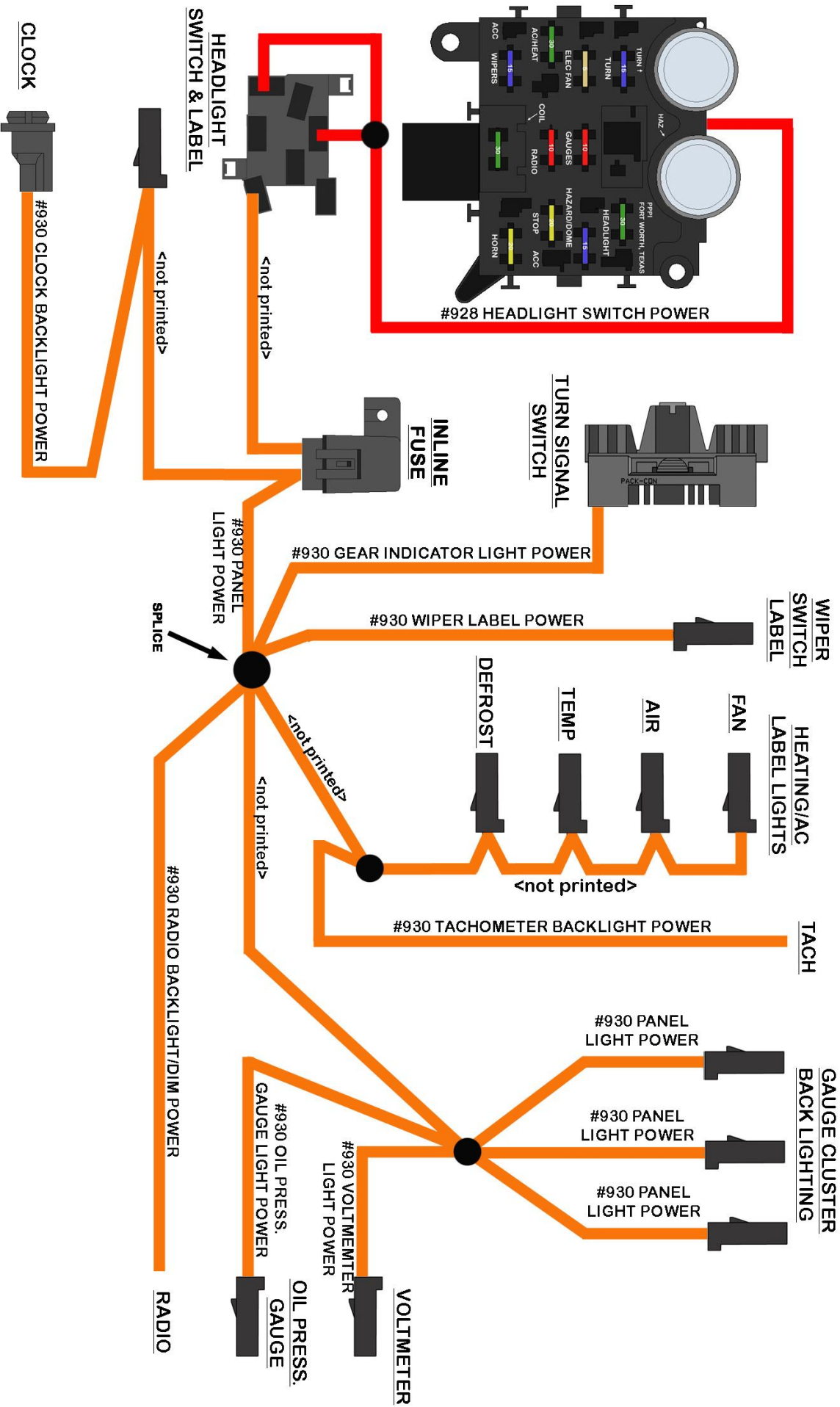

“Clock”

The next connection is an optional equipment connection, meaning not all installs will require the use of this connection. A section label reading “CLOCK” identifies connections that will provide power and ground for clock function, as well as a light socket to provide backlighting of the clock. Factory installed clocks are mounted to the left of the steering column, above the headlight switch.

The clock connection will have 2 wires going into a two pin black connector, and 2 wires going into a light socket. These wires are:



2 pin connector:

White/Red: 18 gauge wire, printed **#965 CLOCK BATTERY POWER**, this is a battery power wire that comes from the 20 amp “HORN” fuse on the fuse block. This wire will provide constant power to the clock.

Black: 18 gauge wire, printed **#969 CLOCK GROUND**, this wire is part of the integrated ground distribution supplied throughout the harness and is tied directly back to the negative side of the battery. This will supply a clean ground source to the clock. This wire can also be seen in the [Ground Schematic](#) on page 14.

Light Socket:

Orange: 18 gauge wire, printed **#930 CLOCK BACKLIGHT POWER**, this wire is part of the #930 panel light circuit through a series of splices. This wire will have power anytime the headlight switch is in the Park/Tail Lights ON or Headlights On position. This wire can be seen in the [Panel Light Schematic](#) on page 44.

Black: 18 gauge wire, printed **#969 CLOCK BACKLIGHT GROUND**, this wire is part of the integrated ground distribution supplied throughout the harness and is tied directly back to the negative side of the battery. This will supply a clean ground source to the clock. This wire can also be seen in the [Ground Schematic](#) on page 14.

- Insert a bulb from the parts kit into the lamp socket.
- Route the two connections to the clock and connect. As seen in the photo to the right, locations of the connector and socket are easy to determine.



Those using aftermarket clocks will notice the back of the clock is different from that of the factory one pictured on the previous page. Aftermarket clocks generally have three wires coming from the back: red, black, and green. Red being power to the clock, black being ground for the clock and illumination, and green being the power for illumination. See the directions for your particular clock.

Connections to an aftermarket clock will require you to cut the preinstalled connector and light socket from the Painless harness.

- At this time, cut the connector and light socket from the clock connection wires of the Painless harness. Once cut, strip ¼" of insulation from each of the wires.
- Insulated terminals have been provided in the parts kit to make inline connections to the wires on the aftermarket clock and to the Painless harness. The clock will require blue insulated terminals (blue are for 14-16 gauge) and red terminals for the wires of the Painless harness (red are for 18 gauge).
- Connect the wires according to the diagram below.



NOTES

“Wiper Switch”

The wiper connection found on the harness will consist of 4 single pin connectors. 2 connectors for the wiper switch, and 2 connectors for the dash label light above the wiper switch. The Painless harness will provide power to the wiper switch and to the dash label light, a ground to the dash label light, as well as power from the wiper switch to the washer pump in the engine compartment. These four connectors will have the following wires:

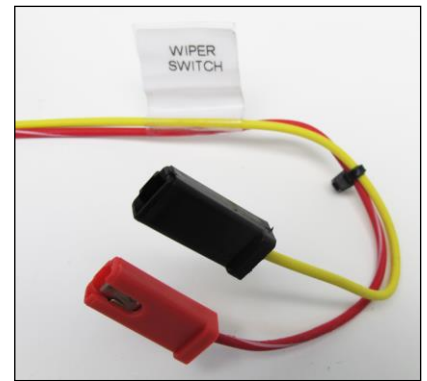

Red/White: 16 gauge wire, printed **#982 WIPER SWITCH POWER**, this wire will provide switched ignition power to the wiper switch from the 15 amp “WIPER” fuse. This wire will have power anytime the ignition switch is in the *ON/RUN* position. This wire will have a red connector pre-installed.

Yellow: 16 gauge wire, printed **#983 WASHER POWER**, this wire will provide power to the washer pump when the wiper switch is in the *WASH* position.

Orange: 18 gauge wire, printed **#930 WIPER LABEL POWER**, this wire is part of the **#930** panel light circuit through a series of splices. This wire will have power anytime the headlight switch is in the Park/Tail Lights ON or Headlights On position. This wire can be seen in the [Panel Light Schematic](#) on page 44.

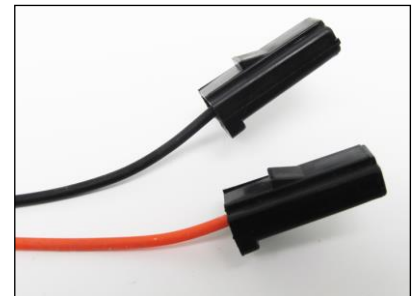

Black: 18 gauge wire, printed **#969 WIPER LABEL GROUND**, this wire is part of the integrated ground distribution supplied throughout the harness and is tied directly back to the negative side of the battery. This will supply a clean ground source to the wiper label. This wire can also be seen in the [Ground Schematic](#) on page 14.

1976-1982:

- Begin by routing all four single pin connectors to the wiper switch.
- Connect the red connector with the **#982** wire and the black connector with the **#983** wire as indicated in the photo below.

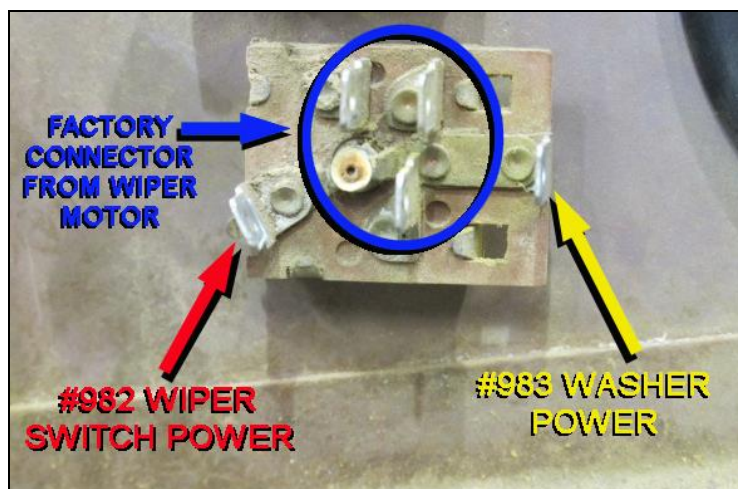

- Connect the two remaining black single pin connectors to the tabs of the dash label light above the wiper switch, it does not matter which connector goes where on the light, only that it receives power to one side and ground to the other.



- The wiper motor will have three wires hard wired directly to it. These wires will have a pre-installed connector that fits the remaining three prongs on the back of the wiper switch. Connect the wires of the wiper motor to the wiper switch.

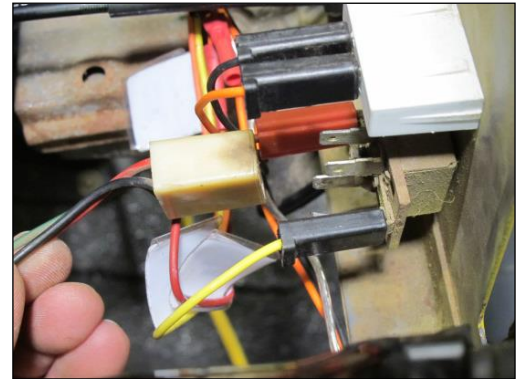

1983-1986:

A pig tail has been provided for those with "Ford" style wiper switches. These were factory installed on CJs in 1983-1986. This pigtail will plug into the wiper switch, the wiring from the wiper motor, and onto two wires found on the Painless harness.

Those with intermittent wipers, this pigtail will plug onto the female connector coming from the wiper module. The red connector on your module, will plug onto your switch.

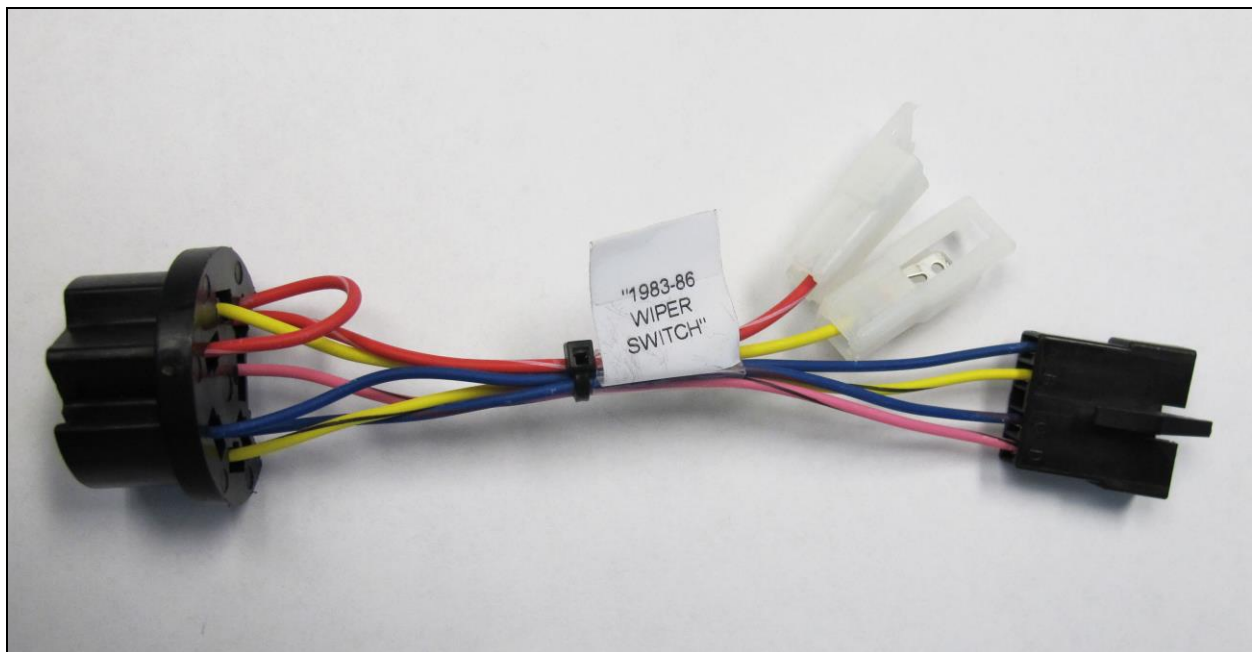

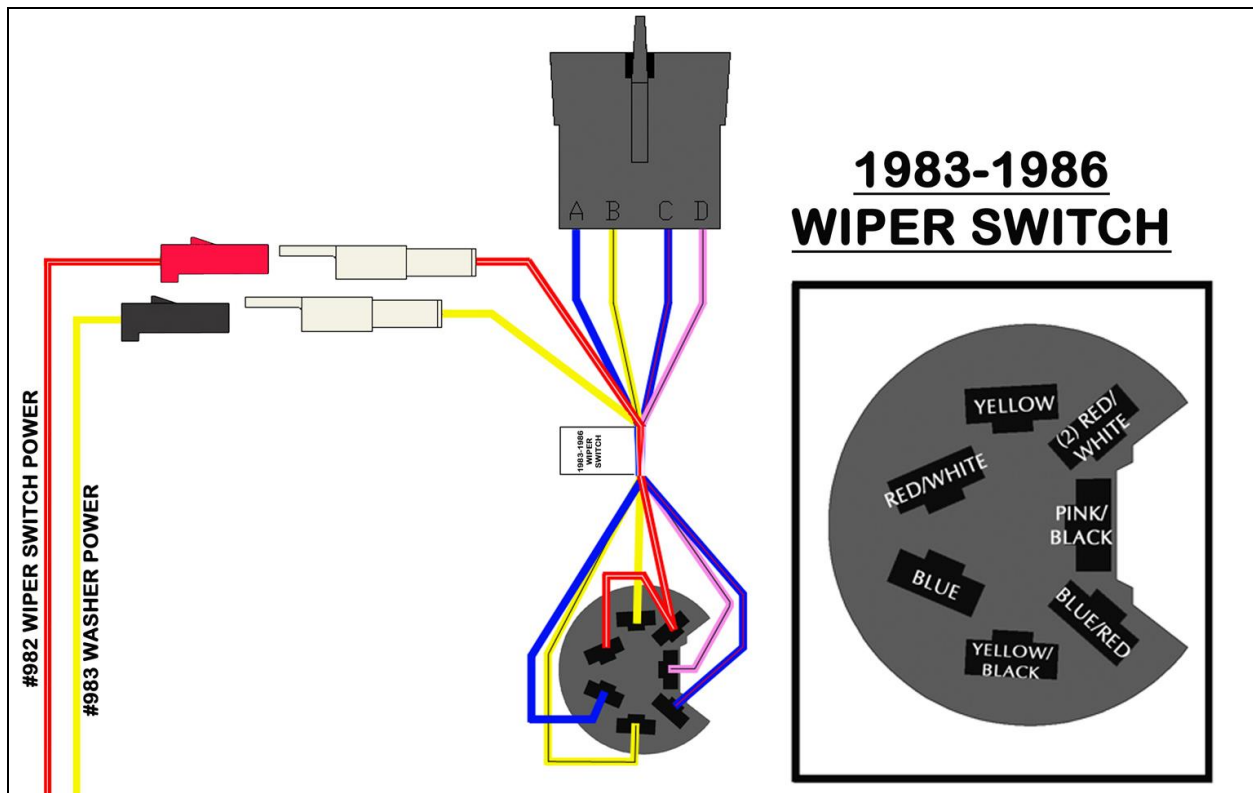

- Plug the round connector of the pigtail onto the wiper switch. It will only plug in one way.

Once the pigtail has been connected to the switch, the three remaining connectors on the pigtail will need to be connected.

- Connect the transparent connector with the red/white wire on the pigtail to the red/white wire, **#982**, on the new Painless harness.
- Connect the transparent connector with the yellow wire on the pigtail to the yellow wire, **#983**, on the new Painless harness.
- Connect the 4 pin black connector on the wiper switch pigtail to the connector coming from the wiper motor, as seen in the photo.

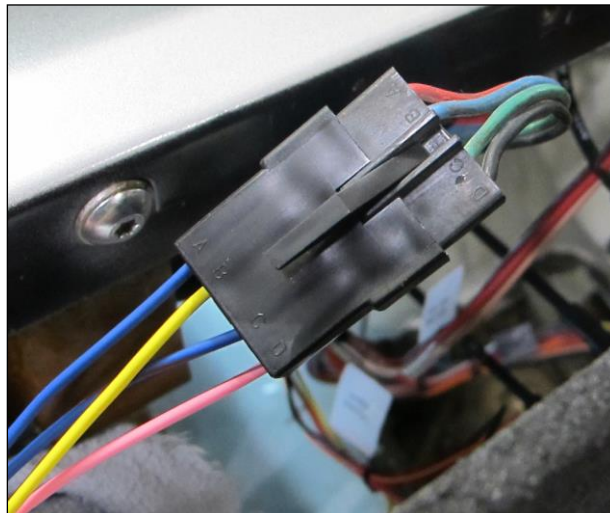

“Blower Switch”

This Painless harness is set up for 3 speed systems, those with earlier 2 speed systems will need to make slight modifications to the harness, as described.

The blower switch connection will come with a five pin black connector pre-installed. This connector will have one cavity that is empty, this is intentional and not an error during production of the harness. The wires found in this connection will transfer power from the switch, and depending on the speed selected, through the blower resistor, to the blower motor. These wires can all be seen in the [3 Speed Heater Schematic](#) on page 51, they are:



Red: 14 gauge wire, printed **#904 BLOWER SWITCH POWER**, this wire will provide switched ignition power to the blower switch from the 30 amp “AC/HEAT” fuse. This wire will have power anytime the ignition switch is in the *ON/RUN* position. On 2 speed systems this would have been a tan or red/white wire.

Tan: 14 gauge wire, printed **#967 BLOWER MOTOR POWER**, this wire will provide power from the blower switch to the blower motor. This wire is doubled up with another tan wire, see below. This wire is not needed on 2 speed systems.

Tan: 14 gauge wire, printed **#976 BLOWER MOTOR CONTROL/HIGH**, this wire will provide power from the blower resistor to the blower motor. On 2 speed systems, this wire will provide power to the high side of the motor, and would have been an orange wire from the factory.

Brown/White: 16 gauge wire, printed **#974 BLOWER MEDIUM**, this wire provides power from the blower switch to the blower resistor. This wire is not needed on 2 speed systems.

Brown: 16 gauge wire, printed **#975 BLOWER LOW**, this wire provides power from the blower switch to the blower resistor. On 2 speed systems, this wire will provide power to the low side of the motor, this would have been a red wire from the factory.

3 Speed Systems

- Route and connect the pre-installed connector to the heater switch as shown in the picture below.

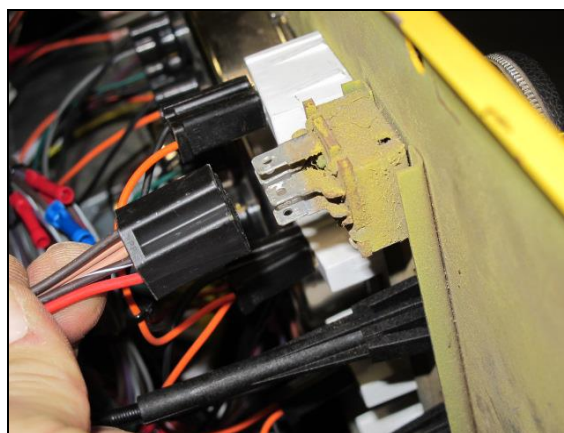

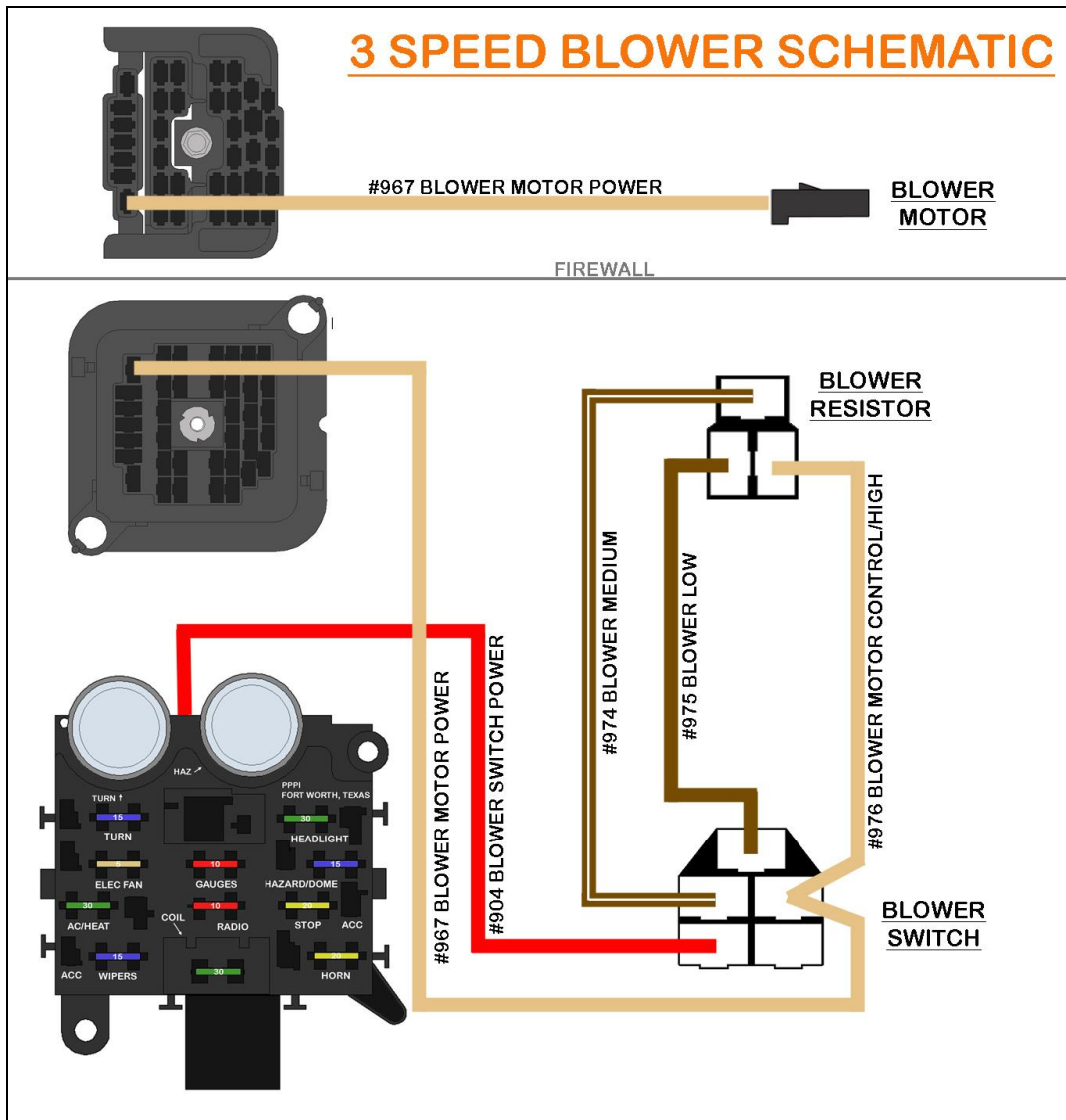

2 Speed Systems

- Cut the blower switch connector from the Painless Harness, **cut as close to the connector as possible**. Strip $\frac{1}{4}$ " of insulation from the red **#904** wire and install a light blue insulated terminal.
- Connect the red **#904** wire to the center prong on the blower switch.
- If you have existing wires coming from the blower motor, located on the passenger side interior firewall, connect these wires to the blower switch. These should be orange and red wires with a connector pre-installed.



The **#967** which provides power to the 3 speed blower motor will not be needed. Also, wires **#974**, **#975**, and **#976** wires will not be needed. These wires all go to the blower resistor connector, as seen in the schematic on the previous page. These wires are not connected to any power source, so insulating the unused ends will not be necessary if they are not removed from the harness.

2 SPEED BLOWER SCHEMATIC WITH "FACTORY" BLOWER MOTOR WIRES

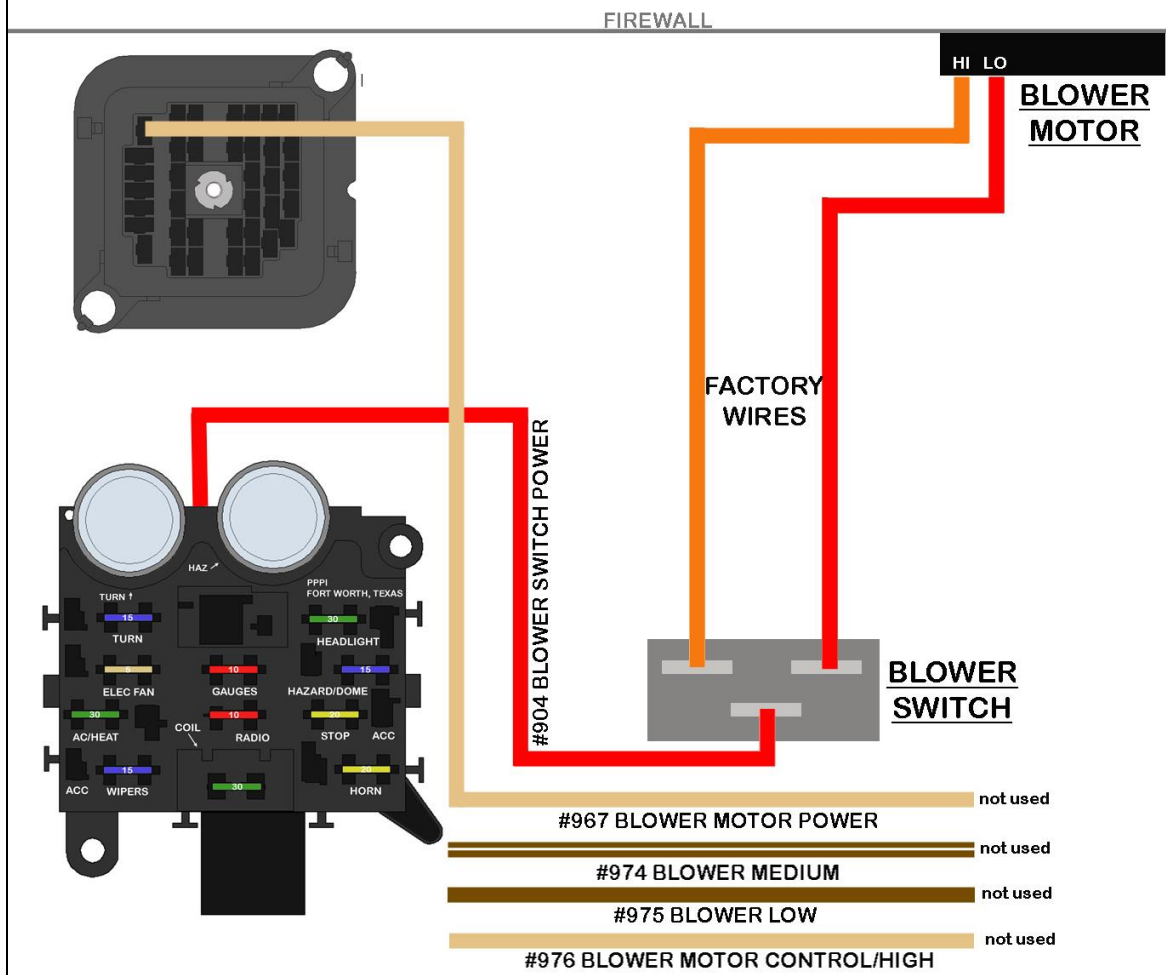

If you do not have wires on the blower motor, wires **#975** and **#976** will be used for blower motor connections. Strip $\frac{1}{4}$ " of insulation from these wires and install a light blue insulated terminal. Connect each wire to the two remaining tabs on the blower switch. Connection to the blower motor will be made later in the manual, page 82. The **#967** and **#974** will not be needed. These wires are not connected to any power source, so insulating the unused ends will not be necessary if they are not removed from the harness.

2 SPEED BLOWER SCHEMATIC NO "FACTORY" BLOWER MOTOR WIRES

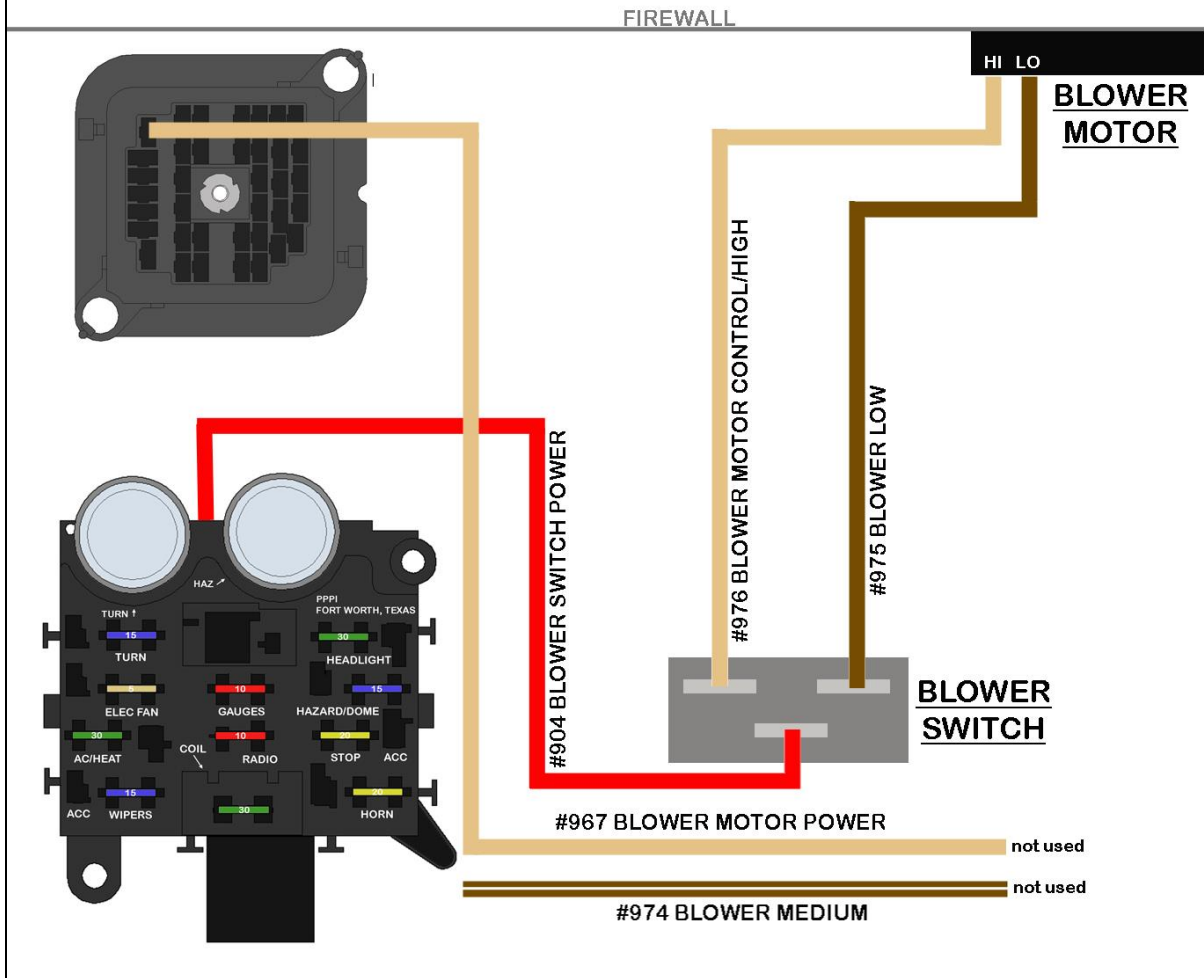

Factory Tachometer

The next connection on some dashes is the factory tachometer. There is not a section of the Painless harness dedicated to a factory tach, however all provisions to make connections to a factory tachometer are built into this harness, as mentioned in the Ignition Switch section on page 25. Proper instructions for factory as well as aftermarket tachs can be found on page 68.

"Dash Label Lights"

The next connection will be a chain of single pin connectors with black and orange wires. These are to provide power and ground to the label lights for defrost, air, temp and blower switch. These wires are:

Orange: 18 gauge wires, not printed, these wires are part of the #930 panel light circuit through a series of splices. These wires will have power anytime the headlight switch is in the Park/Tail Lights ON or Headlights On position. These wires can be seen in the [Panel Light Schematic](#) on page 44.

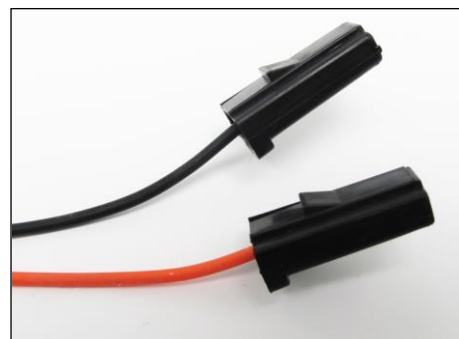

Black: 18 gauge wires, not printed, these wires are part of the #969 integrated ground distribution supplied throughout the harness and is tied directly back to the negative side of the battery. This will supply a clean ground source to the label lights. These wires can be seen in the [Ground Schematic](#) on page 14.

- Starting at the bottom closest to the main harness, connect the two black single pin connectors to the tabs of the dash label light, it does not matter which connector goes where on the light, only that it receives power to one side and ground to the other. Once connected move up to the next light and so on until all four have each had an orange wire and black wire connected.

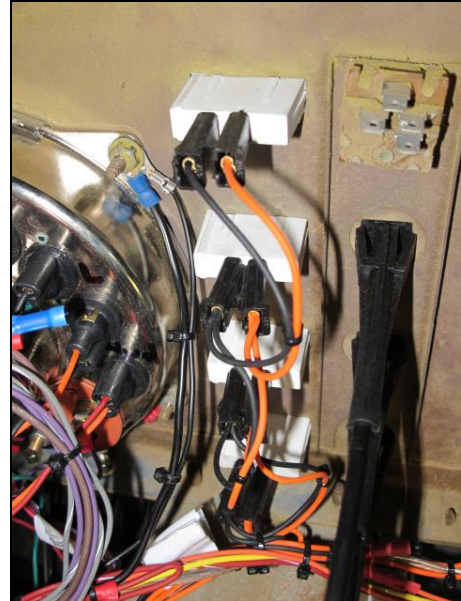

NOTES:

“Speedo/Cluster”



The speedometer/cluster connection will have multiple light sockets and wires with small ring terminals pre-installed. These connections will allow for proper connections to the factory/aftermarket gauge cluster. The wires in this section can all be seen in the [Cluster Schematic](#) and [Cluster Power Schematic](#) on pages 61 & 62. These wires include:

3 Panel Lamp Sockets:

Orange: 18 gauge wires, printed **#930 PANEL LIGHT POWER**, these wires are part of the **#930** panel light circuit through a series of splices. These wires will have power anytime the headlight switch is in the Park/Tail Lights ON or Headlights On position. These wires can be seen in the [Panel Light Schematic](#) on page 44.

Black: 18 gauge wires, not printed, these wires are part of the integrated ground distribution supplied throughout the harness and is tied directly back to the negative side of the battery. This will supply a clean ground source to the label lights. These wires can be seen in the [Ground Schematic](#) on page 14.

High Beam Indicator Light Socket

Gray/Black: 18 gauge wire, printed **#936 HIGH BEAM INDICATOR POWER**, this wire will provide a power activation source to the high beam indicator light. The other end of this wire is doubled up with the high beam wire at the interior bulkhead. This wire will have power anytime the headlight switch is in the *Headlights ON* position and the dimmer switch in the *HIGH BEAM* position. This wire can be seen in the [Headlight Switch Schematic](#) on page 43.

Black: 18 gauge wires, not printed, these wires are part of the integrated ground distribution supplied throughout the harness and is tied directly back to the negative side of the battery. This will supply a clean ground source to the high beam indicator. These wires can be seen in the [Ground Schematic](#) on page 14.

2 Turn Signal Indicator Sockets

Green/Black: 18 gauge wire, printed **#937 LEFT TURN INDICATOR POWER**, this wire is a power activation wire for the left turn signal indicator. This wire will have interrupted switched ignition power, through the turn flasher, anytime the left turn signal is activated. It will also have interrupted switched battery power, through the hazard flasher, anytime the hazard switch is activated. This wire can also be seen in the [Turn Signal Switch Schematic](#) on page 33.

Black: 18 gauge wires, not printed, these wires are part of the integrated ground distribution supplied throughout the harness and is tied directly back to the negative side of the battery. This will supply a clean ground source to the left turn indicator. These wires can be seen in the [Ground Schematic](#) on page 14.

Green: 18 gauge wire, printed **#938 RIGHT TURN INDICATOR POWER**, this wire is a power activation wire for the right turn signal indicator. This wire will have interrupted switched ignition power, through the turn flasher, anytime the right turn signal is activated. It will also have interrupted switched battery power, through the hazard flasher, anytime the hazard switch is activated. This wire can also be seen in the [Turn Signal Switch Schematic](#) on page 33.

Black: 18 gauge wires, not printed, these wires are part of the integrated ground distribution supplied throughout the harness and is tied directly back to the negative side of the battery. This will supply a clean ground source to the right turn indicator. These wires can be seen in the [Ground Schematic](#) on page 14.

Brake Warning Light Socket

Red: 18 gauge wire, not printed, this wire is a switched ignition power wire for the warning light. This wire receives power from the 10 amp “GAUGES” fuse and is spliced to other gauge power wires.

Black: 18 gauge wire, printed **#968 BRAKE WARNING SIGNAL**, this wire is a ground source to the brake warning light, causing it to illuminate. This ground signal will come from the low brake switch in the engine compartment and from the parking brake switch.

Four Wheel Drive Indicator Light Socket

Red: 18 gauge wire, not printed, this wire is a switched ignition power wire for the warning light. This wire receives power from the 10 amp “GAUGES” fuse and is spliced to other gauge power wires.

Orange: 18 gauge wire, printed **#984 QUADRA TRAC. LIGHT SIGNAL**, this wire is a ground source to the four wheel drive indicator, causing it to illuminate. This ground signal will come from the four wheel drive switch on the transfer case.

Fuel& Temp Gauge Connections

Red: 18 gauge wire, printed **#935 FUEL/TEMP GAUGE POWER**, this wire will supply switched ignition power from the 10 amp “GAUGES” fuse to the “I” terminal on the fuel gauge. The factory jumper from the A terminal of the fuel gauge to the “A” terminal of the temp gauge will provide power to the temp gauge.

Pink: 18 gauge wire, printed **#939 FUEL LEVEL SIGNAL**, this wire provides a resisted ground signal to the “S” terminal of the fuel gauge. The resistance on this wire comes from the fuel level sending unit in the fuel tank.

Purple/White: 18 gauge wire, printed **#921 ENGINE TEMP SIGNAL**, this wire provides a resisted ground signal to the “S” terminal of the temp gauge. The resistance on this wire comes from the temperature sending unit on the engine.

Black: 18 gauge wire, printed **#969 CLUSTER GROUND**, this wire is part of the integrated ground distribution supplied throughout the harness and is tied directly back to the negative side of the battery. This will supply a clean ground source to the gauge cluster. This wire can be seen in the [Ground Schematic](#) on page 14.

If a factory/aftermarket cluster isn't being used, and is being replaced with aftermarket individual gauges, like those manufactured by Autometer, see page 63.

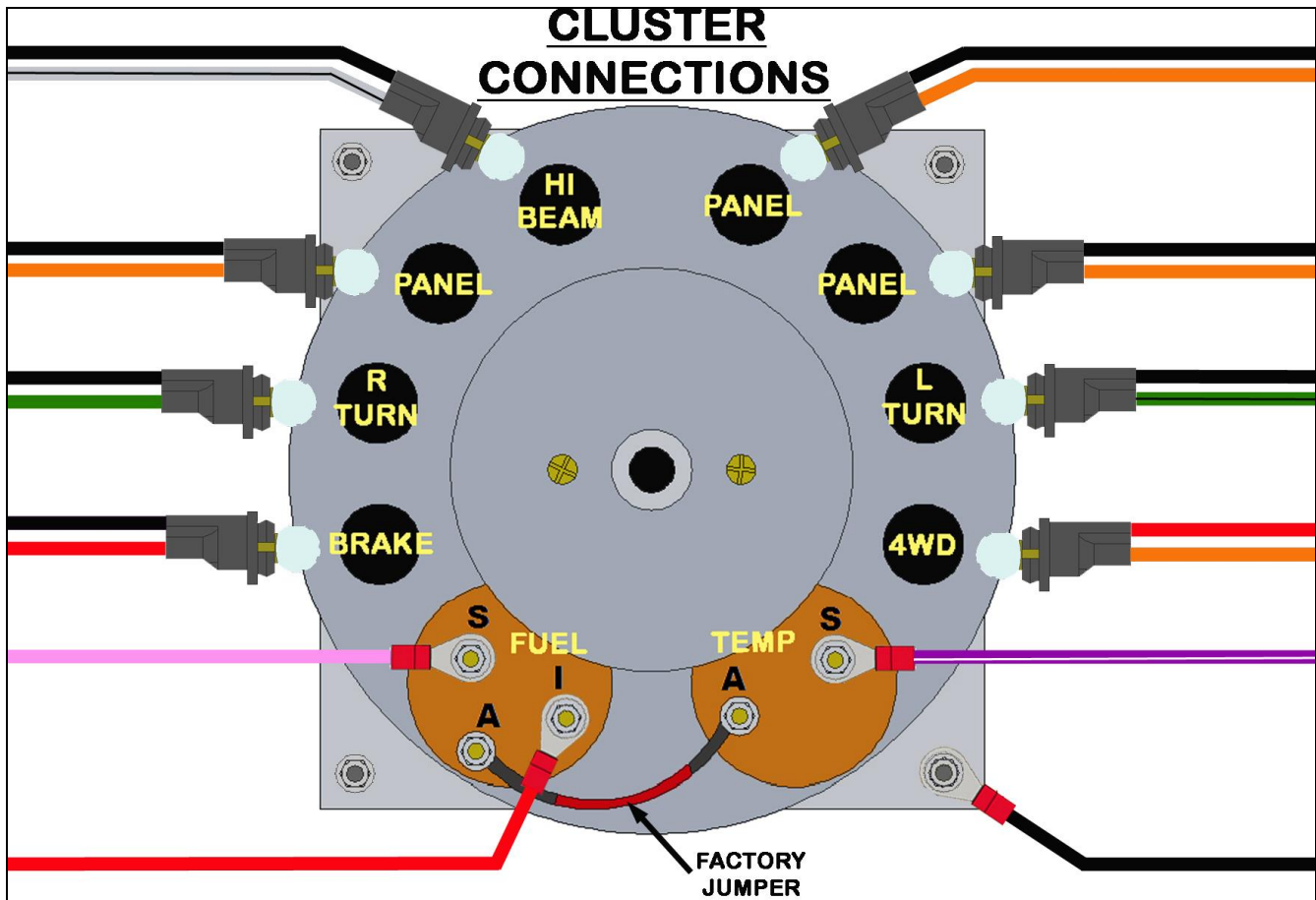

FACTORY & AFTERMARKET “FACTORY” GAUGE CLUSTERS

- Insert bulbs into each of the turn indicator sockets and into the four wheel drive and brake warning indicators. Depending on your cluster being factory or aftermarket, your cluster may require only two or all three of the panel lights supplied in this Painless harness. Insert bulbs into the panel light sockets that will be used. Push the light sockets into their proper hole, the correct locations can be seen in the diagram above.

Small #10-32 nuts and star washers have been provided in the parts kit to allow the following connections.

- Connect the red **#935** power wire to the “I” post on the fuel gauge. *A regulated jumper, not provided with the harness, should be installed between pin “A” on the fuel gauge and pin “A” on the temp gauge, as seen in the diagram on the previous page. This jumper will regulate the 12v power supplied by the **#935** wire to 5 volts the factory temperature gauge requires.

***DO NOT APPLY THE #935 WIRE DIRECTLY TO THE “A” POST OF A FACTORY TEMPERATURE GAUGE, IT WILL RUIN THE GAUGE.**

- Connect the pink **#939** fuel level wire to the “S” post on the fuel level gauge.
- Connect the purple/white **#921** engine temp wire to “S” posts on the temperature gauge.
- Connect the black **#969** ground wire to one of the cluster mounting bolts. This will provide a clean ground source to the cluster.

“Voltmeter”

Connections for the voltmeter consist of a light socket and two wires with ring terminals pre-installed. Small #10-32 nuts and star washers have been provided in the parts kit for connecting the ring terminals to threaded posts. These connections will provide power and ground for the back lighting of the gauge and also power and ground for gauge function. These wires are:

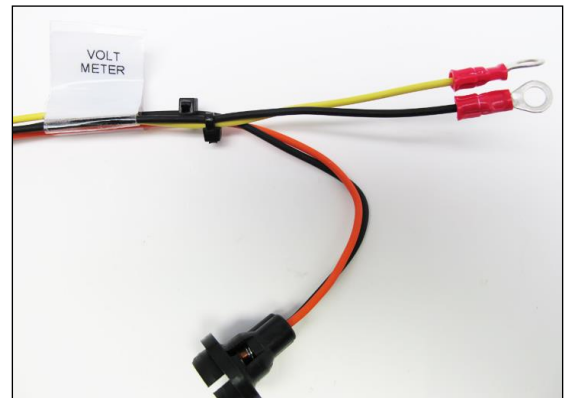

Orange: 18 gauge wire, printed **#930 VOLTMETER LIGHT POWER**, this wire is part of the **#930** panel light circuit through a series of splices. This wire will have power anytime the headlight switch is in the Park/Tail Lights ON or Headlights On position. This wire can be seen in the [Panel Light Schematic](#) on page 33.

Black: 18 gauge wire, printed **#969 VOLTMETER LIGHT GROUND**, this wire is part of the integrated ground distribution supplied throughout the harness and is tied directly back to the negative side of the battery. This will supply a clean ground source to the voltmeter light. This wire can be seen in the [Ground Schematic](#) on page 14.

Yellow: 18 gauge wire, printed **#935 VOLTMETER POWER**, this wire will supply switched ignition power from the 10 amp “GAUGES” fuse to the “I” or power terminal on the voltmeter. This wire can be seen in the [Cluster Power Schematic](#) on page 59.

Black: 18 gauge wire, printed **#969 VOLTMETER GROUND**, this wire is part of the integrated ground distribution supplied throughout the harness and is tied directly back to the negative side of the battery. This will supply a clean ground source to the voltmeter. This wire can be seen in the [Ground Schematic](#) on page 14.

- Install a bulb from the parts kit into the light socket and insert the socket into the hole in the back of the voltmeter.

If you are using a factory style aftermarket voltmeter, it may have a light socket with tabs pre-installed on the gauge. If the socket on this harness does not fit your gauge, or you want to use the socket that comes with the gauge, cut the light socket from the harness, strip ¼" insulation from the orange and black wires, and install insulated female terminals from the parts kit to connect the wires to the light socket provided with the gauge.

- Connect the yellow **#935** wire to the power, +, or "I" post of the voltmeter.

If you are replacing your factory voltmeter with a factory style aftermarket voltmeter, pay attention to which post is the power and which is ground, some are on opposite sides of the gauge compared to a factory gauge.

- Connect the black **#969 VOLTmeter GROUND** wire to the post labeled - or "GND". If you do not have a ground post, connect this wire to one of the mounting posts on the voltmeter. This will provide a clean ground source to the housing of the voltmeter.

Again, if you are replacing your factory voltmeter with a factory style aftermarket voltmeter, pay attention to which post is the power and which is ground, some are on opposite sides of the gauge compared to a factory gauge.

"Oil Gauge"

Connections for the oil pressure gauge consist of a light socket and three wires with ring terminals pre-installed. Small #10-32 nuts and star washers have been provided in the parts kit for connecting the ring terminals to threaded posts. These connections will provide power and ground for the back lighting of the gauge and also power, ground, and a resisted ground signal from the oil pressure sending unit on the engine for gauge function. These wires are:

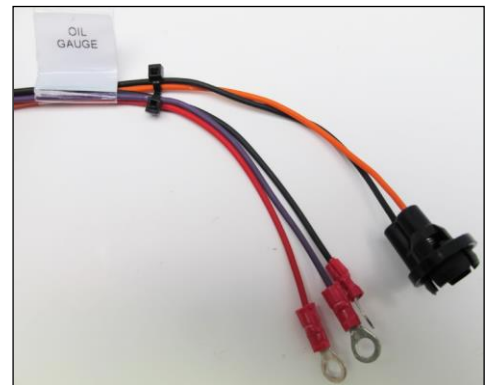

Orange: 18 gauge wire, printed **#930 OIL PRESS. GAUGE LIGHT POWER**, this wire is part of the **#930** panel light circuit through a series of splices. This wire will have power anytime the headlight switch is in the Park/Tail Lights ON or Headlights On position. This wire can be seen in the [Panel Light Schematic](#) on page 33.

Black: 18 gauge wire, printed **#969 OIL PRESS. GAUGE LIGHT GROUND**, this wire is part of the integrated ground distribution supplied throughout the harness and is tied directly back to the negative side of the battery. This will supply a clean ground source to the oil pressure gauge light. This wire can be seen in the [Ground Schematic](#) on page 14.

Red: 18 gauge wire, printed **#935 OIL PRESS. GAUGE POWER**, this wire will supply switched ignition power from the 10 amp "GAUGES" fuse to the "I" or power terminal on the oil pressure gauge. This wire can be seen in the [Cluster Power Schematic](#) on page 61.

Black: 18 gauge wire, printed **#969 OIL PRESS. GAUGE GROUND**, this wire is part of the integrated ground distribution supplied throughout the harness and is tied directly back to the negative side of the battery. This will supply a clean ground source to the oil pressure gauge. This wire can be seen in the [Ground Schematic](#) on page 14.

Purple: 18 gauge wire, printed **#922 OIL PRESSURE SIGNAL**, this wire will send a resisted ground signal from the oil pressure sending unit on the engine to the gauge. This wire can be seen in the [Cluster Schematic](#) on page 62.

- Install a bulb from the parts kit into the light socket and insert the socket into the hole in the back of the oil pressure gauge.

If you are using a factory style aftermarket oil pressure gauge, it may have a light socket with tabs pre-installed on the gauge. If the socket on this harness does not fit your gauge, or you want to use the socket that comes with the gauge, cut the light socket from the harness, strip ¼" insulation from the orange and black wires, and install insulated female terminals from the parts kit to connect the wires to the light socket provided with the gauge.

- Connect the red **#935** wire to the power or "I" post of the oil pressure gauge. On a factory gauge this post may not be marked however the ground post will be marked "GND" so the post without any marking or indication is the power post.

If you are replacing your factory gauge with a factory style aftermarket oil pressure gauge, pay attention to which post is the power and which is ground, some are on opposite sides of the gauge compared to a factory gauge.

- Connect the black **#969 OIL PRESS. GAUGE GROUND** wire to the post labeled "GND" or ground. If you do not have a ground post, connect this wire to one of the mounting posts on the oil pressure gauge. This will provide a clean ground source to the housing of the gauge.

Again, if you are replacing your factory voltmeter with a factory style aftermarket voltmeter, pay attention to which post is the power and which is ground, some are on opposite sides of the gauge compared to a factory gauge.

- Connect the purple **#922** wire to the sender/signal or "S" tab on the oil pressure gauge.

NOTES

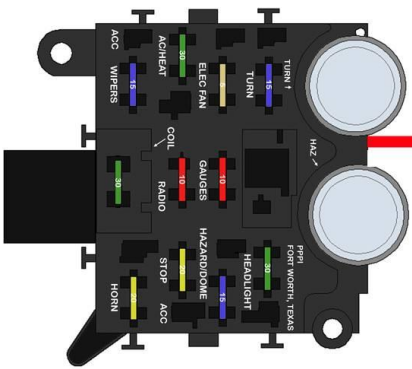

CLUSTER POWER SCHEMATIC

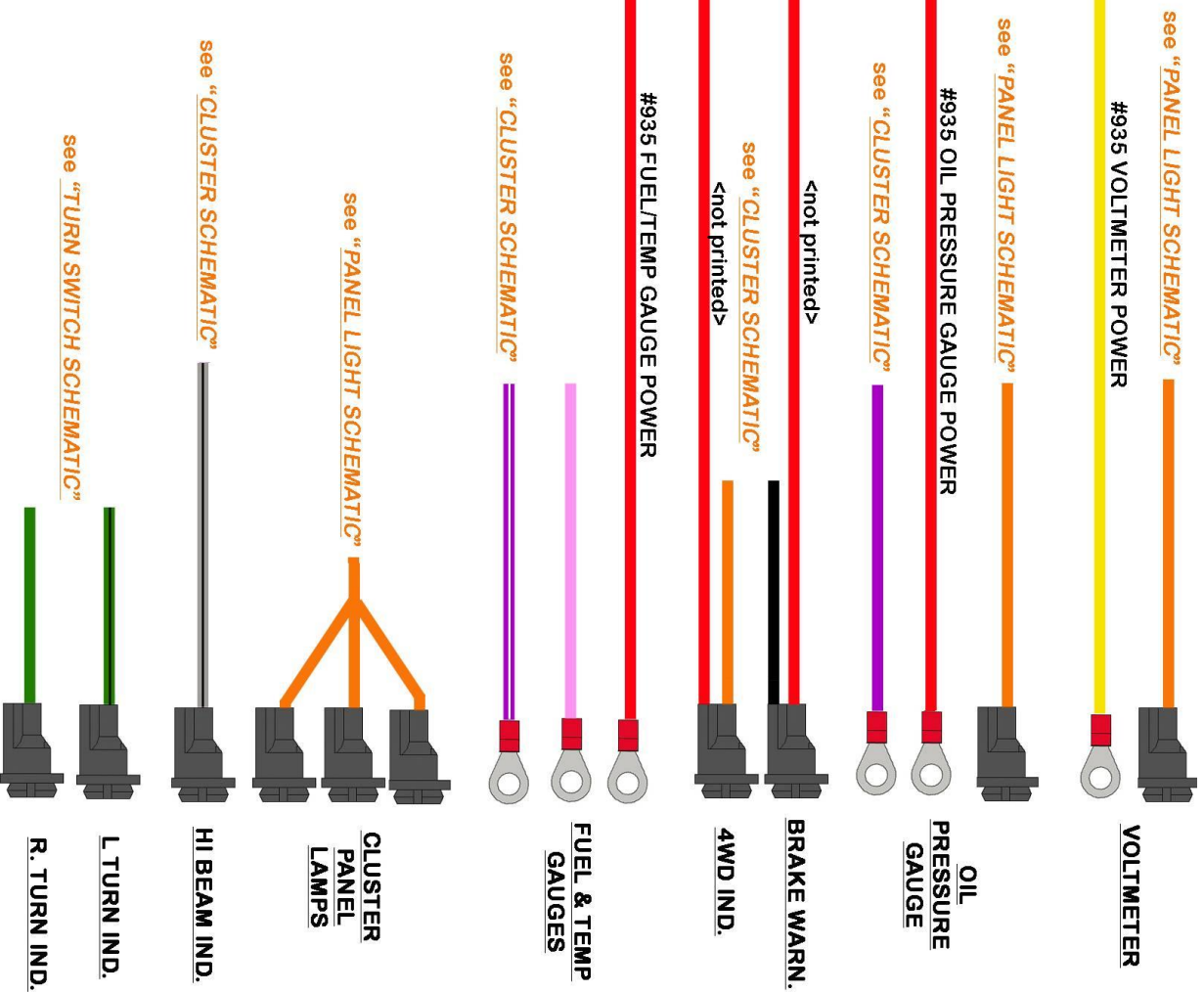

Aftermarket Gauges

The following set of instructions is for those completely replacing the factory gauge cluster, voltmeter, and oil pressure gauge with aftermarket gauges and will be universal in nature due to all the different manufacturers of aftermarket gauges. Use the following instructions along with the gauge manufacturer's instructions.

Most electric aftermarket gauges require five wire connections:

- Gauge Power- a Switched 12 volt power source
- Gauge Ground
- Signal- from a sensor or sending unit
- Gauge Light Power- 12 volt power source from the Gauge Lighting circuit
- Gauge Light Ground

Most mechanical aftermarket gauges only require two wires to be connected:

- Gauge Light Power- 12 volt power source from the Gauge Lighting circuit
- Gauge Light Ground

All of these connections are already present in the wiring for the factory instrument cluster and gauges. Additional length may need to be added to some wires, as the wires of the Painless harness have all been pre-cut according to the factory gauge cluster.

There are two methods to connecting aftermarket gauges, separate harness and hard wiring:

Separate harness:

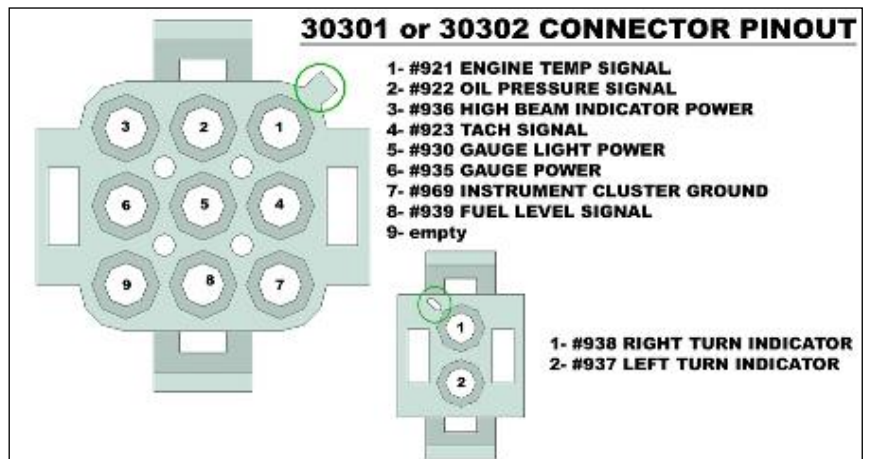
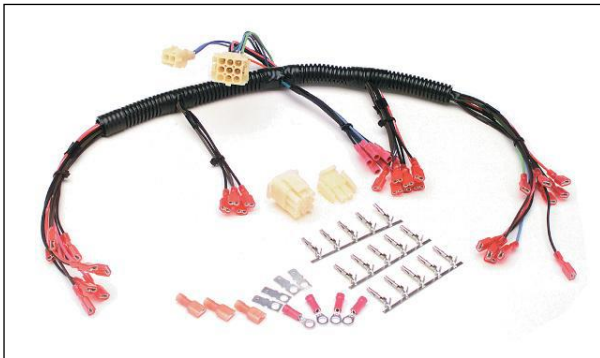

To facilitate wiring aftermarket gauges, Painless offers and recommends the use of [Painless part # 30301](#) (#30302 if using an electric speedometer). This will be a universal gauge cluster harness that has all the splicing and termination pre-installed for these types of applications. This harness will also offer you the benefit of having an inline connector instead of hardwiring the chassis harness directly to the gauges.

- Cut the pre-installed sockets and terminals from the instrument cluster wires.
- Using the terminals and connector found in the 30301 or 30302 kit, install the wires of this chassis harness according to the diagram above. Use the numbers on the connectors as well as the circled reference points in the diagram for proper cavity location.

Hard Wiring:

Those choosing to wire aftermarket gauges with just the wires found in the Painless chassis harness, and not purchasing an additional gauge harness, the following steps will walk you through the process of distributing power and ground, as well as connecting the sender wires. The following diagrams only show temp, oil pressure, volt and fuel level gauges. Power, ground and sender wires will connect in the same manner to speedometers and tachometers.

Power to the gauges will need to come from the red **#935 FUEL/TEMP GAUGE POWER** wires and/or the yellow **#935 VOLTMETER POWER** wire which can be found farther down the harness. Power will need to be connected to the "1" or "12v" post on the gauge. The power wire can be connected in one of two ways:

#1) Splicing- Splice off one of the **#935** wires and running wires to several gauges and splicing off the other **#935** wire and running wires to the remaining gauges.

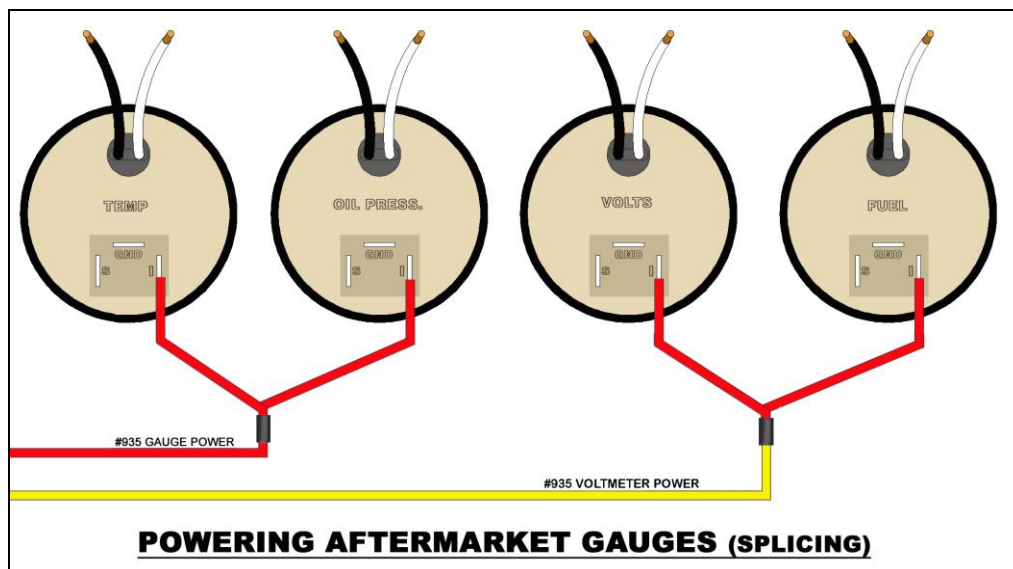

#2) Chaining or Jumpering- Run one of the **#935** wires to a power post, before terminating the wire with the proper terminal, you will insert another wire into the terminal and crimp. You will now have 2 wires in one terminal. This additional wire will then route to the power post on another gauge. Before terminating the wire with the proper terminal, you will insert another wire into the terminal; and so on.

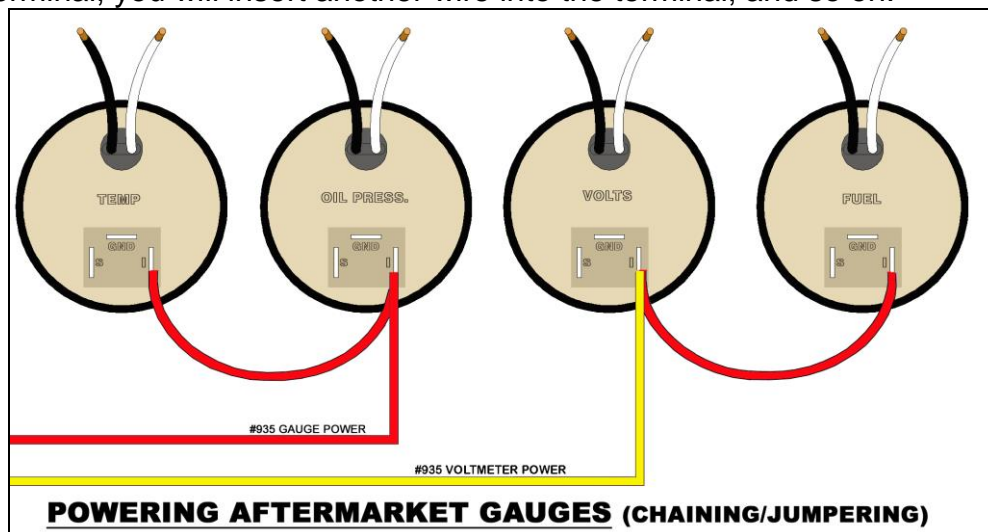

Grounds will need to be supplied to the gauge lights and to any ground tab on the gauges. These grounds can come from the black **#969 CLUSTER GROUND** wire and/or seeing that a good ground source is not hard to find on these vehicles, the installer could run their own ground circuit for gauge connections. To make these ground connections you can splice from this **#969** wire to all the gauges or chain/jumper it all together. Both methods are seen in the following two drawings:

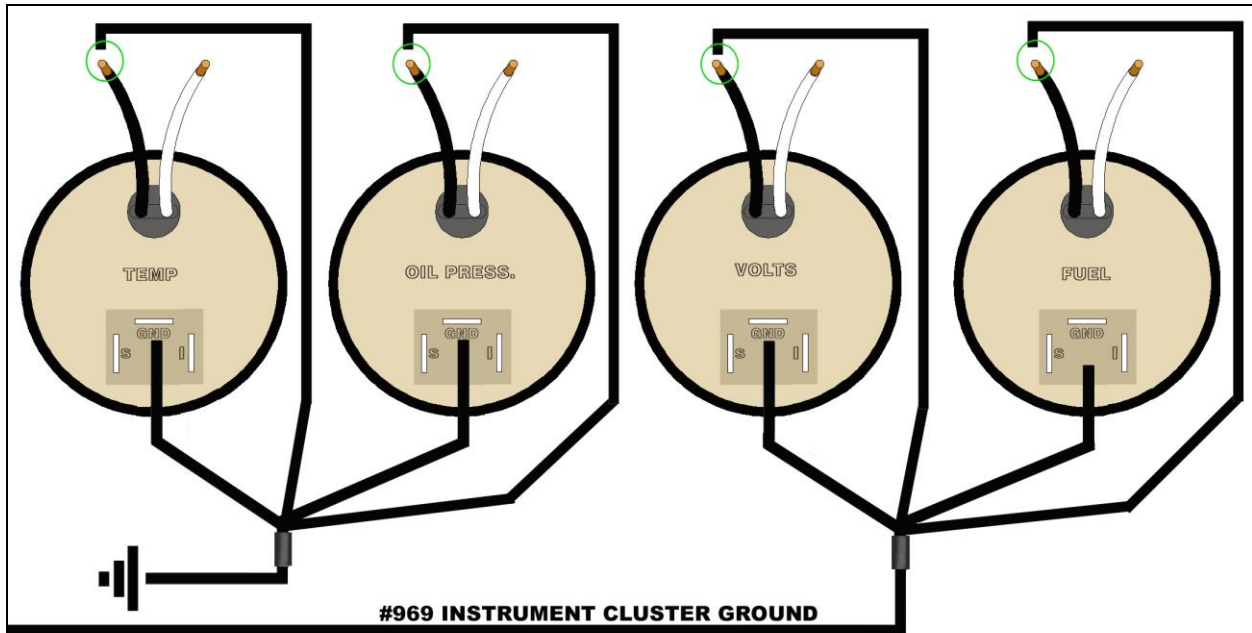

GROUNDING AFTERMARKET GAUGES (SPLICING)

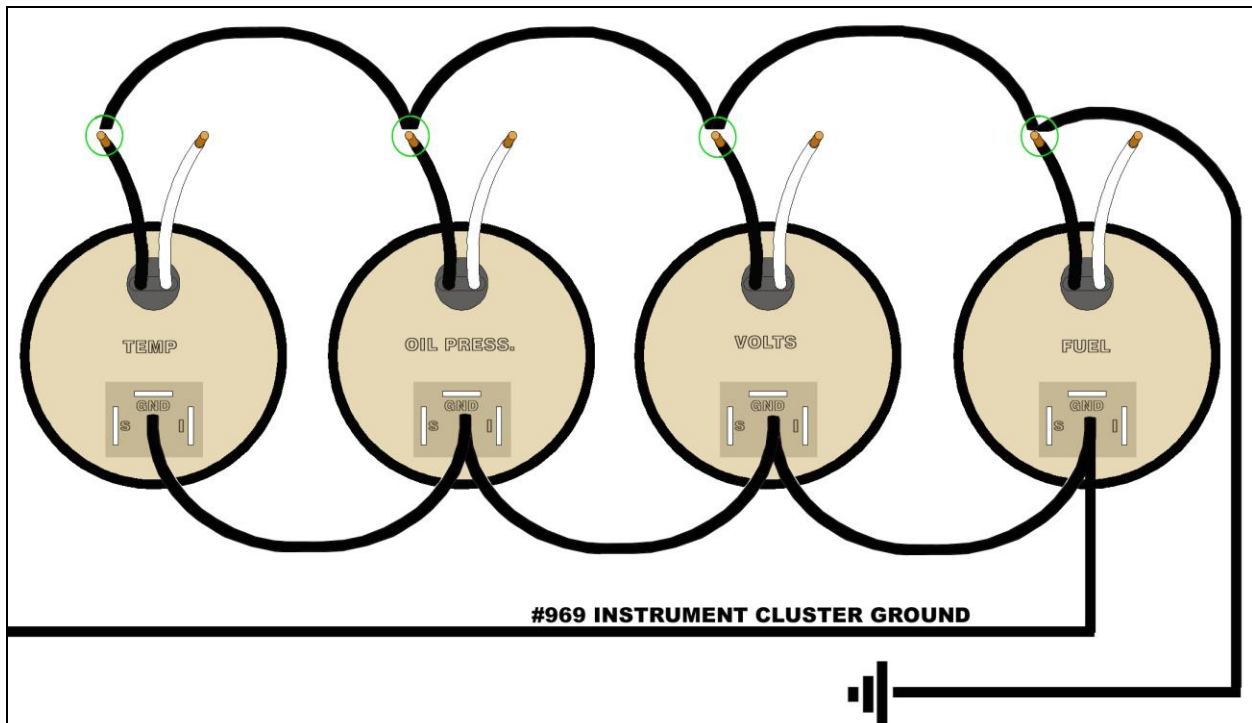

GROUNDING AFTERMARKET GAUGES (CHAINING/JUMPERING)

Gauge light power will be supported by the orange **#930 PANEL LIGHT POWER** wires. These wires will connect to one of the leads for the gauge light, or to the gauge light tab labeled "light +12v" on gauges with LED backlighting. To make these connections you can splice from this **#930** wire to all the gauges or chain/jumper it all together.

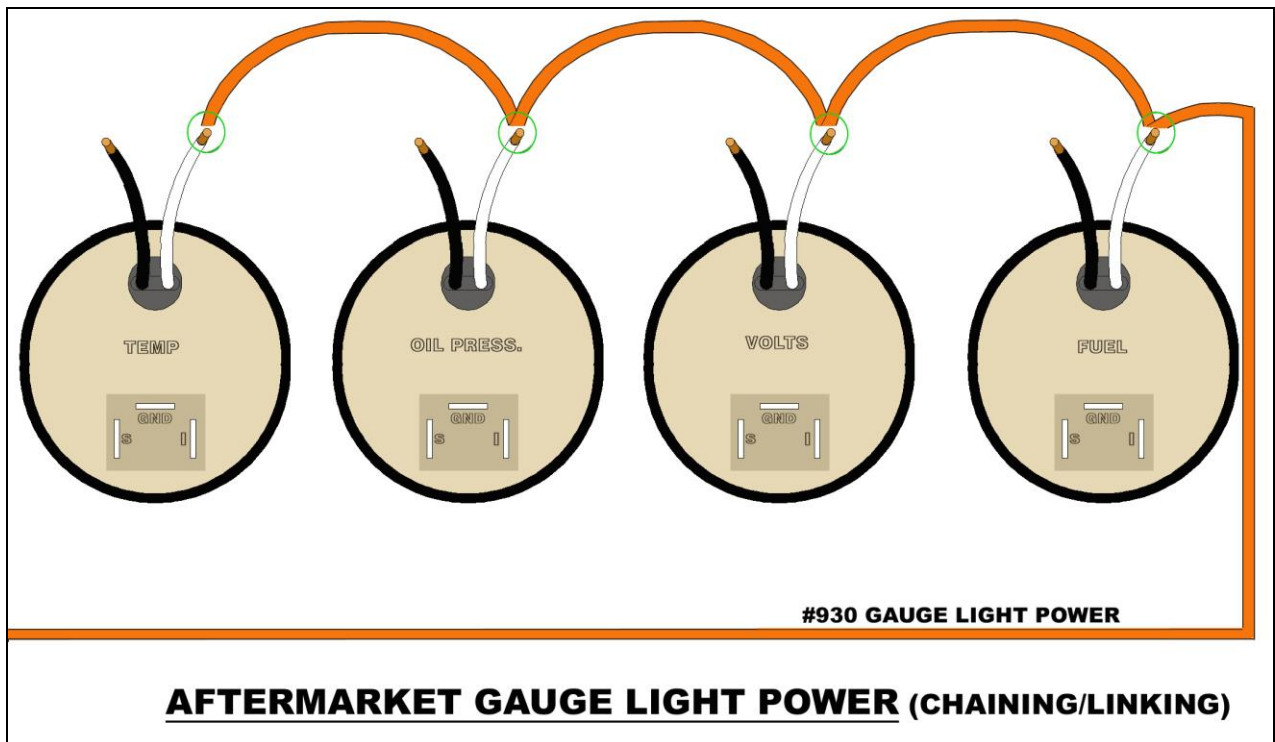
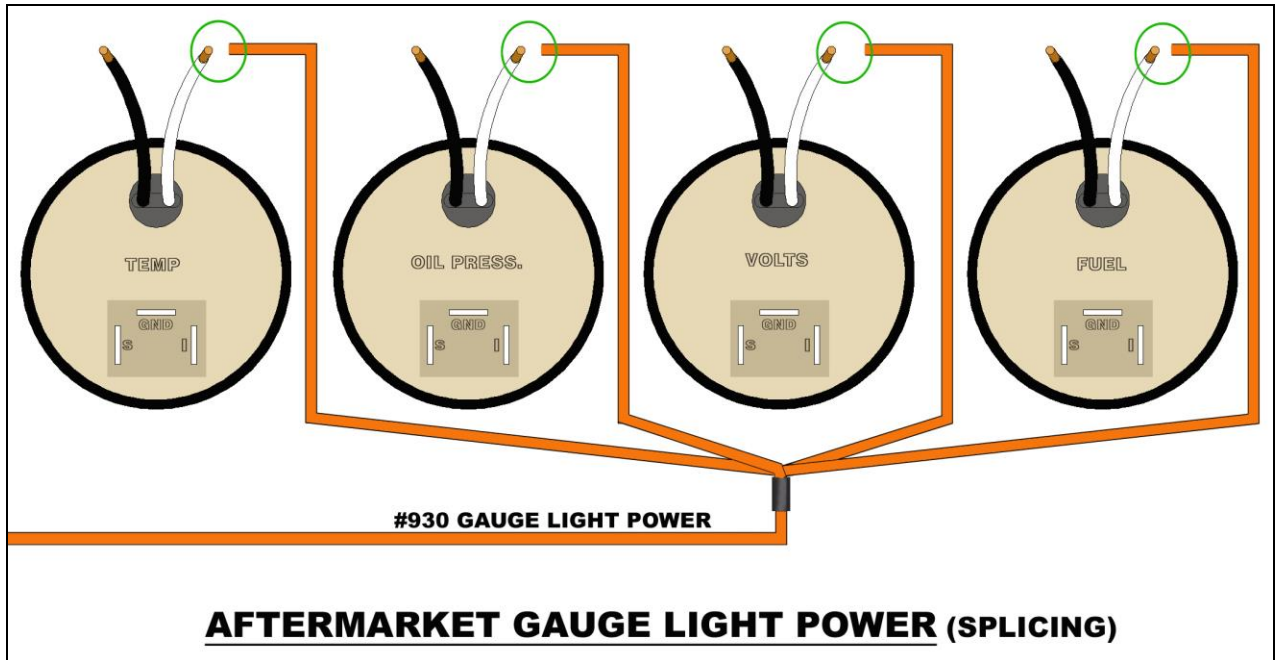

The last connection needing to be made will be the sending unit wires or signal wires. These will be the wires which come from the temperature sending unit, oil pressure sending unit, and fuel level sending unit. Not shown in the diagram, but also provided in the Painless chassis harness is the purple **#923 TACHOMETER SIGNAL** wire.

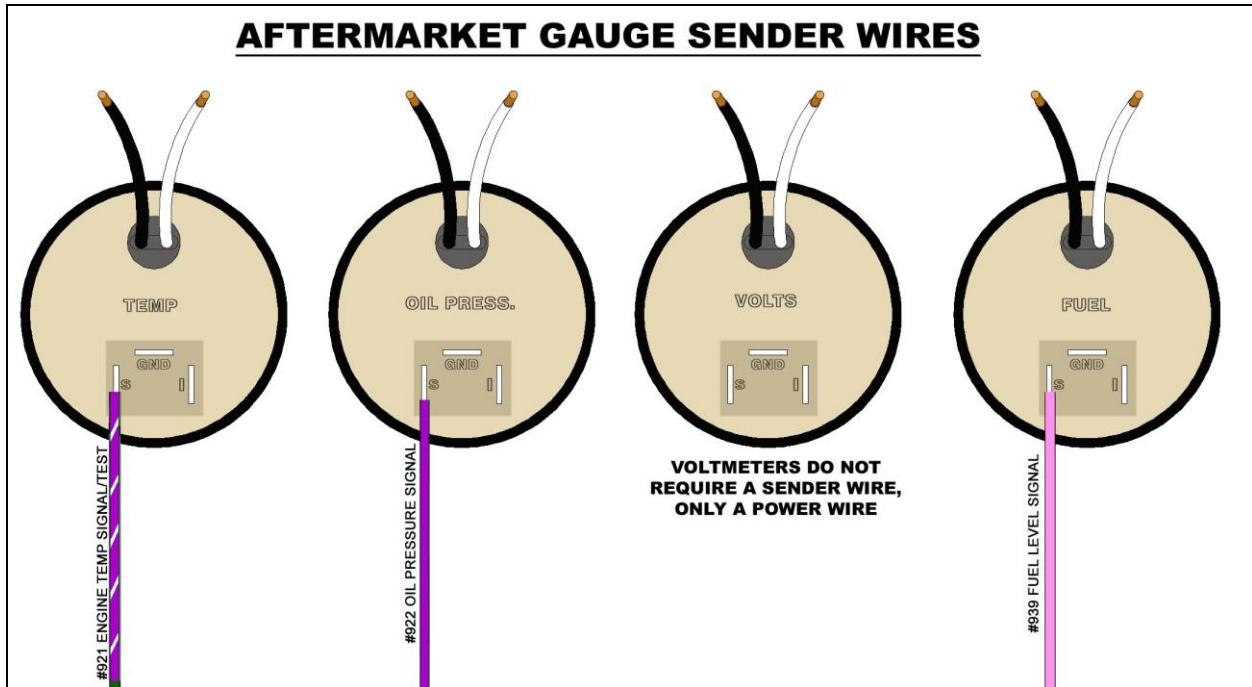

NOTES:

“Tach”

The next connection is an optional equipment connection, meaning not all installs will require the use of this connection. The “TACH” section will have four wires needed for proper connections to aftermarket tachometers, as well as factory tachometers. These four wires are:

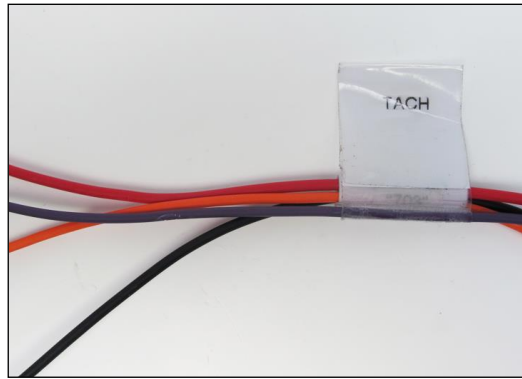

Orange: 18 gauge wire, printed **#930 TACHOMETER BACKLIGHT POWER**, this wire is part of the #930 panel light circuit through a series of splices. This wire will have power anytime the headlight switch is in the Park/Tail Lights ON or Headlights On position. This wire can be seen in the [Panel Light Schematic](#) on page 33.

Red: 18 gauge wire, printed **#935 TACHOMETER POWER**, this wire will supply switched ignition power from the 10 amp “GAUGES” fuse to the “I” or power terminal/wire on the tachometer.

Black: 18 gauge wire, printed **#969 TACH BACKLIGHT GROUND**, this wire is part of the integrated ground distribution supplied throughout the harness and is tied directly back to the negative side of the battery. This will supply a clean ground source to the backlighting of the tach. This wire can be seen in the [Ground Schematic](#) on page 14.

Purple: 18 gauge wire, printed **#923 TACHOMETER SIGNAL**, this wire will send a ground signal from the negative side of the coil or ignition box to the “S” or signal terminal/wire on the tach.

Connections of any or all of these wires will depend on what type of tachometer your particular install is using.

- If no tach is being used, insulate the ends of the orange **#930** and red **#935** wires, **these wires are power wires and will short to ground if left un terminated**. The **#930**, **#935**, and black **#969** wires can also be used to provide power and ground to additional aftermarket gauges.

Connections to the tach can be done with insulated terminals from the parts kit, Painless recommends using the male/female disconnect terminals to allow the tach to be removed from the chassis harness if the need ever arises.

Those using a factory tach will notice an orange wire with a connector pre-installed, in most cases a green connector, coming from the tach. A mating connector and terminal have been provided in the parts kit that will allow an easy connection of the **#930** wire to this orange wire on the tach. A pair of roll over crimpers, seen on page 8, will be needed to properly crimp this terminal.



Aftermarket Tachometer

Aftermarket tachometers, like universal ones sold by companies like Autometer, or aftermarket replicas of a factory CJ tachometer will generally require all four wires to be connected. These connections will either be to terminals on the back of the tachometer or in most cases to wires pre-wired to the tach. Consult the manufacturer's instructions for each terminal/wires function. Most pre-wired tachometers follow a common color code:

Red = power, **Green**= tach. signal, **White**= backlight power, **Black**= backlight ground

- Connect the red **#935** wire to the "I" or power terminal/wire on the tachometer.
- Connect the purple **#923** wire to the "S" or signal terminal/wire on the tachometer.
- Connect the orange **#930** wire to the "LIGHT+" or light power terminal/wire on the tachometer.
- Connect the black **#969** wire to the "LIGHT GND" or light ground terminal/wire on the tachometer.
- Follow the manufactures' instructions for proper cylinder selection to match the engine you are using. Universal tachs may have wire loops that need to be cut, whereas most aftermarket replica CJ tachs will have switches on the back.

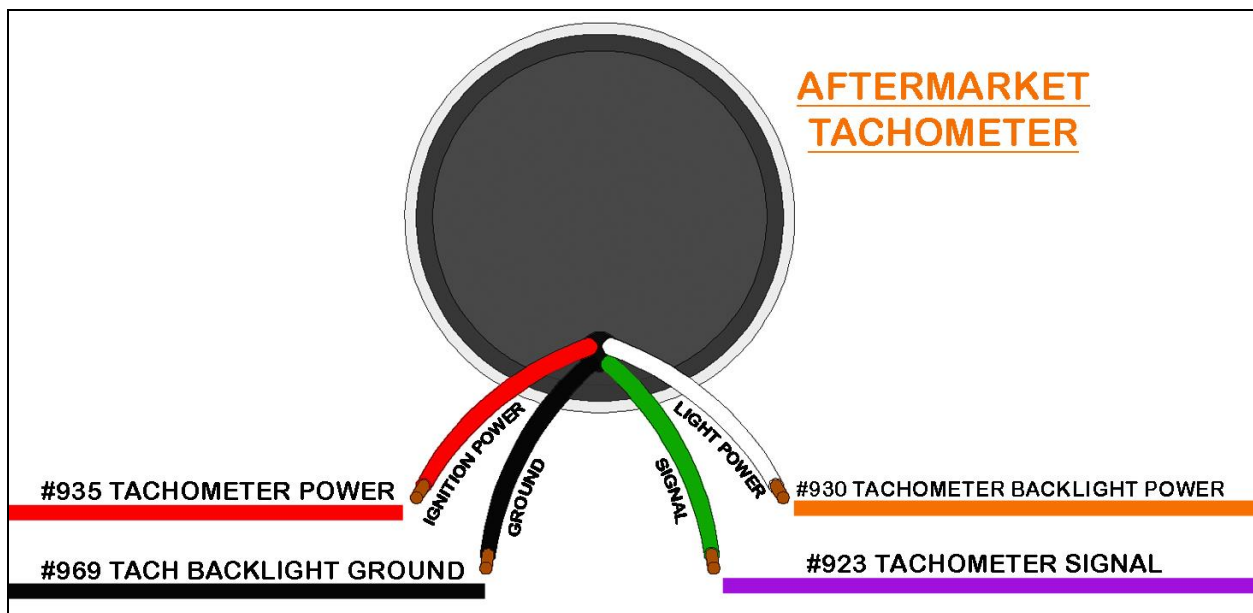

NOTES:

Factory 4 Cylinder Tachometer

Factory tachometers used on 4 cylinder engines will have five wires coming from the rear of the tach. The factory tach had a 3 pin connector pre-installed on the tach, this connector will need to be removed from the wires on the tach, and insulated terminals from the parts kit used to make connections to the Painless harness. Use the following instructions to connect the Painless harness to a factory 4 cylinder tachometer.

- Connect the red **#935** wire to the red wire on the tachometer.
- Connect the purple **#923** wire to the white wire on the tachometer.
- Connect the black **#969** wire to the black wire on the tachometer. This will be the black wire on the tach and not the black wire with a ring terminal coming from the light socket. Ignore the "...BACKLIGHT GROUND" printed on this wire, it will now provide a ground source for the gauge.

If your tach does not have a ring terminal on the black wire from the socket, you can double up both black wires from the tach with the **#969** wire of the Painless harness.

- Connect the orange **#930** wire to the orange light power terminal/wire on the tachometer. A connector and terminal, seen in the photo, have been provided in the parts kit to fit the factory connector found on this wire.
- Connect the black wire with the ring terminal from the light socket of the tachometer to a chassis ground source.

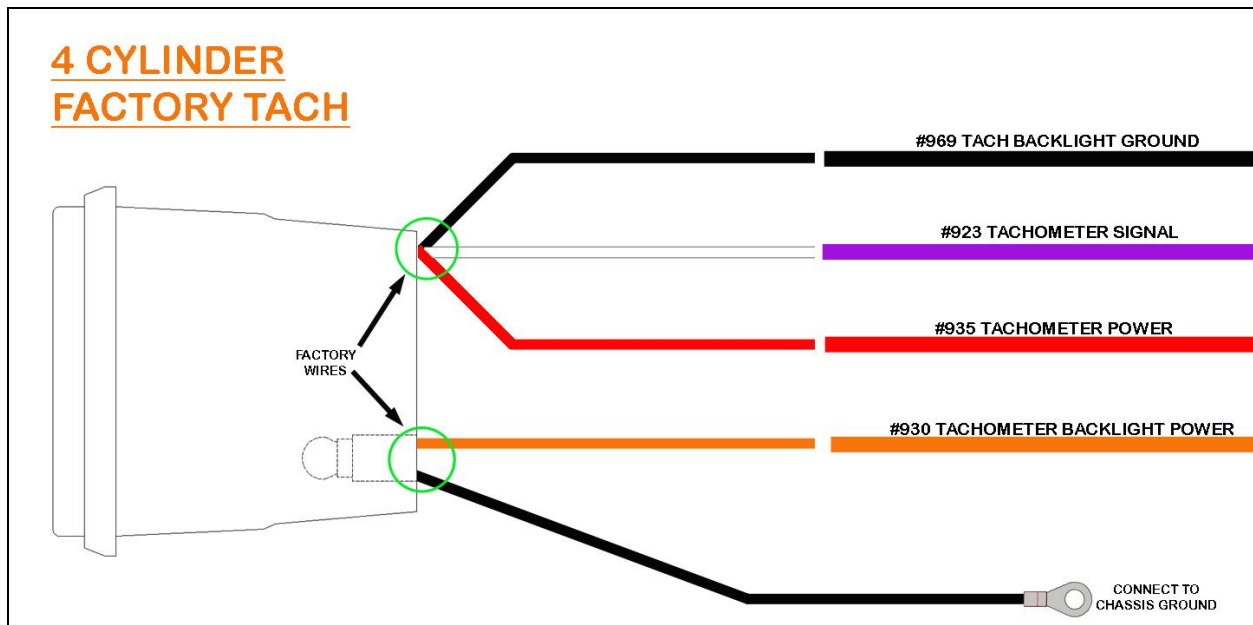

Factory 6 & 8 Cylinder Tachometer

Factory tachometers used on 6 & 8 cylinder engines will have 4 wires coming from the rear of the tach. Use the following instructions to connect the Painless harness to a factory 6/8 cylinder tachometer.

- The red **#935** and purple **#923** wires will not be used with these factory tachs. Insulate the end of #935 with an insulated terminal from the parts kit to keep it from shorting to ground.
- **#969** may or may not be used on your particular application based on how the ground for the light socket is connected, see below.
- Route the two red wires coming from the back of the tachometer to the ignition switch.
- At the ignition switch you will notice an inline connection on the red/white wire, this wire provides ignition switched power to the coil fuse and then out to the coil, unplug this inline connection.
- Plug the connectors on the wires from the tach into the two connectors on the Painless harness that were just disconnected.
- Connect the orange **#930** wire to the orange wire on the tachometer.
- Connect the black wire with the ring terminal from the light socket of the tachometer to a chassis ground source. If your tach does not have a ring terminal or if you want to utilize the integrated ground circuit provided by the harness, connect this black wire from the light socket to the black **#969** wire.

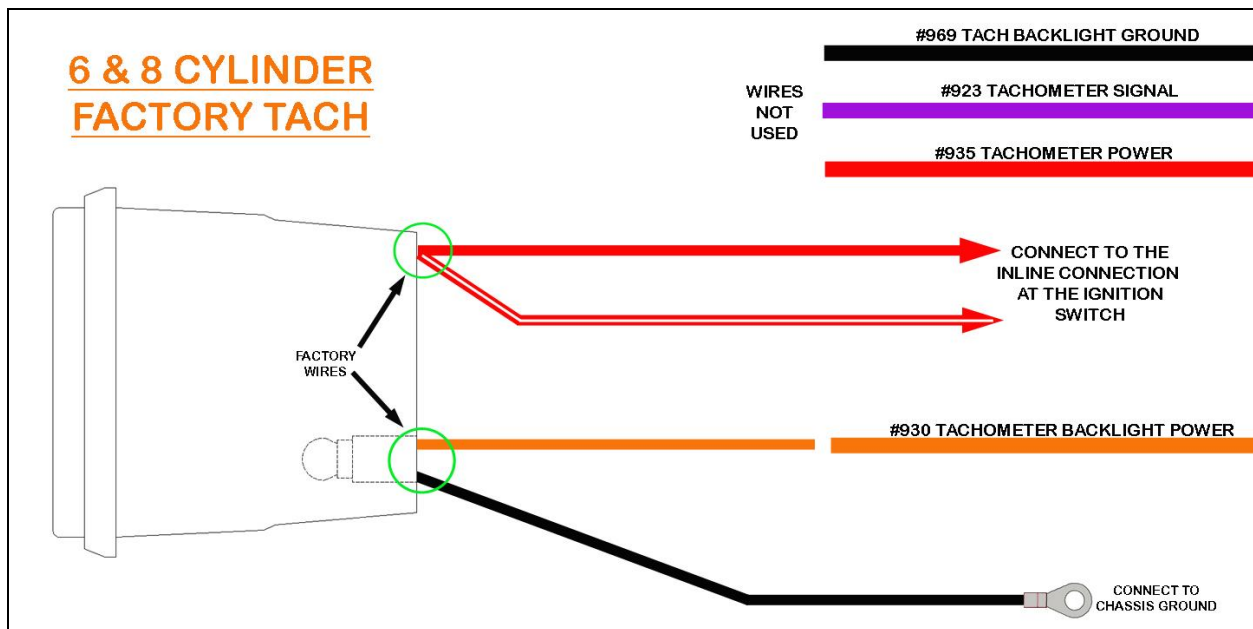

“Radio”

The radio connection on the Painless harness is set up for a universal application since most Jeeps no longer have the factory radio in place. The two power wire colors used by Painless reflect the colors most aftermarket companies’ use on radios manufactured today.



The Painless harness includes four wires dedicated for a connection to the radio. The wires can be identified by a section label reading “RADIO”. These four wires are:

Yellow: 16 gauge wire, printed **#940 RADIO BATTERY POWER**, this wire will provide the radio a battery power source that will allow the time and radio presets to remain every time the ignition is turned off. This wire comes from the 20 amp HORN fuse found towards the middle of the fuse block.

Red: 16 gauge wire, printed **#941 RADIO SWITCHED/IGN POWER**, this wire will provide the radio with ignition switched power for operation. This wire will have power when the ignition switch is in the ACCESSORY and ON/RUN positions. This wire comes from the 10 amp RADIO fuse on the center of the fuse block.

Black: 16 gauge wire, printed **#969 RADIO GROUND**, this wire will supply a ground source to the radio. This wire is part of the integrated ground circuit of the Painless harness. This wire can be seen in the [Ground Schematic](#) on page 14

Orange: 18 gauge wire, printed **#930 RADIO BACKLIGHT/DIM POWER**, this wire will provide a power signal to the radio to dim the back lighting/display during low light conditions. On older radios this power source will illuminate the backlighting. This **#930** is tied to the other **#930** wires coming from the headlight switch to things like the gauge lights, panel lights, and gear indicator light. This wire will have power anytime the headlight switch is in the Park/Tail Lights ON or Headlights On position. This wire can be seen in the [Panel Light Schematic](#) on page 33.

- If you are using an aftermarket radio, refer to the manufacturer’s installation guide for proper connection. Splices and quick disconnect terminals have been provided in the parts kit.

NOTES:

Those using a factory radio, please consult a factory wire schematic as different radios were used throughout production. In most cases the factory radio will not require a battery power source, yellow #940. Insulate this wire as it has constant battery power.

- Connect the orange wire from the radio to the orange #930, this will provide power to the backlight of the radio.
- Connect the brown or tan wire(s) on the radio to the red #941 wire, this will provide a switched power source to the radio.
- Connect the black wire on the radio to the black #969 wire, this will provide the radio with a clean ground source.



“ACC.”

The accessory section of this Painless harness contains wires which will provide power to a cigarette lighter/power port, power for electric fan relay activation or accessory component, and a wire that is intended to provide activation power out the A/C compressor on Jeeps with air conditioning. These wires are described in detail under the headings regarding their function on the following pages.

Cigarette Lighter/Power Port

In many applications, the cigarette lighter is more commonly used as a power port to charge cell phones and run other electronic components requiring a 12vDC power source.

The Cigarette Lighter/Power Port connection will be a single wire within the “ACC.” Section:

Red: 16 gauge wire, printed #903 CIGARETTE LIGHTER POWER, this wire will provide constant battery power. This wire comes from the 20 amp HORN fuse on the fuse block.

Universal aftermarket lighters/power ports, like universal lighter socket part #56458, can be found at most local parts store. This lighter will replace a broken factory lighter or can be installed into the dash if your CJ never had a lighter/power port. Insulated bullet/socket/spade style terminals have been provided in the parts kit to allow proper connections to this type of socket.

- Route the **#903** wire to the cigarette lighter/power port.
- Cut the wire to length and connect.
- If the lighter is in a plastic housing, such as the factory used, the lighter/power port socket will require a ground wire, not provided, to be connected. This can be easily done by using a piece of scrap wire from a previous connection.



Relay Activation/Accessory Power

Two wires are supplied in the “ACC” section to allow power to be sent to an engine bay mounted relay for such things as a cooling fan relay or driving light relay(s). Please be aware these wires are only intended to energize the solenoid of a relay and **will NOT power** a cooling fan or driving lights directly. These two wires are:

Gray/White: 16 gauge wire, printed **#906 ACC. SWITCH/ACCESSORY IGNITION POWER**, this wire will provide power from the 5 amp ELEC FAN fuse on the fuse block to an accessory requiring a switched ignition 12v power source. This wire can also be used to power an activation toggle/rocker switch for cooling fan or driving light relay(s).

Gray/White: 16 gauge wire, printed **#901 ACC. SWITCH OUTPUT**, this wire will provide power from the **#906** wire, mentioned above, through the bulkhead out into the engine harness to the “ACC RELAY” section.

There are numerous ways these two wires can be used and connected. If an accessory is to be powered or an accessory relay, like a cooling fan or driving light relay, is to be installed choose the best option connection method according to the instructions and diagrams that follow.

If there is no need for an extra switched ignition power source at this time, simply insulate the **#906** wire with an insulated terminal from the parts kit. **#901** can remain open ended.

NOTES:

Powering a component

If you are powering a component directly, such as a under dash air conditioning unit, the fuse will need to be replaced with a larger one to handle additional amperage.

- Remove the 5 amp fuse from the location on the fuse block labeled “ELEC FAN”. Replace this fuse with a larger fuse that corresponds to the amperage rating the component you connected requires; **this fuse can NOT be larger than 20 amps.**

The 16 gauge #906 wire will only be able to handle a maximum rating of 20 amps.

The connection for powering an aftermarket component will depend on where the component is located. If the component is located within reach of the #906 wire on the inside of the Jeep, wire #901 will not be used.

- Route wire #906 to the component to be powered, using male and female disconnect terminals; connect the #906 wire to the terminal/stud/wire on the component requiring a switched ignition power source.

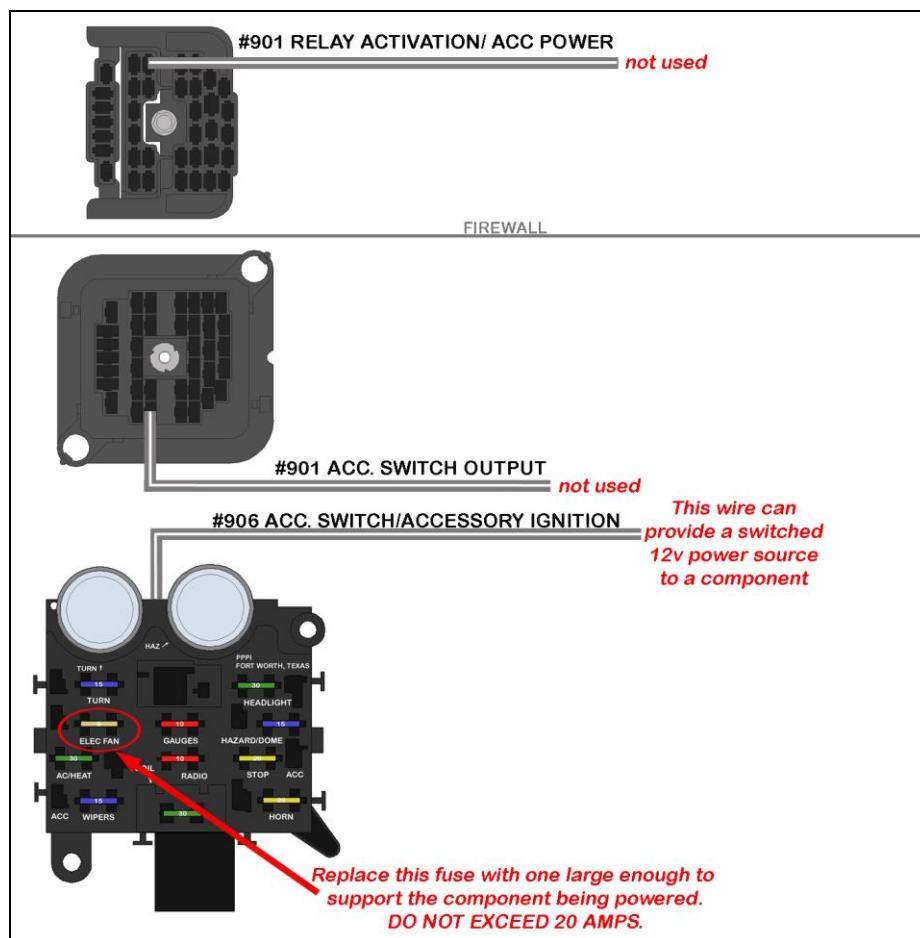

NOTES:

If a component is located in the engine compartment:

- Connect **#906** and **#901** together. This will supply power to the **#901** wire in the “ACC SECTION” of the engine harness. Wiring the component will take place in the instruction for that section on page 122.

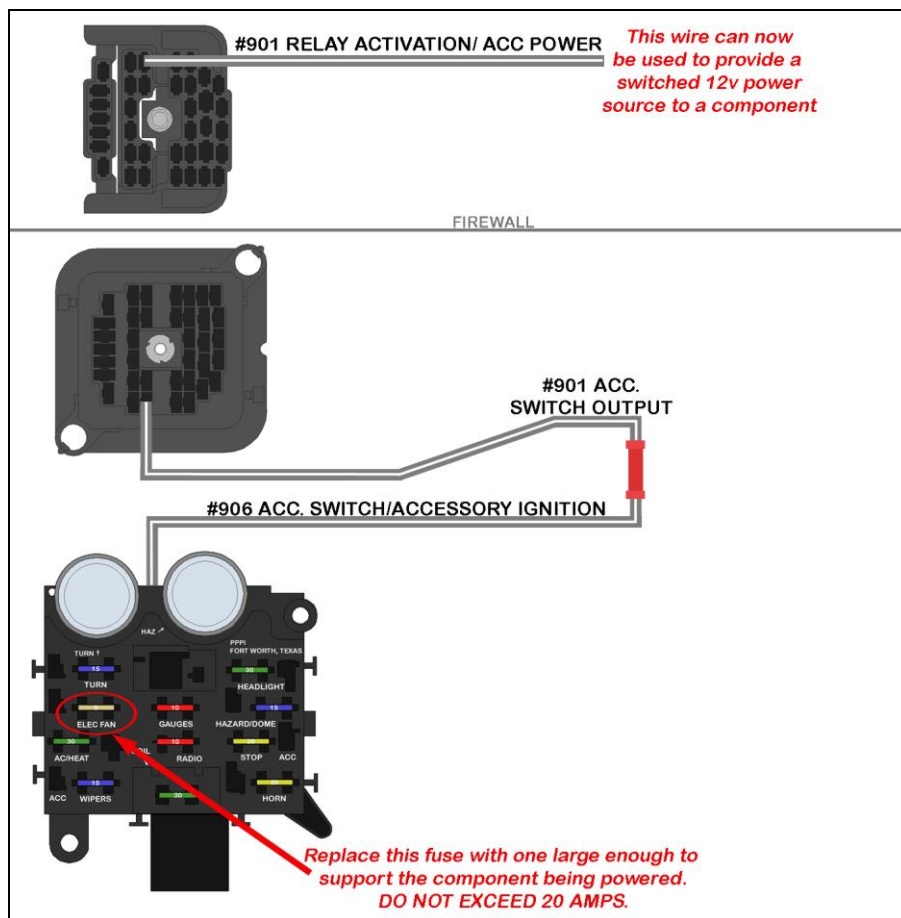

Aftermarket Components that include switches

Components such as air lockers or air compressors include installing a rocker switch or switches as part of the install process. These switches usually require a switched ignition power source. The **#906** will easily provide a good switched ignition source for such a situation.

- Route wire **#906** to the terminal requiring a switched power source on the switch or harness provided with such a component. This pin will usually be identified in a manufactures' instructions as “Ignition” or “To Ignition”
- Wire **#901** will not be used.



Relays

Those needing to activate relays have two options: power activate the relay or ground activate the relay. The difference will determine how the #906 and #901 wires are wired.

A 12 volt activated relay is constantly grounded and will send power out of the output side of the relay to the component being powered when 12 volts is applied to the relay, as the name implies. The 12 volt source can be wired directly to the relay or interrupted by a switch, as shown in the *12 VOLT SOURCE ACTIVATION* drawing.

Wiring directly to the relay, as indicated by the dashed line, would be used in the case of wiring a Fuel Pump relay, water pump relay, or any other high amperage component you would want to run continuously while the key is in the on position. In these cases, make certain the 12 volt wire you are using is a Switched 12 volt wire and not a battery constant hot.

The 12 volt activation wire can also be wired to a switch to offer the user OFF/ON capabilities. These are the situations a battery constant power source would be used. This would allow a component to be turned OFF or ON without the key in the ON position. However, unless a lighted switch is being used, a ground activated relay may work better to avoid running power through the switch.

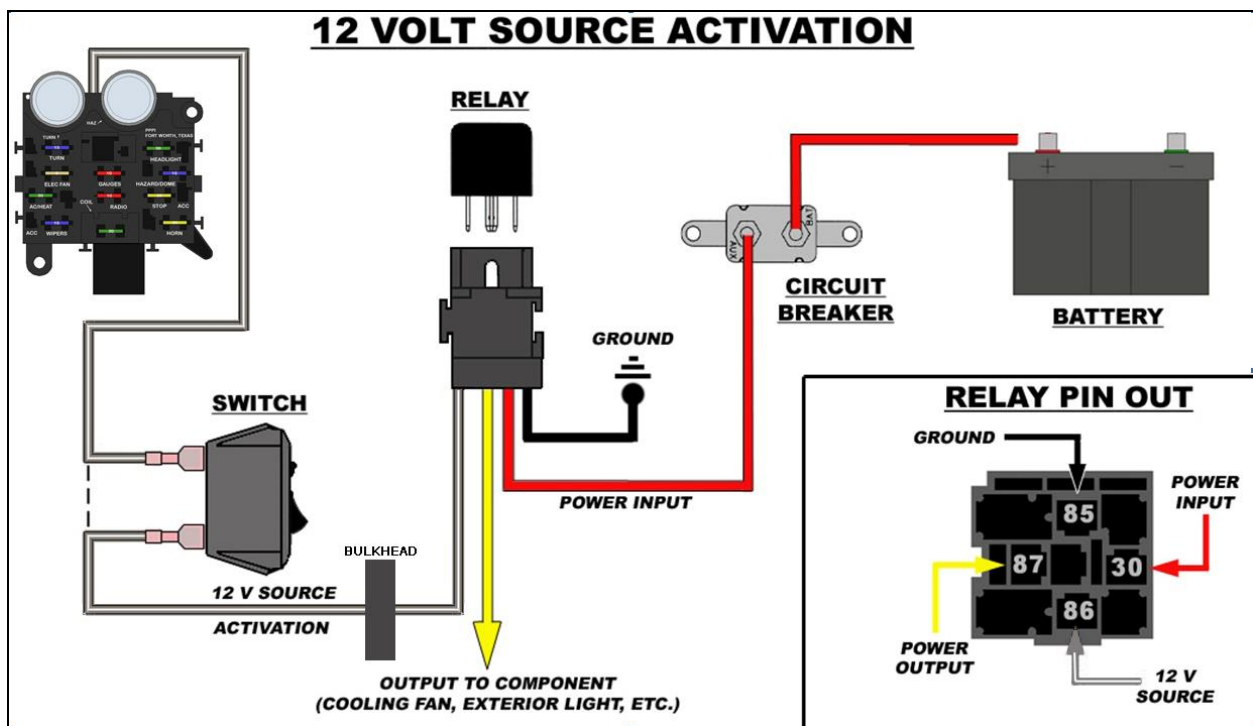

A ground activated relay is just the opposite of the 12 volt activated relay, 12 volts (battery constant or switched) is supplied uninterrupted and the ground wire is switched. The Horn Relay pre-wired in the Painless harness is a Ground Activated Relay. Another example of this method is a thermostat operated fan relay. In this case however, a thermostatic switch would replace the switch in the drawing below. Like mentioned before, ground activation method is best used when a component is operated by an unlit switch from the interior of the vehicle.

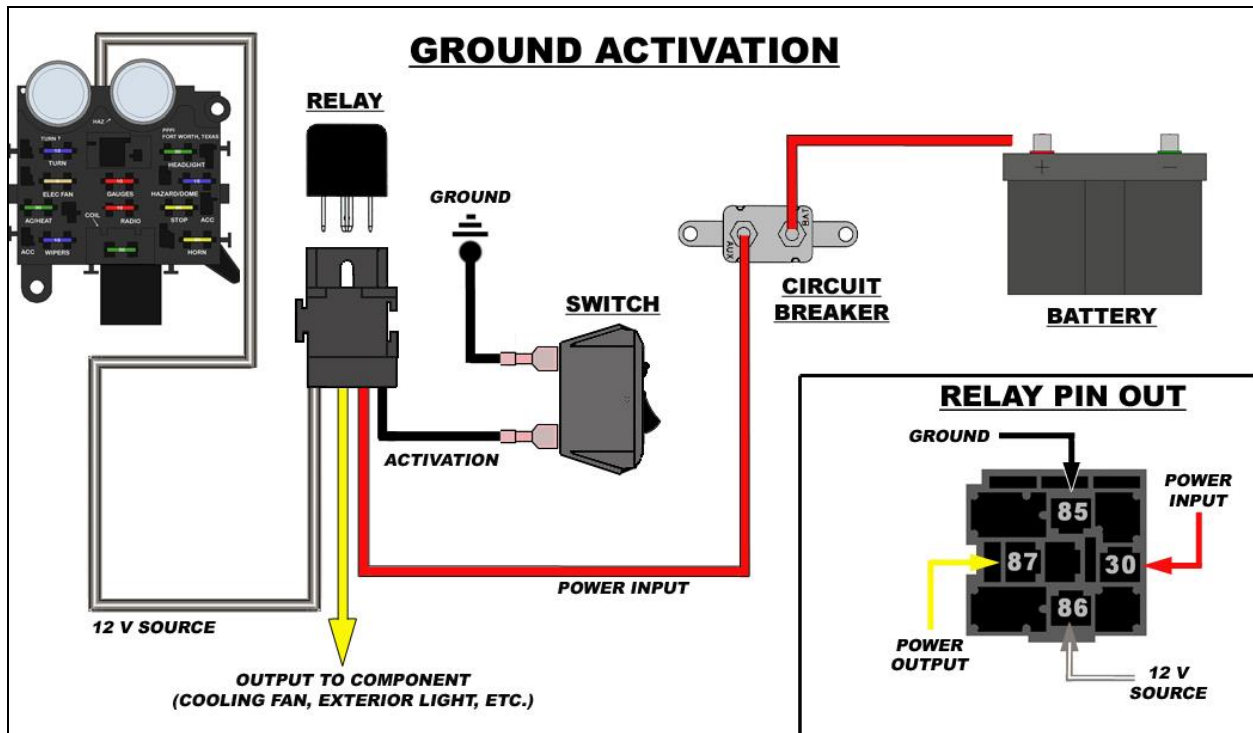

Now that relay activation has been explained, decide how the relay you are installing will be activated.

If you are ground activating a relay such as in the case of a cooling fan, a thermostatic switch, more commonly referred to as a coolant temp sensor connect according to the instructions below. The instructions below also work when installing a relay that will operate an electric fuel pump, water pump, or some other component that you want to activate anytime the key is in the “ON/RUN” position.

- If the relay is to be installed in the engine compartment: Connect **#906** and **#901** together using a red splice from the parts kit. This will supply power from the fuse block, through the **#906** wire, to the **#901** wire going to the bulkhead. Then, from the bulkhead in the engine compartment, to the **#901** wire in the “ACC SECTION” of the engine harness. Connection of that **#901** wire will be handled on page 122.
- If the relay is to be installed on the interior of the Jeep, not recommended for cooling fan relays: Connect the **#906** to the 86 pin of the relay. This will be the only wire supplied by the Painless harness for relay connection. See the second [ACC Relay Activation...](#) diagram on the bottom of the following page for the proper connection of the remaining relay pins.

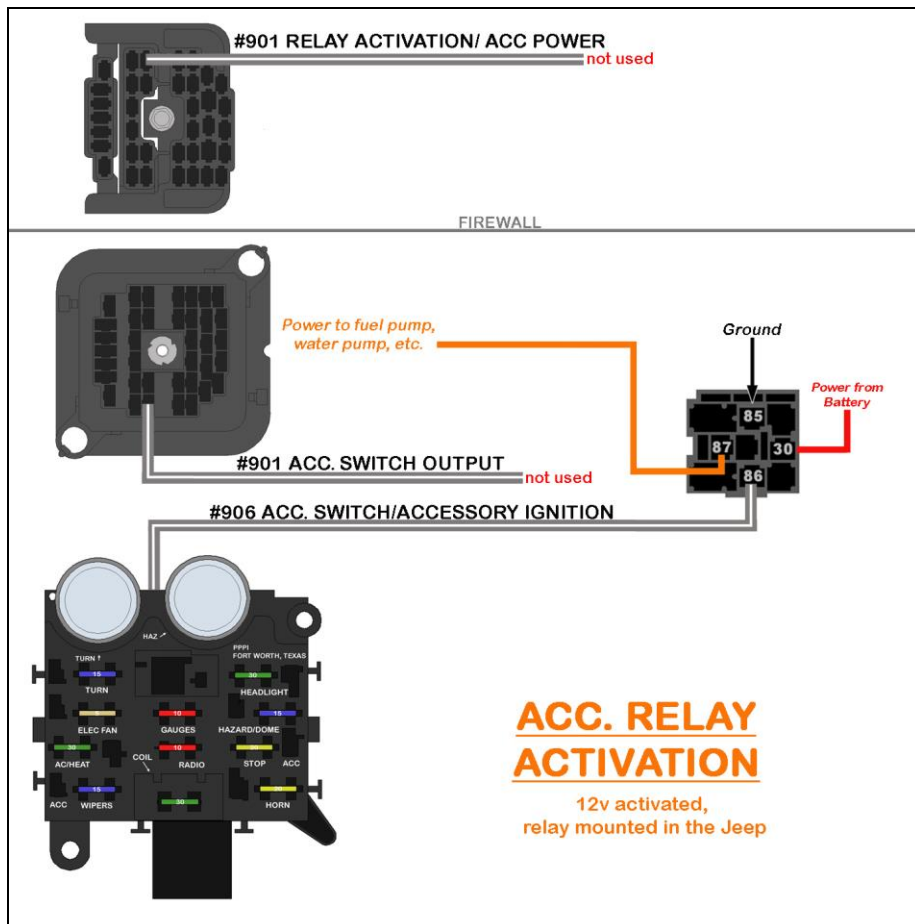
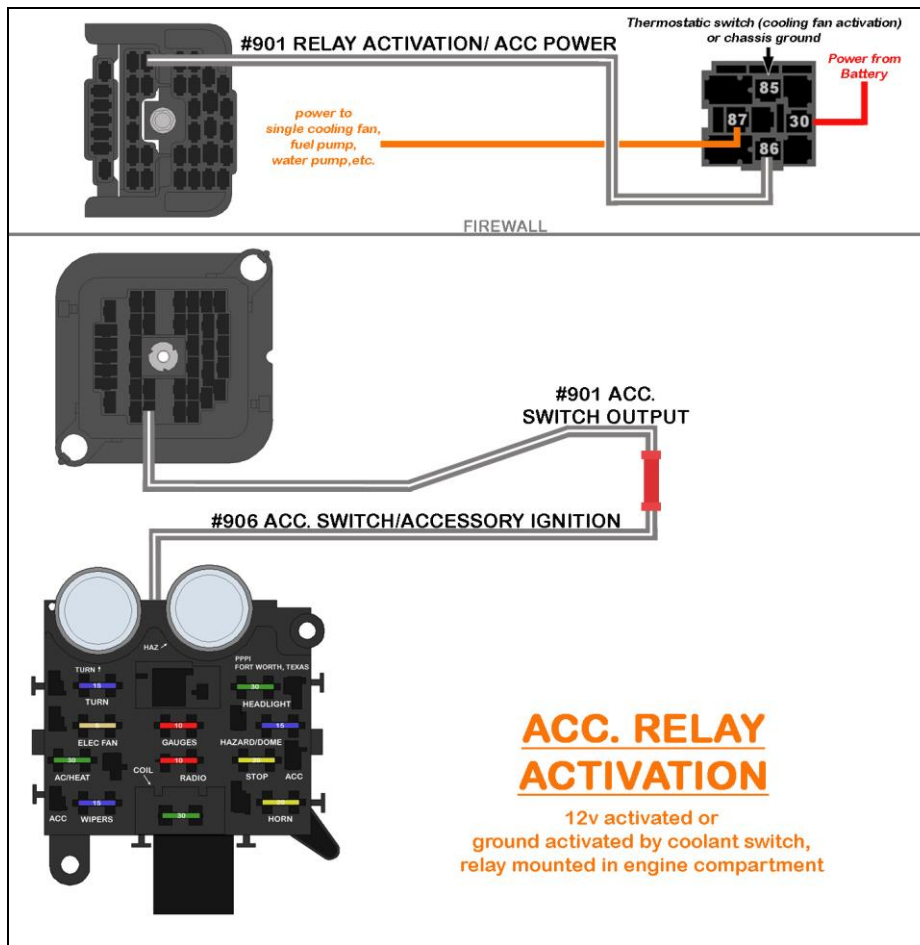

If you are installing a relay that will operate an electric fuel pump, water pump, fog lights or some other component that you want to activate with a toggle/rocker switch:

- Connect **#906** to the center post of the switch. This will supply power from the fuse block, through the **#906** wire, to the switch.
- Connect **#901** to the output side of the switch. This will send power from the switch to the bulkhead and from the bulkhead in the engine compartment, to the **#901** wire in the “ACC SECTION” of the engine harness. Connection of that **#901** wire will be handled on page 122.

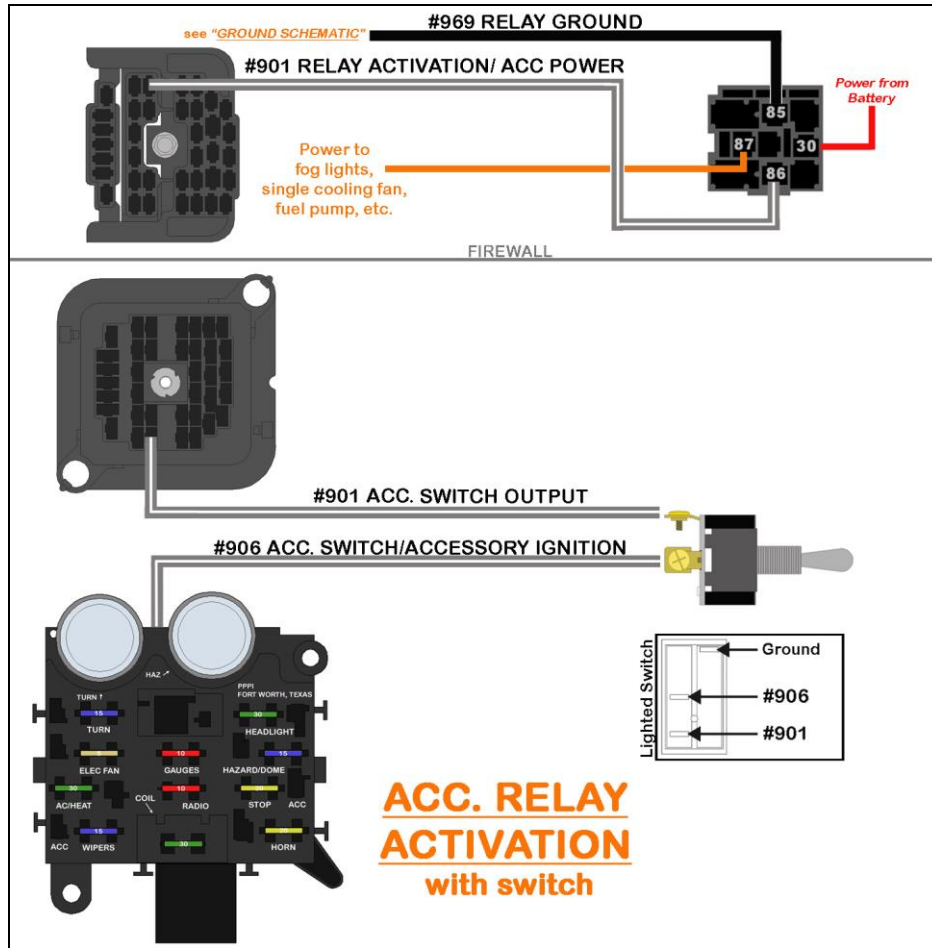

A/C Compressor

A single wire is provided for those running factory or aftermarket air conditioning systems. This single wire is intended to send switched ignition power from the air conditioning switch to the bulkhead, and then from the engine compartment bulkhead to the a/c compressor for activation. This wire is:

Brown: 14 gauge wire, printed **#902 A/C COMPRESSOR ACTIVATION**, this wire will have power when properly connected to an air conditioning switch, and the switch is in the “ON” position.

- Connect this wire to the pin or wire on the A/C system intended for a/c compressor activation.

“Heater Res.”

A connector labeled “HEATER RES.” can be found on the Painless harness. This connector will house three wires that come from the blower switch which control the blower speed. The three wires found in this connector can be seen in the [3 Speed Blower Schematic](#) on page 51, These wires are:

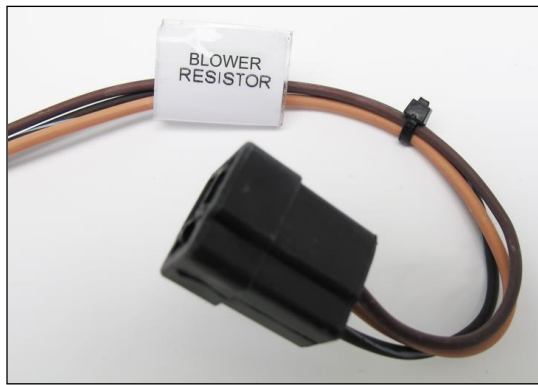

Tan: 14 gauge wire, printed #976 BLOWER MOTOR CONTROL/HIGH, this wire will provide power from the blower resistor to the blower motor. On 2 speed systems, this wire will provide power to the high side of the motor, and would have been a orange wire from the factory.

Brown/White: 16 gauge wire, printed #974 BLOWER MEDIUM, this wire provides power from the blower switch to the blower resistor. This wire is not needed on 2 speed systems.

Brown: 16 gauge wire, printed #975 BLOWER LOW, this wire provides power from the blower switch to the blower resistor. On 2 speed systems, this wire will provide power to the low side of the motor, this would have been a red wire from the factory.

3 speed systems

- Route and connect the pre-installed connector to the resistor. The resistor location is shown in the picture below.



2 speed systems

The use of the brown **#975** and tan **#976** wires, the brown/white **#974** will depend on how you connected the blower switch on page 48. Connections will be made to the blower motor as the 2 speed system do not have a resistor and have the blower motor connections on the inside of the Jeep.

- If you re-used the factory orange “HI” and red “LO” wires on the blower switch then connect the red and orange wires to the high and lo position on the blower motor. As shown in the [2 Speed Blower Schematic](#) on page 52.
- If you used the brown **#975** and tan **#976** wires at the blower switch, as instructed on page 51, removal of the connector pre-installed on the “HEATER RES.” wires will be required.

Cut the connector from the wires, **#974** is not needed, using splices or terminals from the parts kit, connect the #975 and #976 wires according to the [2 Speed Blower Schematic](#) on page 53.

THIS NOW CONCLUDES THE INSTALLATION OF THE INTERIOR HARNESS.

- The dash can now be installed back onto the body of the Jeep.

INTERIOR INSTALLATION NOTES:

Engine Harness Installation

The engine harness contains all of the connections from the firewall forward to the front of the Jeep. The engine harness is split into two main groups: a group containing connectors for the front exterior lighting and a second group containing mostly open ended wires to connect the different variations of starting, charge and ignition systems that came on the CJ Jeep or the possibility of countless combinations of aftermarket parts.

The engine harness installation will take place in 3 parts:

- The mounting of the bulkhead
- The routing and connection to the front exterior lights
- The routing and connection to the engine mounted components, and the start, charge, and ignition systems.

Bulkhead Mounting

The engine harness bulkhead will attach to the fuse block mounted bulkhead previously installed, page 23, on the firewall.

- Apply a small amount of the provided dielectric grease on each of the terminals on the bulkhead coming through the firewall. This will help seal moisture from contacting the terminals and protecting against corrosion. Remember to save some grease for the use on all exterior lighting bulbs.
- Plug the bulkhead on the engine harness into the bulkhead connector coming through the firewall.
- Using a Philips head screw driver, tighten the mounting bolt in the center of the bulkhead; **do not over tighten** as you could crack the center bulkhead connector.

Connection of the engine bay harness will begin with the routing and connection of the exterior lights.

- Locate the portion of the engine bay harness with the headlight, turn signal, and marker light connectors pre-installed. Route this group of wires down the driver side inner fender/wheel well. There are two connections that need to be made before this group of wires can be routed to the lights.

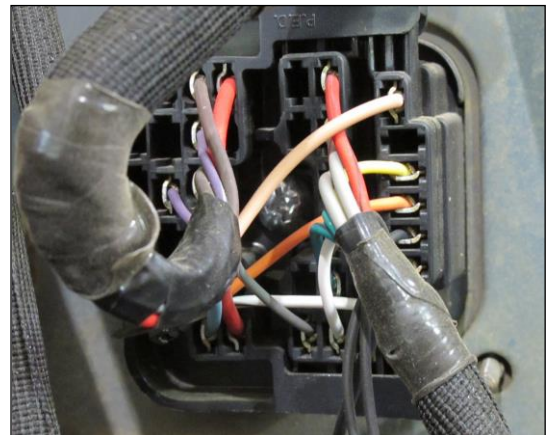

“Washer Pump”

The first connection to be made is the connection on the front lighting harness that is closest to the firewall. This connection will have a section label reading “WASHER PUMP”, these wires are:

Yellow: 16 gauge wire, printed **#983 WASHER PUMP POWER**, this wire supplies a power activation to the washer pump from the wiper switch. This wire will have power anytime the wiper switch is in the *WASH* position with the key is in the *ON/RUN* position. This wire will have a single pin connector preinstalled.

Black: 16 gauge wire printed with **#969 WASHER PUMP GROUND**, this wire will provide the Washer Pump with a ground source. This wire is part of the integrated ground circuit in this harness; it can be seen in the [Engine Ground Schematic](#) on page 13. This wire will be open ended.

- Connect the yellow **#983** wire to the tab on the wiper pump, the pump can be found on the bottom of the washer fluid reservoir.
- The factory pump was grounded by a wire coming from the pump to the firewall. You can re-use this wire if it is still attached and is good useable condition. If the ground wire is questionable or missing, use the black **#969** ground wire provided. A #6 ring terminal, #6 screw, star washer, and nut have been provided to connect this ground wire as seen in the photo to the right.
- If you are using an aftermarket pump, with two tabs and no separate ground wire hard mounted, and are unsure which tab is power and which is ground, hook it up how you believe it needs to be connected. If upon testing, bubbles blow into the reservoir instead of pumping fluid, simply swap the power and ground connections on the pump.



“Horn”

The next connection down the inner fender is the horn. This connection will have a label reading “HORN”; these wires are:

Red/Black: 16 gauge wire, printed **#924 HORN POWER**, this is power wire that comes from the fuse block mounted horn relay which is ground activated by the horn button on the steering column. This wire will only have power when the horn button is pressed.

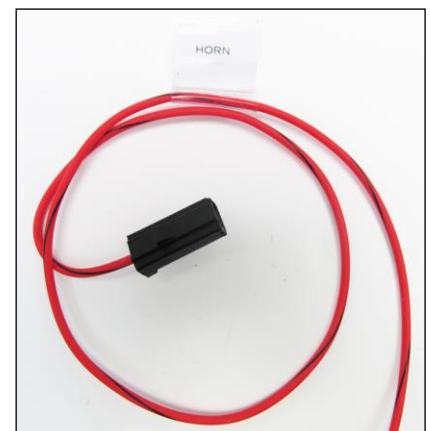

Black: 16 gauge wire printed with **#969 HORN GROUND**, this wire will provide the Horn with a ground source. This wire is part of the integrated ground circuit in this harness; it can be seen in the [Engine Ground Schematic](#) on page 13. This wire will be open ended and may not be needed on most applications.

- Locate the connection tab on the horn and connect the **#924** horn wire to the tab on the horn. This tab can be seen in the photo below.

- Horns ground through their mounting; most installs will only require a power connection and will not need the **#969** wire. If you have painted the inner fenders/engine bay since the factory harness was removed, Painless recommends installing a ring terminal on the **#969** wire and installing it to the bolt holding the horn to the mount to avoid sanding a newly painted surface to bare metal. A ring terminal and star washer have been provided in the parts kit to accomplish this.



Routing the front light wires can now take place.

- Route the remainder of the front lighting section to and through the access hole in the core support, across the top of the core support to the passenger side (**except for the driver side marker light**). Removal of the 2 conduit "T's" on the harness will be necessary.



“Marker Light”

The driver side fender mounted marker light is the next connection. This connection is not marked with a section label, but is easy to identify by the molded rubber light socket.

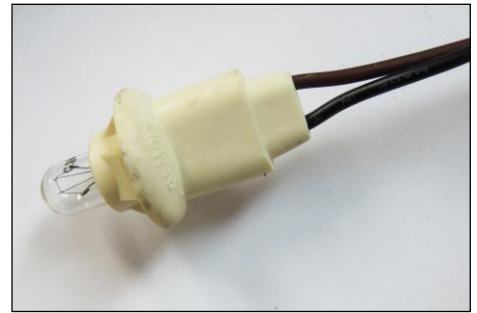

The marker light serves two purposes: it is a park light as well as a turn signal. The park light feature is activated by a power source coming from the headlight switch. This light will illuminate any time the headlight switch is in the *PARK* or *ON* position. The turn signal feature is provided by a power source coming from the turn signal switch.

The Left Side Marker requires two wires to work properly, seen in the [Turn Signal Switch Schematic](#) on page 33 and the [Headlight Switch Schematic](#) on page 43. A factory style socket comes pre-installed. The wires spliced to this molded connector are:

White: 18 gauge wire, printed **#927 LEFT MARKER LIGHT POWER**, this is a power wire for the park or marker light function. This **#927** is tied to the other **#927** wires in the Light Section. This wire will have power anytime the headlight switch is in the Park/Tail Lights ON or Headlights ON position.

Green/Black: 18 gauge wire, not printed, this wire is the power for the turn signal function. This wire goes into a splice with the light blue wire going to the front left turn/park light and to a wire coming from the bulkhead. This wire will have interrupted switched power from the turn flasher any time the left turn signal is activated and interrupted battery power from the hazard flasher any time the hazard switch is in the ON position.

Inspect the pre-mounted bulb and ensure the filament is still intact.

- Route the marker light through both access holes into the driver side wheel well. If it is not already removed, removal of the driver side headlight, as explained on page 88, will aid in this routing.

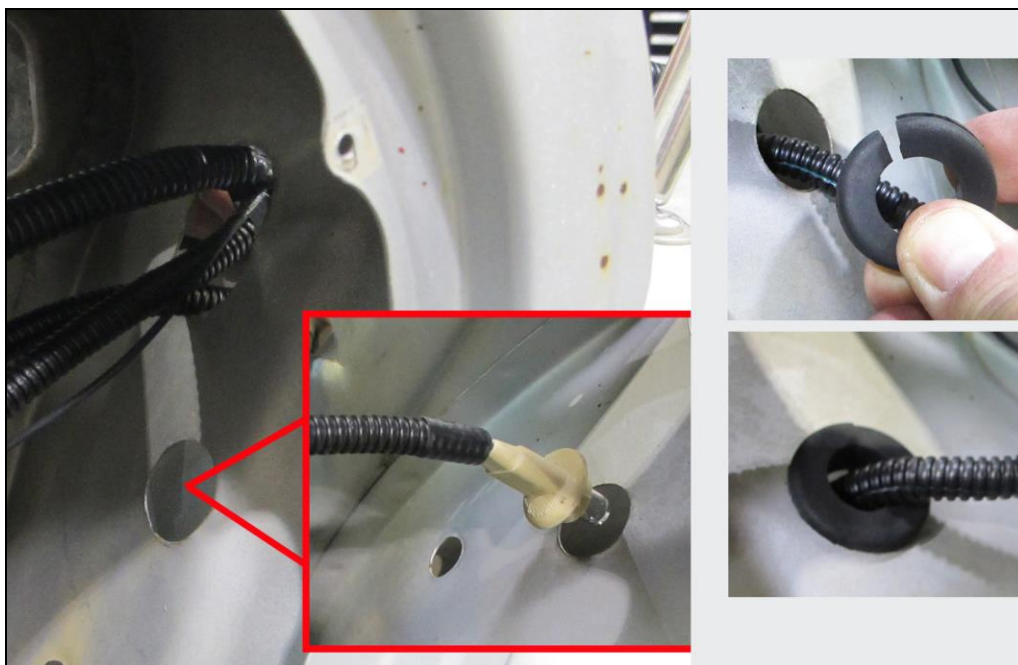

- Locate 2 of the 4 grommets provided in the bag kit, and splice/cut one side of the grommet so that it can be installed around the marker light conduit.
- Looking at the back of the marker lamp housing you will see that it has a keyed opening to correspond with the tabs on the socket. (similar to the one seen in the photo)
- Insert the lamp socket of the Painless harness into the “Left Side Marker” housing and turn ¼ turn to lock the socket in place.
- In the bag kit you will notice 2 steel & rubber clamps, these clamps are for the driver and passenger side marker light wiring. These clamps will keep the wiring and conduit from sagging. Use the bolts holding the hood catch to mount the clamp.

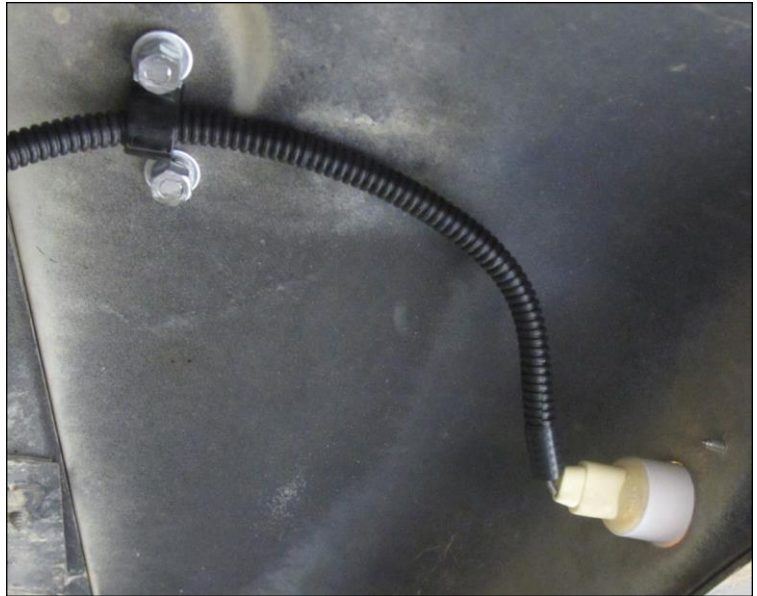

“Left Headlamp”

Three wires make up the connection to the Left Headlamp. These wires go into a black three pin connector. This group of wires will not have a section label, these wires are:

Gray/Red: 14 gauge wire, printed **#908 HIGH BEAM POWER**, this wire will provide power to the high beam filament of the head lamp. This wire goes into a splice with a wire going to the right headlamp and also to a wire going to the bulkhead and can be seen in the [Headlight Switch Schematic](#) on page 43. This wire will have power when the dimmer switch is in the high beam position and the headlight switch is in the headlight ON position. There is another Gray/Red **#908** doubled up with this wire, this other wire feeds high beam power to the passenger side headlight.



Gray: 14 gauge wire, printed **#909 LOW BEAM POWER**, this wire will provide power to the low beam filament of the head lamp. This wire goes into a splice with a wire going to the right headlamp and also to a wire going to the bulkhead and can be seen in the [Headlight Switch Schematic](#) on page 43. This wire will have power when the dimmer switch is in the low beam position and the headlight switch is in the headlight ON position. There is another Gray **#909** doubled up with this wire, this other wire feeds low beam power to the passenger side headlight.

Black: 14 gauge wire, printed **#969 HEADLIGHT GROUND**, this wire provides a ground source for the headlamp. This wire is tied into the integrated ground circuit and can be seen in the [Ground Schematic](#) on page 13.

Removing the headlight will be necessary to connect the headlight connector to the headlight. A Philips head screw driver will be necessary for this.

- Remove the two screws holding the outer trim bezel of the headlight.
- Remove the three screws holding the headlight retainer ring. Hold the headlight in place while removing these screws, once the retainer ring is loose the headlight will fall out.



- Route the headlight connector through the headlight bucket.
- Plug the connector into the back of the headlamp. Use caution while installing as the tabs on the headlamp will easily bend if the connector is installed at any sort of angle.
- Reinstall the headlight, retaining ring, and trim bezel.

If halogen bulbs are being used Painless recommends using a separate relayed headlight harness, such as Painless part **#30815**, seen to the right.

This headlight relay kit is needed to avoid overloading the headlight switch and wiring of this Painless chassis with the higher demands of halogen bulbs. Part **#30815** will plug right into the connectors found on this chassis harness as well as factory harnesses.



“Left Turn/Park Light”

The last connection needing to be made on the left side of the Jeep is the “Left Turn/Park Light”. This light has a dual filament bulb that works as a turn signal as well as a park light. The turn signal will be the brighter of the two filaments.

New bulbs for the front Turn/Park Lights have been supplied. The bulb this lamp requires has universal part number 1157A, replacement bulbs can be found at any auto parts store under this part number. **Clear 1157 bulbs cannot be used.** Amber bulbs must be used as laws require the front turn signals to be amber in color. Most vehicles have colored lenses to comply with this law, in which clear 1157 bulbs may be used.



- Apply a very small amount of dielectric grease to the entire metal contact area on the bulb, as well as a very small amount into the lamp socket.

The Left Turn/Park Light of the Painless harness consists of one connector, a two pin, and a single open ended wire. These wires do not have a section label. These wires can be seen in the [Turn Signal Switch Schematic](#) on page 33 and the [Headlight Switch Schematic](#) on page 43; these wires are:



Two pin connector

White: 18 gauge wire, printed **#927 PARK LIGHT POWER**, is the power source for the park light. This **#927** is tied to the other **#927** wires in the Light Section. This wire will have power anytime the headlight switch is in the Park/Tail Lights ON or Headlights On position.

Green/Black: 18 gauge wire, printed **#925 FRONT LEFT TURN SIGNAL POWER**, this wire is the turn signal power. This wire goes into a splice with the green/black wire going to the front left marker light and to a wire coming from the bulkhead. This wire will have interrupted switched power from the turn flasher any time the left turn signal is activated and interrupted battery power from the hazard flasher any time the hazard switch is in the ON position.

Open ended wire

Black: 18 gauge wire, printed **#969 TURN SIGNAL GROUND**, this wire provides a ground source for the turn/park lamp for those using fiberglass front ends. This wire is tied into the integrated ground circuit and can be seen in the [Ground Schematic](#) on page 13.

Removing the turn signal from the grille will be necessary to make this connection. A Philips head screw driver will be required for this.

- Remove the two screws holding the lens and turn signal assembly to the body.
- Apply a small amount of dielectric grease to the connector on the Painless harness and then plug the chassis harness connector to the connector coming from the turn signal lamp assembly.
- This assembly grounds through the mounting to the body. On freshly painted Jeeps or those with a fiberglass front end, use the black **#969** to provide a ground to the turn signal assembly. This can be done by using a ring terminal and using a lens/mounting screw to secure the ground.



“Right Turn/Park Light”, “Right Headlamp”, & “Right Marker Light”

The 3 connections mentioned above all connect in the same manner as those on the left side. The only difference you will find is the Turn signal wire for the right turn signal is a different color than that one used for the left turn signal. The right Turn signal will be an printed 18 gauge green wire, printed **#926 FRONT RIGHT TURN SIGNAL POWER**.

“Brake Warn. Switch”

Connection to the brake warning switch is only necessary if you want the brake warning light in the dash to indicate low brake fluid pressure. If you have aftermarket gauges without a brake warning light, then this connection can be skipped.

A brake warning switch is a normally open switch that will close and send a ground signal to the brake light indicator light on the dash. This is done when the bias valve inside the proportioning valve has shifted forward or back because of line pressure differences. This is usually caused by broken/leaking brake line or faulty caliper or wheel cylinder. Please be aware this is a pressure switch not a fluid level switch.



This connection will be two wires that come from the right hand side of the bulkhead and will not be grouped with any other wires. This connection will have a two pin "T" shaped connector pre-installed. These two wires are:

Black: 18 gauge wire, not printed, this wire supplies a ground signal to the low brake light on the dash, which will complete the circuit to the light causing it to illuminate. This wire goes into the bulkhead connector and on the fuse block mounted bulkhead it is doubled with the wire going to the emergency brake switch on the interior of the vehicle; see the [Cluster Schematic](#) on page 62.

Black: 18 gauge wire, not printed. This will provide a ground source to the low brake light on the instrument cluster when the key in the start position. This will indicate that the bulb is operable and will indicate when a low brake fluid pressure condition occurs or if the emergency brake is still applied. This wire can be seen in the [Ignition Switch Schematic](#) on page 32.

The factory brake warning switch is a two pin switch located on the proportioning valve, under the steering shaft, on the frame. It's easy to find by following the brake lines to the frame. If you have an aftermarket proportioning valve, you may not have one of these switches or notice you only have one pin. Please be aware that if you are using a universal aftermarket valve with a metal cased two pin connector, as seen below right, this switch is for brake light activation not for a brake warning.

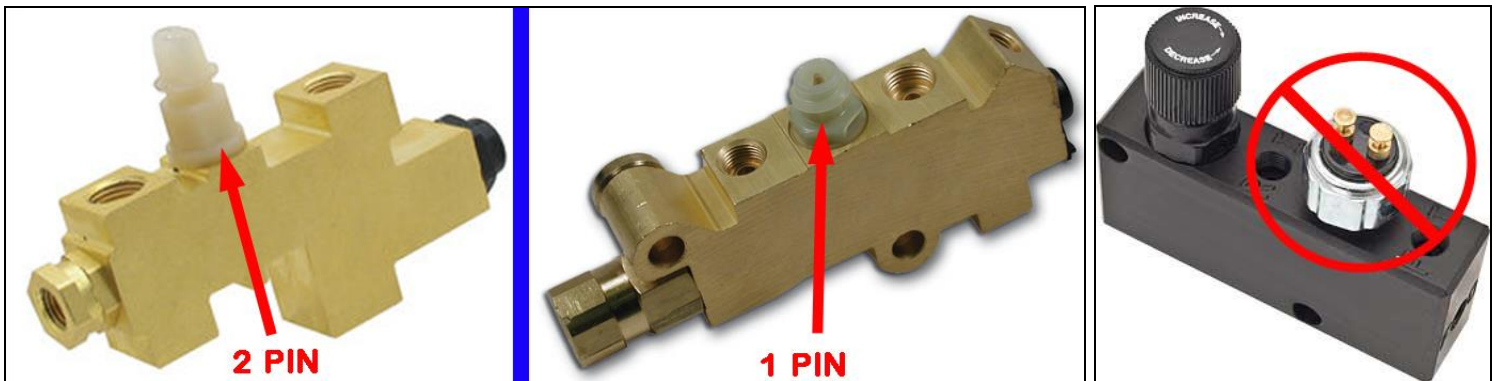

The connection on the Painless harness connects to the factory pigtail that comes from the two pin switch.

- Apply a small amount of dielectric grease to the connector on the Painless harness and then plug the chassis harness connector to the connector coming from the brake warning switch.



Those with a single pin brake warn switch; a pigtail to the one pin switch will be needed.

- Cut the connector from the Painless harness.
- Splice both black wires on the Painless harness to the single wire pigtail.

The remainder of the engine harness, containing sections such as "COIL", "ALTERNATOR", "STARTER SOLENOID", and others, can now be routed along the firewall towards the passenger side of the Jeep.

- Route the group of wire across the fire wall. Use the ¼ zip ties/clips, provided in this kit, to secure this group to the firewall.

"Under Hood Light"

For those with an under hood light, this next connection will supply the power wire this light requires.

Coming from the bulkhead, locate the wire with a section label reading "UNDER HOOD LIGHT". This will be a single wire with a white single pin connector, this wire is:

Orange: 16 gauge wire, printed #971 UNDER HOOD LIGHT POWER, this wire provides battery power to the under hood light. This power comes from the 10 amp DOME fuse.

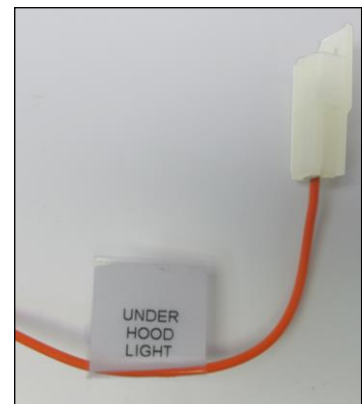

For the light to function it only requires a power wire. The light is turned off and on by a mercury switch inside of the light making contact when the hood/light is in the up position.

- Route the orange #971 wire to the under hood light and connect the Painless chassis harness to the connector found on under hood light. Be aware of pinch points like around the hood hinges and where the hood closes at the cowl.
- This light only requires a single battery power wire as this light grounds through the housing/mounting. Those using a fiberglass hood, run a ground wire, not supplied, from the mounting bolt to a clean chassis ground source.



“NSS/REVERSE SWITCH”

Those that have an automatic transmission and the reverse switch and NSS switch were connected on the steering column, beginning on page 29, this connection can be skipped.

A connector has been pre-installed on the engine harness for those with a 1980-1986 manual transmission which has a reverse switch mounted on the transmission. A pigtail has been provided for those with earlier Jeeps. This connector will also provide a wire for those with a neutral safety switch built into the reverse switch, as seen in the photo on page 95 and further explained on page 122. There are four wires going to this connector, they are:

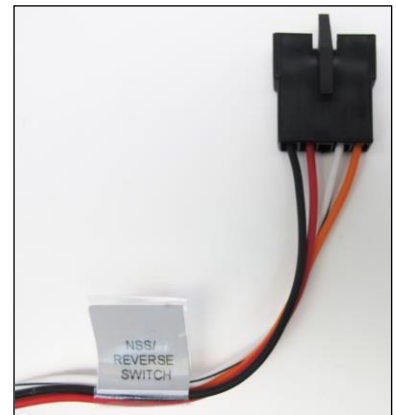

Orange: 16 gauge wire, printed #984 4WD INDICATOR ACTIVATION, this wire will provide a ground signal through the bulkhead to the light on the gauge cluster when the four wheel drive is engaged. This wire can be seen in the [Cluster Schematic](#) on page 62.

Black: 16 gauge wire, printed #998 NSS TO STARTER RELAY GROUND, on Jeeps equipped with a transmission mounted NSS, this wire will provide a ground signal to a

mopar starter relay or a starter solenoid with a ground stud. This wire can be seen in the MOPAR [SR 14 Starter Relay Schematic](#) on page 124.

Red: 16 gauge wire, printed #958 REVERSE LIGHT SWITCH POWER, this wire provides switched ignition power from the “RADIO” fuse to the reverse switch. This wire will have power any time the ignition switch is in the *ON/RUN* or *ACC* position.

White/Black: 16 gauge wire, printed #956 POWER TO BACK UP LIGHTS, this wire will provide power from the reverse light switch to the back up/reverse lights. This wire will only have power when this wire is connected to a reverse switch, the transmission is in the reverse position, and the ignition switch is in the *ON/RUN* or *ACC* position.

With so many different configurations of reverse switches, this connector on the Painless harness is intended to plug into the factory pigtail that comes from the 1980-1986 transmissions as they all shared the same inline harness connection as seen in the [Factory Reverse Switch Pigtail](#) diagram on the next page.

- Route the connector labeled “NSS/REV SWITCH” to the connector on the pigtail coming from the transmission and connect the two together.

If you have a 1976-1979 Jeep, a 1980-1986 missing the factory pigtail, or a transmission that was not a factory option, an open ended pigtail has been provided. This pigtail, shown to the right, will allow for a connection to take place to the “NSS/REV SWITCH” and allow you the installer to custom fit the pigtail to your particular transmission.

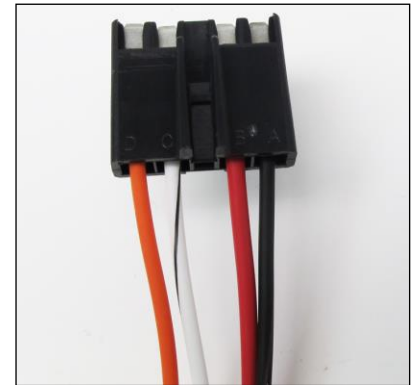

The wire colors on the pigtail, as well as the function of each wire, can be seen above in bold. Instructions are provided on the following pages for connection to a reverse switch as well as for the four wheel drive indicator.

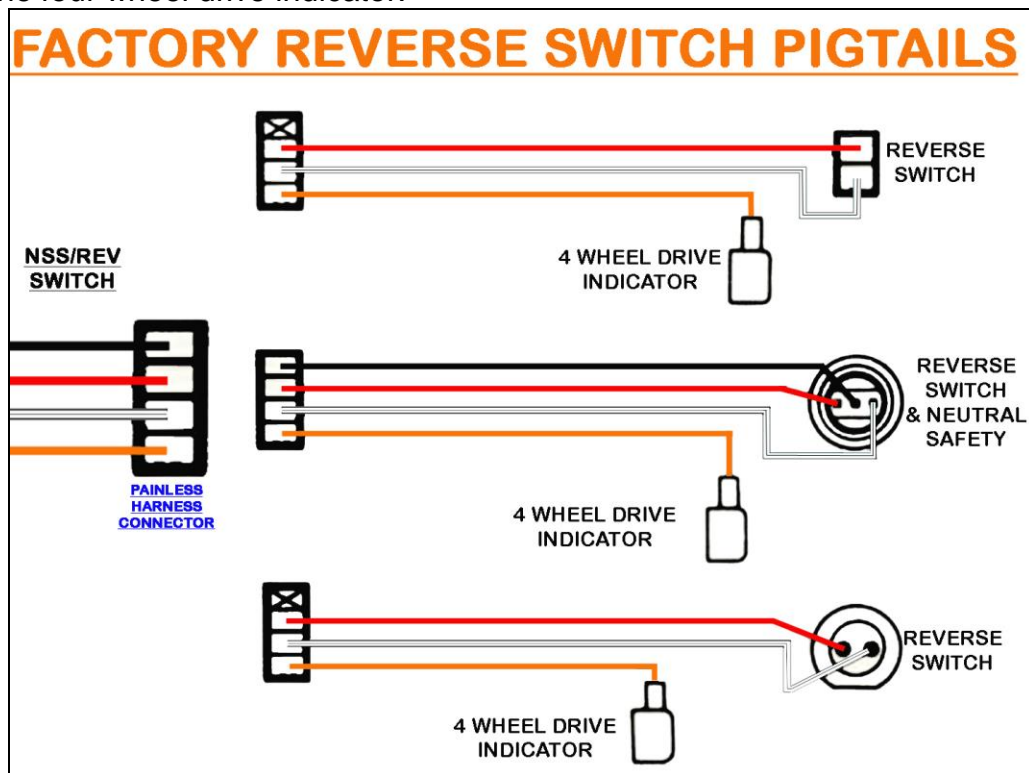

Reverse Switch:

On manual transmissions that were factory options for a Jeep CJ, the reverse switch can be found near where the shifter is located, as seen in the photo.

- Route the red and white wires from the pigtail to the reverse switch, keeping in mind to avoid any pinch points. In most cases, the black wire will not be needed. Only those with a 3 pin reverse switch, like shown in the middle of the diagram above, will need the black wire. If needed, this black white wire can be routed at this time.
- A connector and terminals, seen below, have been provided, this will attach to most factory reverse switches. Use the diagram above for proper connection locations. On two pin switches it does not matter which pin the red and white wires are installed on. 3 pin switches used a molded connector which will need to be spliced to the wires coming from the Painless pigtail.

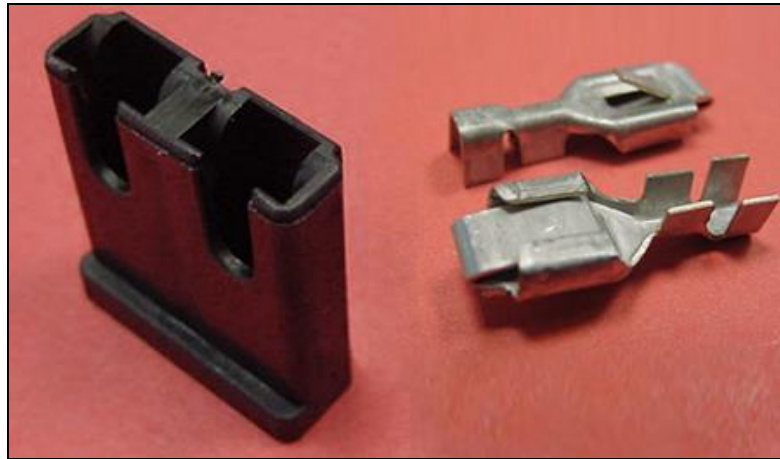
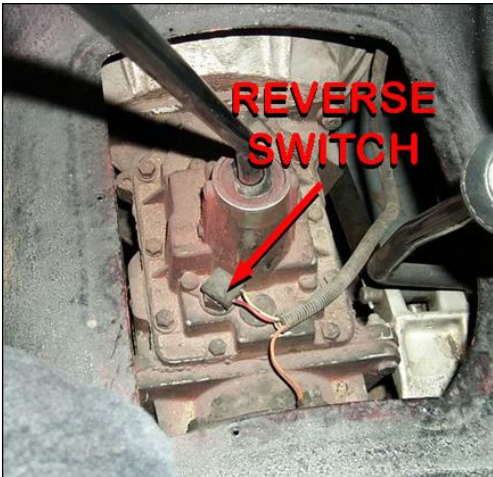

Four Wheel Drive Indicator:

The 4wd indicator switch will be on the top, right hand side of the transfer case. Not all transfer cases will have a four wheel drive indicator switch.

- Route the orange wire to the four wheel drive indicator switch.
- This switch originally had a molded connector, if you have this connector splice it to the orange wire on the pigtail. If you do not have a molded connector one of the various sizes of insulated sockets terminals or a ring terminal and a 10-32 nut can be used on switches with a threaded stud.

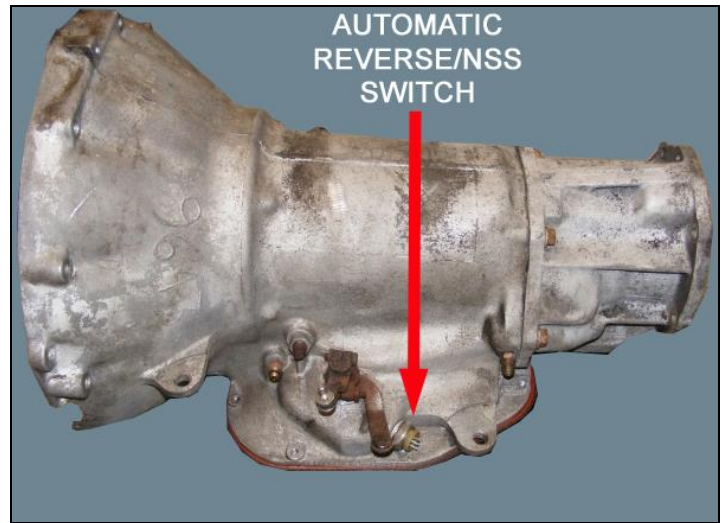
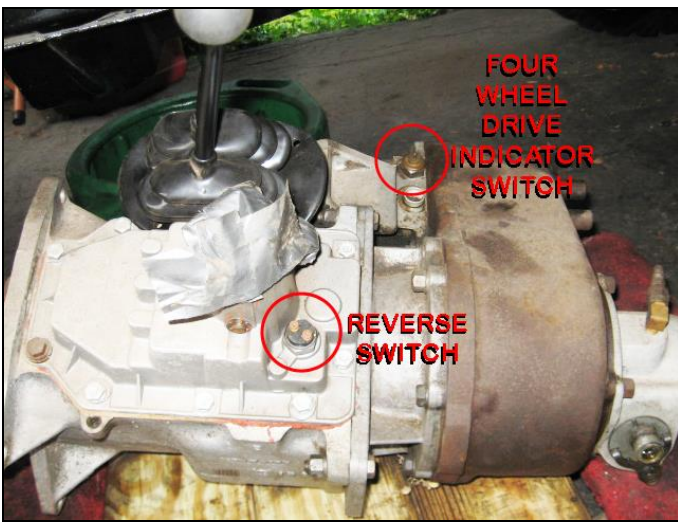

“COIL”, “ENGINE SECTION”, “ALTERNATOR”, “STARTER SOLENOID”, “FAN RELAY”

The above mentioned groups will all be clearly labeled. All of these groups are open ended and universal in nature allowing numerous ignition systems, charging systems, and starter configurations to all be supported by this harness. Everything from factory engine options, with the exception of the manifold heater and emission control equipment found on 1982+ Jeeps, to non factory motor swaps, like Ford or Chevy V8s, can be connected using the wires in these sections.

“Coil / Ignition”

Power

Power to the coil / ignition system is supplied with a single wire coming from the bulkhead. The connection of this wire will vary depending on what ignition system, factory or aftermarket, you use. The wire needed to supply a switched ignition power source is:

Red/White: 16 gauge wire, printed **#920 COIL POWER (+)** this wire comes from the 30 amp COIL fuse. This wire will have power anytime the ignition switch is in the *ON/RUN* and *START* positions. This wire will provide the coil / ignition system with switched power in one of four ways:

- If the Coil you are using is not internally resisted, a ballast resistor, along with the brown **#970** wire mentioned in the next step, must be used. A ballast resistor, provided in the kit and seen to the right, resists the current going to the coil. Wire **#920** will connect to one side (it doesn't matter which) of the ballast resistor, then the portion of **#920** that was cut off will connect the other side of the ballast resistor to the coil. **If a coil is not internally resisted and a ballast resistor is not used, the coil will overheat within a few minutes to the point it will no longer work.**

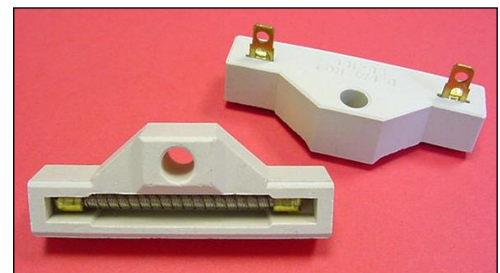

If the ballast resistor is to be used, please be aware that the resistor does get very hot during normal operation, keep it away from other wires. You may even notice it slightly smoking due to oils from your hands on the first initial power cycles, this is normal. Also, during installation, in which a self tapping screw has been provided in the parts kit, avoid over tightening the screw. This can crack the ceramic of the ballast resistor.

- Factory Prestolite BID ignitions and HEI coils, like factory 1980-1983 4 cyl ignition systems and common on Chevy V8 motor swaps, do not require the use of a ballast resistor. The **#920** wire will connect directly to the + side of the coil. See the [1980-1983 4cyl Connections](#) on page 103, [HEI Connections](#) on page 102, or [Prestolite BID Connections](#) on page 101.
- If an aftermarket Ignition box is being used, such as an MSD, Accel, etc., the ballast resistor will not be needed. This red/white **#920** wire will supply the Ignition box with the switched power source it requires. This wire will go to the aftermarket ignition box and **not the Coil**; the Ignition Box will provide the Coil + connection. This **#920** wire may need to be pulled from the **Engine Section** and routed to where the box is mounted. See the Ignition box manufacturer's instructions for a specific connection point of this power source. [MSD Ignition Connections](#) on page 1103 has been provided.
- If you have converted to fuel injection and are using a standalone harness, such as any of Painless fuel injection harness, and coil power is supplied through the fuel injection harness, as is the case for most LT1/LS1 and newer applications, this red/white wire will provide the fuel injection harness with the switched power source the harness requires. If using a Painless fuel injection harness, this red/white **#920** wire will connect to the open ended Pink wire of the fuel injection harness labeled "IGN" or "Fuse Block IGN".

- At this time find a suitable location for the ballast resistor, if one is needed. As seen in the photo, the ballast resistor can be mounted anywhere on the firewall, however the **#920** wire may need to be re-routed in the harness to reach your mounting location.

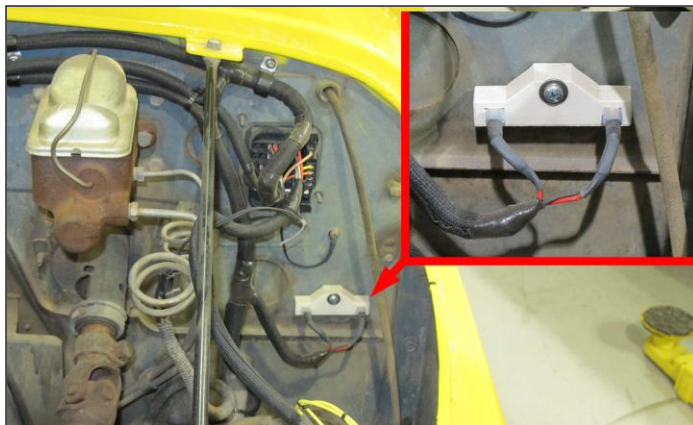

- Route the Red/White **#920** wire to its proper connection point, according to the diagrams mentioned on the previous page, and cut to length. Install the appropriate terminal for your connection, and connect.

Terminals and a factory style connector, seen in the photo at right, have been supplied to allow connecting to the + side of a HEI Coil.

An added bonus of the "COIL" fuse on the fuse block is it also provides a built in theft deterrent. Removing the "COIL" fuse from the fuse block when the Jeep is parked for periods of

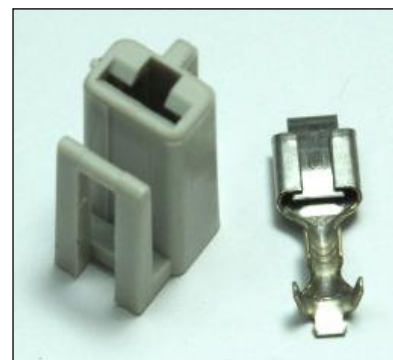

time will not allow the ignition system to function, making the vehicle virtually impossible to start/run. What “would be” thief is going to trouble shoot power to the coil?

Tachometer

The next wire will only be connected if you are using a factory 4 cyl., universal aftermarket tachometer, or aftermarket factory style tachometer. Those who are using a factory or do not have a tachometer, this wire will not be connected and may be removed from the harness.

Purple: 18 gauge wire, printed **#923 TACHOMETER SIGNAL/COIL (-)**, this wire will send tachometer signal from the coil to the gauge cluster.

Connection of this wire will vary depending on your ignition system (factory or aftermarket) or use of fuel injection. This tachometer wire is:

- Standard factory type of installs with a HEI distributor or external coil ignition systems, will require this **#923** wire to be connected to the negative “-” side of the coil. Refer to the diagrams beginning on page 98 for proper connection.

Terminals and a factory style connector have been supplied to allow connecting to the - side of a HEI Coil, seen in the photo at right. Rollover crimpers will be needed to properly install this terminal. Insulated terminals in the parts kit have been supplied to make other connections.



- If you are running fuel injection and your ECM has a tach output wire, and the tach output wire of the fuel injection harness will not reach the tachometer, this **#923** wire will connect to the tach output wire from the ECM.
 - If an aftermarket ignition box is being used, such as an MSD, Accel, etc., this **#923** wire will connect to the tach output found on the ignition box. Refer to the ignition manufacturer’s installation instructions or to the [MSD Ignition Connection](#) page 103.
- Route this Purple **#923** tach signal wire to its proper connection point and cut to length, install the appropriate terminal for your connection, and connect.

“Ignition Module” Bag

Provided with this Painless 10150 chassis harness is a bag labeled “Ignition Module”. This bag contains the additional wiring you will need to connect to factory ignition modules used during the production of CJ series Jeeps. **This will be wires only, no connectors.** The factory connectors to your ignition harness will need to be reused from your original harness.

If you are using a Duraspark ignition system and wish to not have to reuse connectors, Painless offers two different Duraspark harnesses which come pre terminated and ready to connect to the coil, distributor, and module. These Duraspark harness are offered under part [#30812](#)



(4cyl) & #30819 (6 & 8 cyl). The difference in these 2 harnesses is the coil wiring length, 30819 being longer. Refer to the instructions provided with these Duraspark harnesses for proper installation.

If the #30812 or #30819 harness is used, you will not need the wires contained in the "IGNITION MODULE" bag.

Ballast Bypass

On vehicles utilizing a ballast resistor, a wire needs to connect the positive side of the coil to the "I" terminal of the starter solenoid. This will provide the coil a full 12v power source when the starter solenoid is engaged by bypassing the ballast resistor and going directly to the coil. This is done to facilitate starting the engine when cold and will not harm the coil. If connected to the starter solenoid correctly, as indicated on page 122 and shown in the diagrams on pages 101 & 102, this wire will only have power when the ignition switch is in the START or "crank" position. This wire is:

Brown- 18 gauge wire, printed **#970 BALLAST BYPASS-STARTER RELAY/SOLENOID "I"**. This wire will only be needed if you are using a ballast resistor

- Route the brown #970 wire to the + side of the Coil or to the output side of the Ballast resistor.

The other end of this #970 wire will route to the "I" terminal on the starter solenoid. Connection will be covered later in the manual on page 122

Power

Duraspark and Prestolite ignition systems require a 12v switched ignition power source to the ignition module. This bag contains a wire for this purpose.

Red/White: 16 gauge wire, printed **IGN MODULE- IGN POWER**

- On Duraspark systems, route this wire to the 12v input side of the ballast resistor. This will be the side that has the #920 wire (p. 93) that comes from the bulkhead. This can be seen in the [Duraspark Connections Diagram](#) on page 102.

Double up the **IGN MODULE- IGN POWER wire** with the #920 wire into a blue insulated push on terminal, crimp, heat shrink, and connect.

- On Prestolite ignitions, route this wire to the positive side of the coil with the #920 wire as seen in the [Prestolite BID Connections](#) on page 101.
- On Duraspark and Prestolite ignition systems, route the other end of this wire to the power wire on the ignition module. As seen in [Duraspark Connections Diagram](#) on page 102 this will be a red wire. As seen in the [Prestolite BID Connections](#) on page 101, this will be a white or a red wire depending on your module.

Signal

Duraspark and Prestolite ignition systems require a Coil "-" or tach signal to feed the ignition module. This bag contains a wire for this need.

Green- 16 gauge wire, printed **IGN MODULE - SIGNAL**

- Route the green ... **SIGNAL** wire to the “-”side of the Coil and connect.

The other end of this wire will route to the tach signal wire on the ignition module, this will be a green wire from both Duraspark and Prestolite modules, as seen in [Duraspark Connections Diagram](#) and [Prestolite BID Connections](#) on pages 101 & 102.

Crank Signal

Duraspark ignition modules require a crank signal to alter the timing during start up. This bag contains a wire for this purpose.

Light Blue- 16 gauge wire, printed **IGN MODULE- CRANK SIGNAL**

- Route this wire to the crank signal, white, wire on the ignition module as seen in [Duraspark Connections Diagram](#) on page 102.
- Route the other end of this wire to the Starter solenoid, connection to the starter solenoid will take place on page 121.

Use one of the following six diagrams to properly connect the coil power (#920), tachometer (#923), and wires contained in the “IGNITION MODULE” bag.

All wires represented in the diagrams as a simple black line are NOT included with the 10150 harness

NOTES:

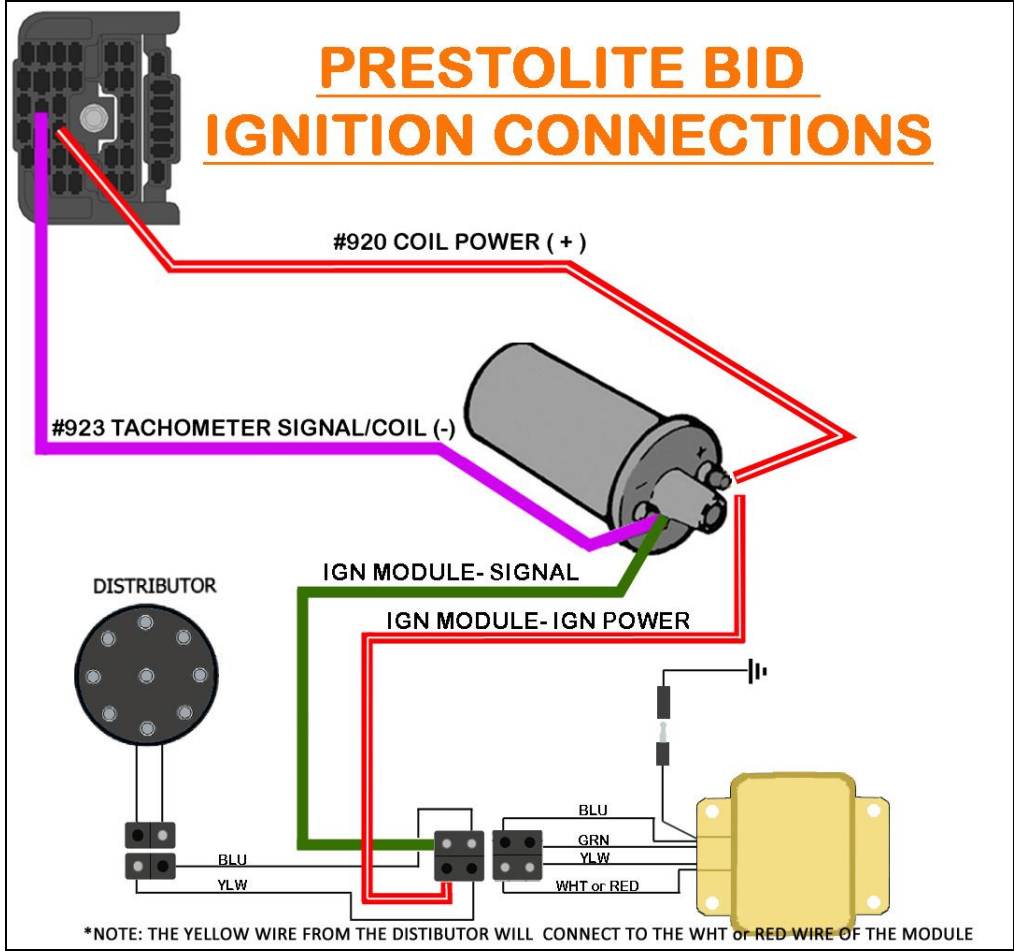
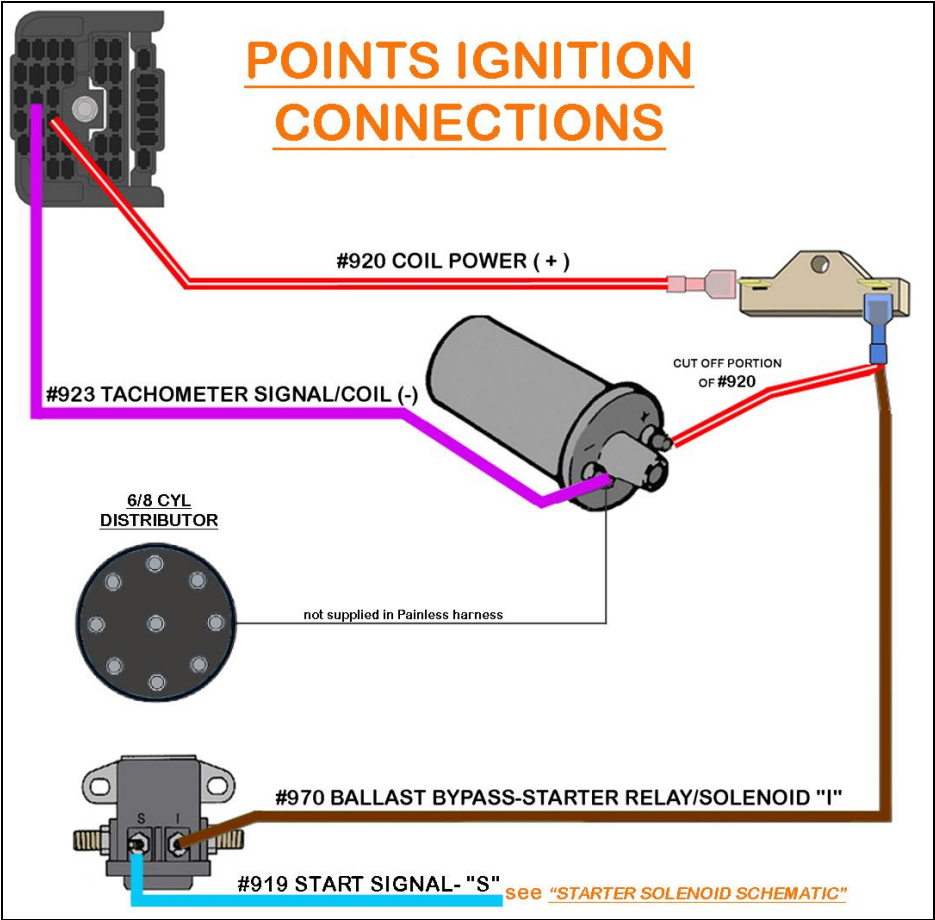

1980-1983 4 cyl HEI IGNITION

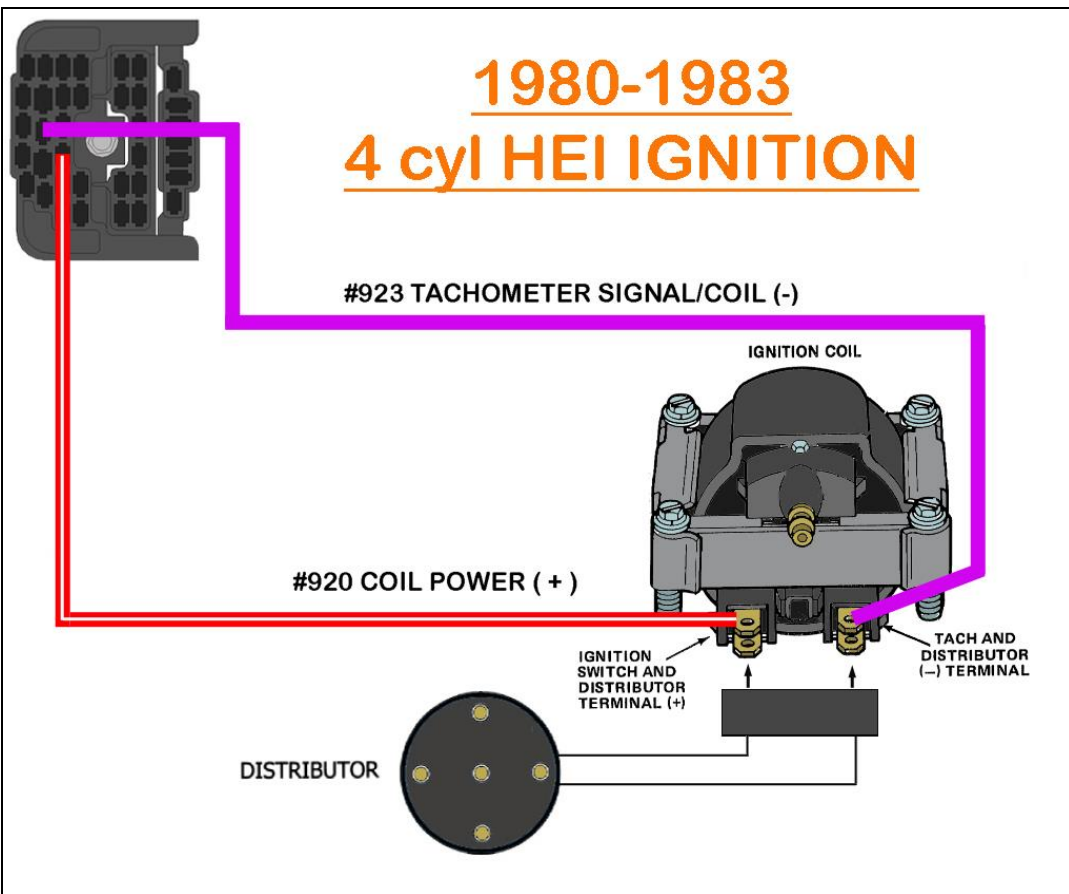

MSD IGNITION CONNECTIONS

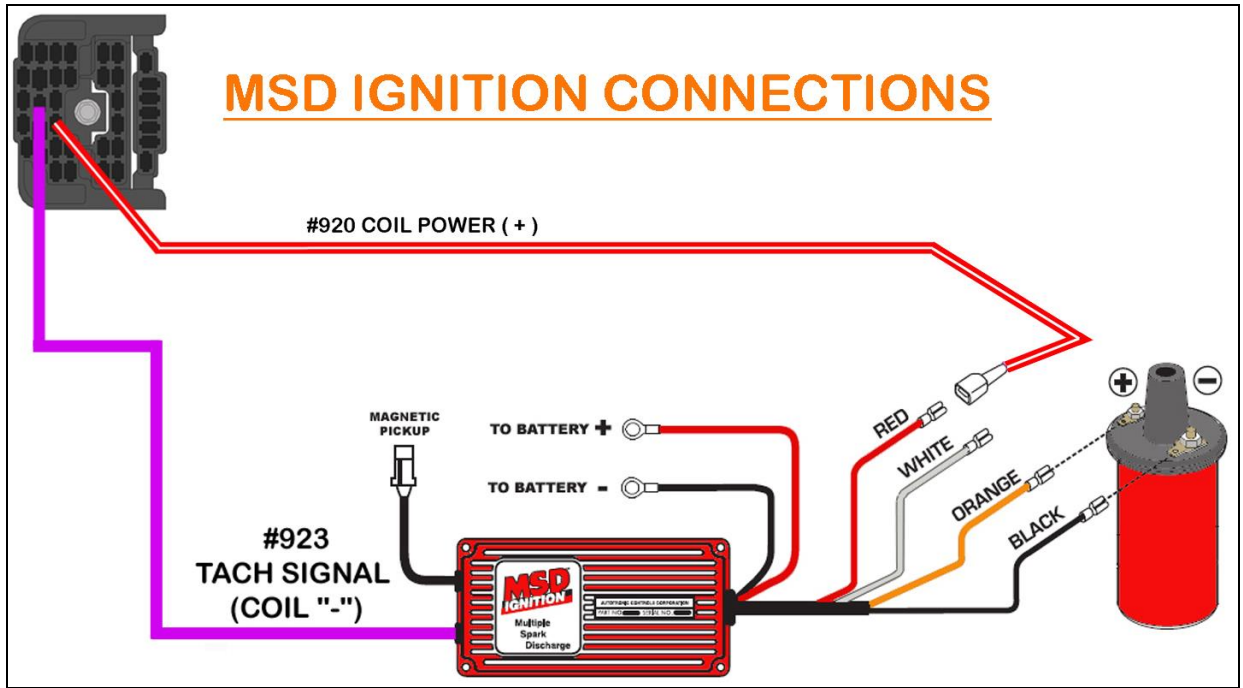

“ENGINE SECTION”

The engine section will contain wiring for the engine coolant temp sensor, oil pressure sending unit, power for an electric choke, and a wire for A/C compressor activation on models equipped with air conditioning.

Engine Sending Units/Switches

Jeeps with factory or aftermarket electric gauges, have sending units. The engine should have 2 gauge sending units; coolant temp and a oil pressure. If you are using aftermarket mechanical gauges, then no connections will need to be made. You can skip to the next connection, “**Electric Choke**” on page 105.

Sending units work based on resistance to ground. Meaning the cooler the engine or less oil pressure seen, the more ground (less resistance) these sending units will provide to the wire connected to them. As the ground resistance strengthens as the temps and/or pressure builds, less ground is applied to the gauge. As the ground signal weakens, the needle on the gauge moves to read higher temps and/or higher oil pressure. If you were to not connect these at all, the gauges would peg to their highest reading.

Coolant Temp



Locate the 18 gauge Purple/White wire printed **#921 ENGINE TEMP SENDING UNIT**. This wire will send a ground signal through the bulkhead into the interior of the Jeep to the gauge cluster. If you are using an aftermarket mechanical gauge, this wire will not be used. This wire will work with aftermarket electrical gauges and senders.

The coolant temp sending unit can usually be found in the intake manifold. This mounting will depend on the engine in the Jeep. This sending unit will have a threaded post to connect to, like the sensor seen in the photo located at the back driver side of this inline 6 cyl. **Do not get this sending unit confused with the temperature switch** for manifold heater operation, page 106.

If you are installing a new temp sensor, or are unsure of the temp sensor currently mounted in your engine, make sure there is no Teflon tape on the sensor threads. The tape could interfere with the ground source the sensor needs to read correctly.

- Route this purple/white **#921** wire to the coolant temp sensor, cut to length, install the appropriate terminal for your connection, and connect.



Oil Pressure

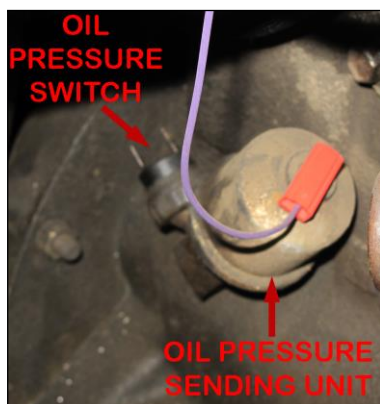

Locate the 18 gauge purple wire printed **#922 OIL PRESSURE SENDING UNIT**.

The **#922** wire will send a ground signal from the sending unit/switch through the bulkhead into the interior of the vehicle to the gauge cluster and to the aftermarket gauge connector.

The oil pressure sending unit will generally be located near the oil filter. **Do not get the oil pressure sending unit confused with the oil pressure switch**, both can be found next to one another. The oil pressure switch will be a two or three prong switch which is intended to interrupt the choke circuit, explained in the “Electric Choke” connection below.

- Route this PURPLE **#922** wire to the oil pressure sending unit, install the appropriate terminal for your connection, and connect.

Terminals and a factory style connector, seen in the photo to the right, have been supplied to allow connecting, “button” style sensor. Rollover crimpers will be needed to properly install this terminal.



Electric Choke

Locate the 18 gauge red wire printed **#954 ELECTRIC CHOKE POWER**. This wire will provide a switched ignition power source to the choke from the 15 amp “RADIO” fuse. This wire will have power when the ignition switch is in the ON/RUN position.

When you turn your key to the “ON/RUN” position, the voltage this wire carries will heat the bi-metal spring attached to the shaft of the choke. This spring will unravel as it is heated causing the choke to slowly open. When the ignition is turned to the “OFF” position, power is no longer on this wire, causing the spring to begin to cool and contract, closing the choke.

From the factory, the choke would only open when the engine had oil pressure, as in engine cranking or running conditions. This was done through the oil pressure switch, seen in the photo to the right and mounted in the picture at the top of the page. When the switch reads the appropriate amount of oil pressure, it closes or connects the two contacts.



- If you desire to run the choke like the factory did, route the **#954** to the oil pressure switch, cut to length, and install a pink colored heat shrinkable push on terminal from the parts kit. Once the heat shrink has been shrunk, connect the **#954** to one side of the oil pressure switch, it does not matter which side. This can be seen in the left side of the [Manifold Heater Relay Schematic](#) on the following page.
- Using the cut off piece of the **#954** wire, connect the other side of the oil pressure switch to the choke using the same push on terminals. Before this connection is made, see the “Manifold Heater Relay” instructions below as you may have another wire you may want to double up at the oil pressure switch or choke connection.
- Ensure the choke is properly grounded. A ground wire, not supplied in the Painless harness, may need to be connected if you have a carburetor with a negative or “-” tab.

Those with electric chokes who would rather bypass the oil pressure switch, or those with engines which were not a factory CJ option:

- Route the **#954** to the choke, cut to length and install a pink colored heat shrinkable push on terminal from the parts kit. Once the heat shrink has been shrunk, connect the **#954** to the choke.
- Ensure the choke is properly grounded. A ground wire, not supplied in the Painless harness, may need to be connected if you have a carburetor with a negative or “-” tab.

Manifold Heater Relay

The job of the manifold heater is to help vaporize fuel in the intake manifold when the engine is cold. This will help with cold starts and idling until the engine is up to operating temperature.

Due to lack of usage and the additional cost many would find unnecessary, wiring for the factory installed manifold heater relay is not provided. Painless does however offer a separate weather proof fused relay harness, specifically for manifold relay connection using this 10150 harness or a factory chassis harness, part [#30717](#).

For those not wanting to purchase [#30717](#), the original wiring will need to be reused. Using the diagram provided on the next page and the relay from the original harness, a new harness can be assembled by the installer using scrap wire cut from connections already made during the install of this 10150 harness. A connector and terminal, seen in the photo, have been provided to plug into the manifold heater connector, seen on the next page. A 30 amp circuit breaker or inline fuse will need to be sourced from a local auto parts store.

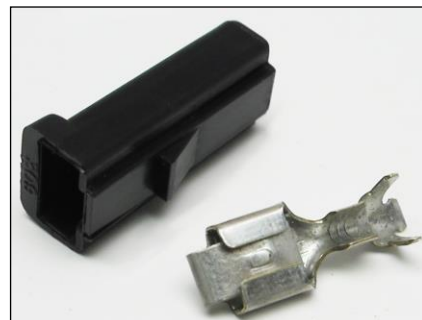

The only wire in the diagram on the following page provided by this 10150 harness is the **#954** wire.

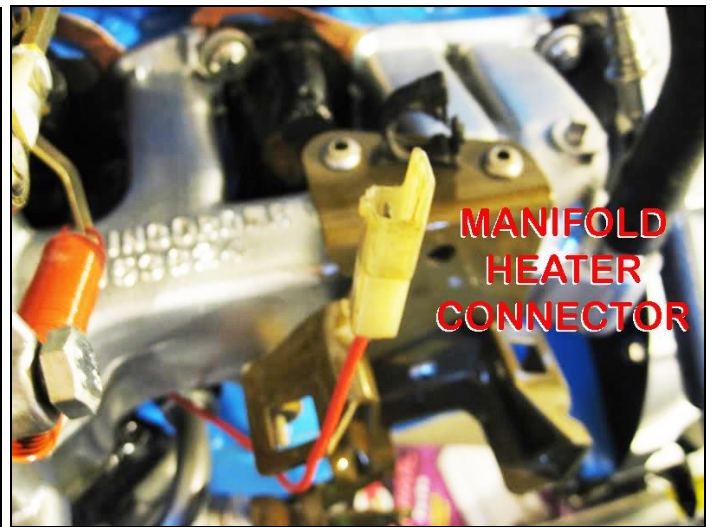
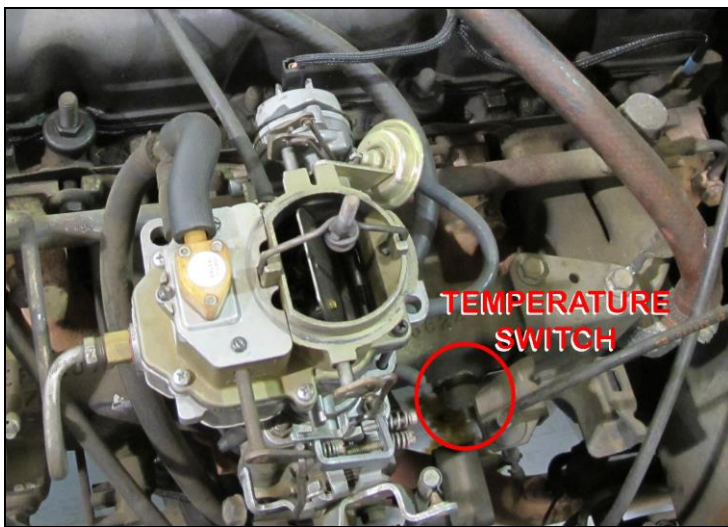
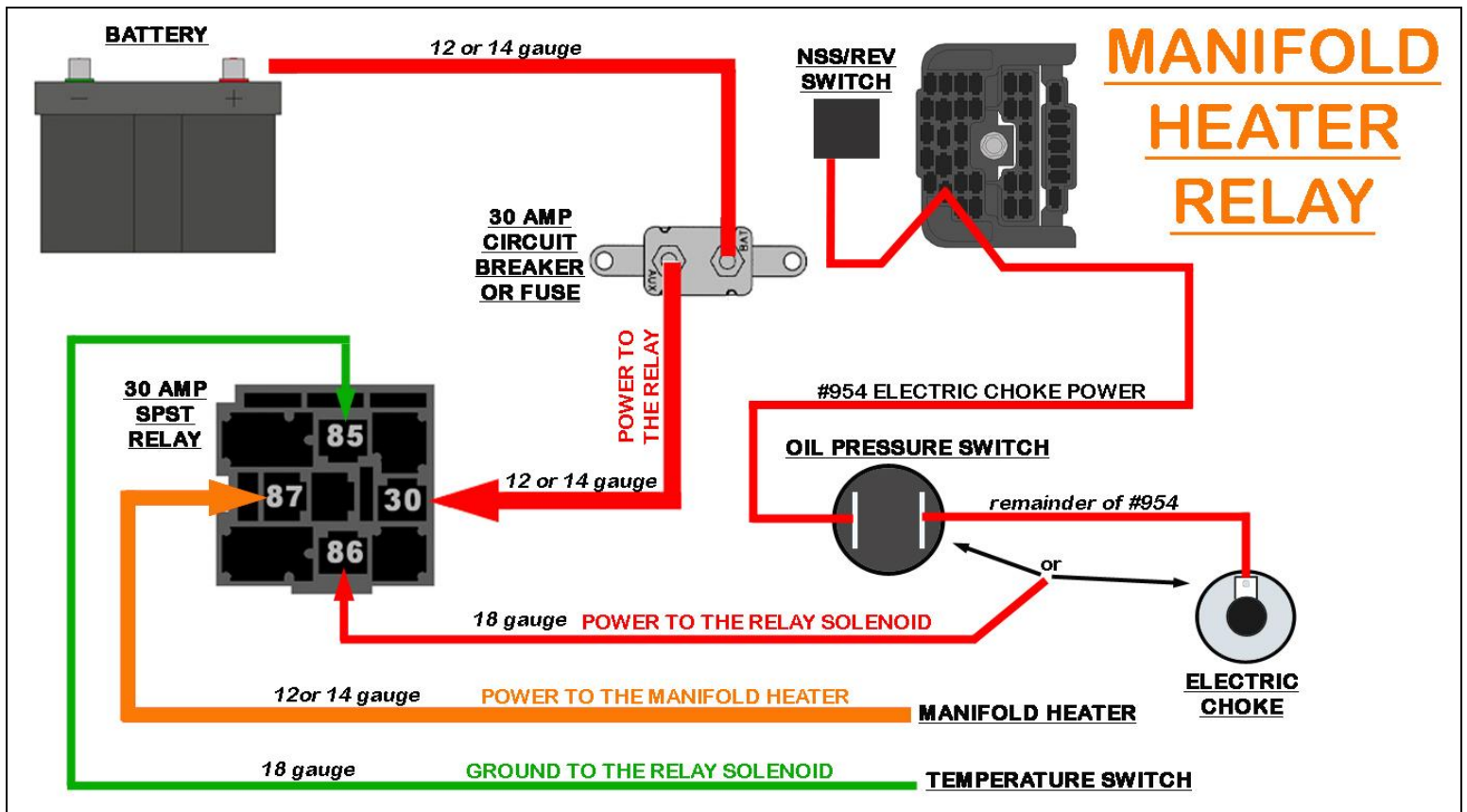

How the manifold heater relay works:

The manifold heater relay is activated by the smaller red wire coming from the 86 pin going to the choke power circuit.

The green wire, in the diagram above, coming from the 85 pin and going to the temperature switch will provide a ground signal to the relay. This temperature switch, found under the carburetor, is normally closed to ground, but as soon as it sees operating temperature, about 135 °F, the switch opens. This will disconnect the ground going to the relay, causing the relay to open. This will “open” the relay, disrupting the power going to the manifold heater since it is no longer needed because the intake manifold is at operating temperature.

A/C Compressor

A single wire is provided for those running factory or aftermarket air conditioning systems. This single wire carries switched ignition power from the air conditioning switch. This wire is:

Brown: 14 gauge wire, printed **#902 A/C COMPRESSOR ACTIVATION**, this wire will have power when properly connected to an air conditioning switch, and the switch is in the “ON” position.

- Connect this wire to one side of the low freon switch. Using the cut off remainder to this **#902** wire, connect the other side of the low freon switch to the wire on the A/C compressor.

Insulated push on terminals and an insulated socket terminal have been provided in the parts kit to allow for connection at the freon switch and the compressor.

“Alternator”

The alternator connections will vary depending on the alternator your vehicle currently has installed. The alternator may also need to be removed in order to gain access to the connection points.

- Before removing the alternator from the accessory bracket, read through all of the alternator instructions on the next few pages. This will allow you to route the alternator wires you will need for your particular installation to their connection points and cut to length before removal of the alternator.

Locate the bag kit provided with the Painless harness labeled “ALTERNATOR”. This bag kit will contain hardware needed to make the appropriate connections to the alternator and also contains a covered inline fuse holder.



Locate the three wires intended for alternator connections; two will be in the small group of wires labeled “ALTERNATOR” on the engine harness. These wires are:

Red: 14 gauge wire, printed **#995 REGULATOR BATTERY POWER**, this wire will provide a battery power source, or amperage sample that some voltage regulators require. This wire will have power at all times and comes from the large battery supply splice in the harness. **This wire will not be needed if you have a one wire alternator or any of the CS series alternators.** See [Battery Power Schematic](#) on page 119.

Brown: 16 gauge brown wire, printed **#914 ALTERNATOR EXCITER**, this wire will have switched ignition power. In the event you have a one wire alternator, nothing will be done to the connectors, and there will be no power on this wire. **This wire will not be needed if you have a one wire alternator.**

The third wire required is a large 6 gauge wire, provided with this kit, but not part of the engine harness. This wire is

Red: 6 gauge wire, with a label printed **#915 ALTERNATOR OUTPUT**, this wire will provide power out of the alternator to the chassis harness and back to the battery through the MIDI fuse. This wire will have power at all times and comes from the large battery supply splice in the harness. See [Battery Power Schematic](#) on page 119.

The one connection all alternators will have in common is the output post. This will send amperage from the alternator to the battery. This connection will be made using the large 6 gauge **#915** wire.

- Locate the rubber alternator boot and a large un-insulated ring terminal from the "ALTERNATOR" bag that has the right size opening for your alternator post. The piece of red heat shrink may be used along with the boot or just by itself over the terminal crimp if the alternator boot is not desired.
- If the heat shrink is being used, slide it onto the **#915** wire, followed by the rubber boot. A very small amount of lubricant like WD-40 may be applied on the inside of the rubber boot to allow the boot to slide down the wire easier.
- With the boot on, strip about ¼" of insulation from the charge wire and crimp the ring terminal on. You can use a pair of pliers if your crimpers will not accept this large gauge wire/terminal.
- Connect this wire to the B+/Output stud on the Alternator. Once the nut is on the stud on the output post has been tightened, the boot can now be slid up the wire to cover the nut and ring terminal installed on the Alternator. The heat shrink can be slid over the end of the boot and shrunk down.



Be advised this heat shrink will have to be removed before the rubber boot can slide back down the wire if the charge wire is ever to be removed.

If your vehicle has an aftermarket **one wire** alternator or if the Painless or other aftermarket fuel injection harness you are using has an alternator connector, then this output wire is the only wire used to make the alternator connection. The two remaining wires, a 14 gauge red wire printed **#995 REGULATOR BATTERY POWER SAMPLE** and a 16 gauge brown wire labeled **#914 ALTERNATOR EXCITER**, can be removed from the harness. **#995** may be connected to the output post of the alternator to avoid removing it from the harness since this wire goes into the battery power splice.

INSULATE ANY UNUSED WIRES.

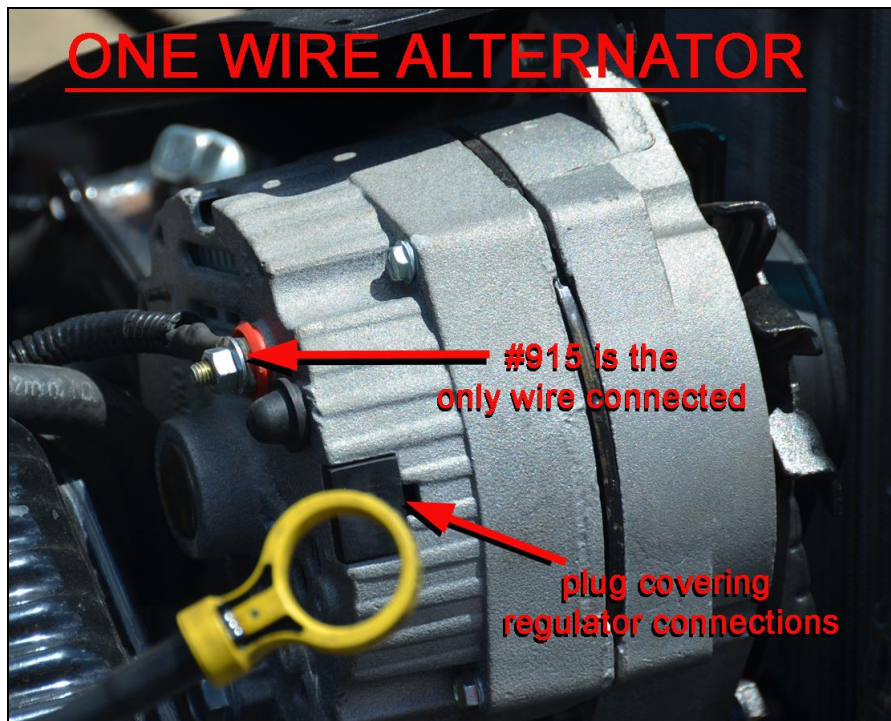

“DELCO” SI Series Alternators

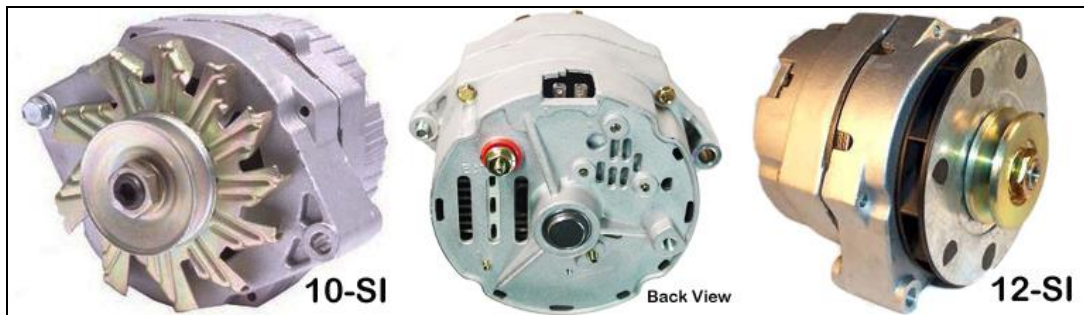

The GM 10-SI and 12-SI alternators are easy to identify. They will have an external fan behind the pulley, the 12-SI having enclosed style fan blades, and a two pin connection. This 2 pin connection can be seen on the middle image in the diagram above. These are also known as “Delco” or “Delcotron” alternators.

The two remaining wires, a 14 gauge red wire printed **#995 REGULATOR BATTERY POWER SAMPLE** and a 16 gauge brown wire labeled **#914 ALTERNATOR EXCITER**, will connect to the two posts on the back edge of the alternator.

- Route the two wires to the 1 & 2 terminals on the alternator and cut to length. Strip $\frac{1}{4}$ " of insulation from both wires.
- A factory style connector and terminals, seen in the photo, have been provided in the “ALTERNATOR” bag. Crimp a terminal onto each of the two wires.



- Insert the wires into the connector as shown in the diagram below. When terminal pin-out is complete, plug the connector into the alternator.

In some installs, you may experience engine run on. This is caused when the alternator back feeds voltage down the #914 wire after the key has been turned off. This allows the ignition system to still function causing the engine to continue running even though the key is turned off or even removed from the ignition. If this should happen unplug the alternator connector to shut the engine off. Installing a diode is a simple fix. When the diode is installed inline of the #914 wire with the stripe towards the alternator, as shown in the diagram on the previous page, the diode will let voltage flow towards the alternator, but not away from the alternator towards the ignition system.

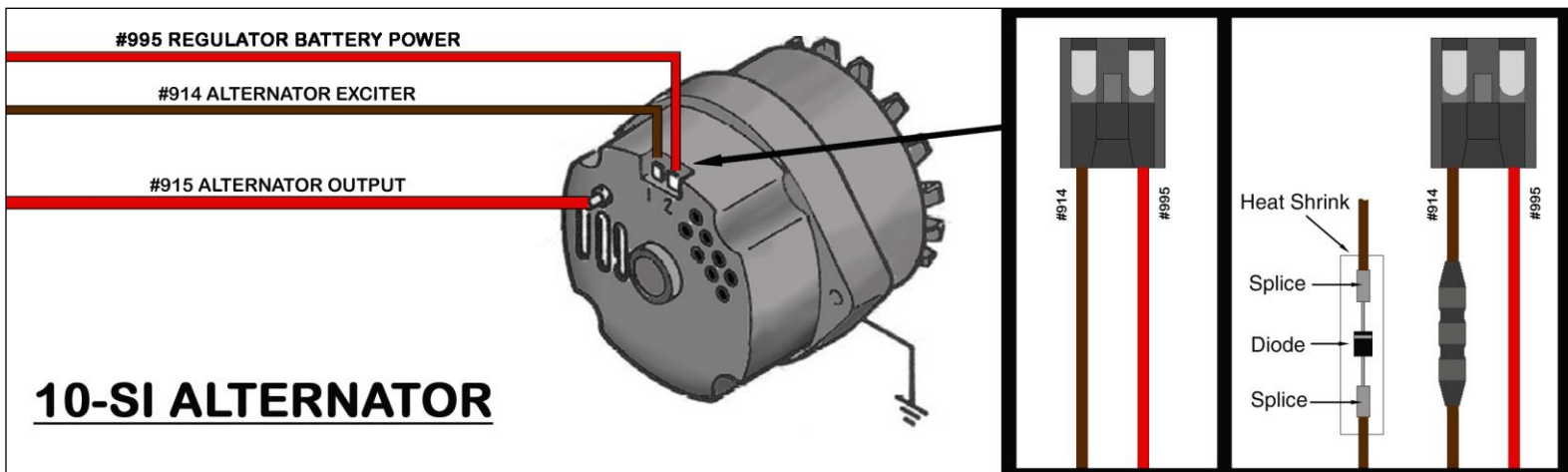

CS-130, CS-121, CS-144 Series Alternators



The GM CS-130, CS-121 and CS-144 alternators closely resemble the SI series alternators. They will have an external fan behind the pulley and they generally have some plastic casing on the side and back. These alternators have a four pin sealed connector, seen in the photo below and in the middle image above. The regulator will be marked P,L,S,F. This type of alternator was used on GM TPI and LT1 fuel injected engines among other late 1980's to mid 1990's GM vehicles.

The two remaining wires, a 14 gauge red wire printed **#995 REGULATOR BATTERY POWER SAMPLE** and a 16 gauge brown wire labeled **#914 ALTERNATOR EXCITER**, will connect to the regulator on the back of the alternator.

- Route the two wires to the connector on the alternator and cut to length. Strip ¼" of insulation from both wires.

- The 4-pin alternator connector from the harness removed from the vehicle prior to installation of this Painless harness (see photo), will need to be used.
- The CS-130 alternator requires a resistance on the **#914** wire. Without this resistance the regulator will burn up. An 82-ohm resistor, splices, and heat shrink, seen below, have been provided in the "ALTERNATOR" bag kit. The resistor* will simply need to be installed inline on the **#914** wire as shown in the diagram on the next page.

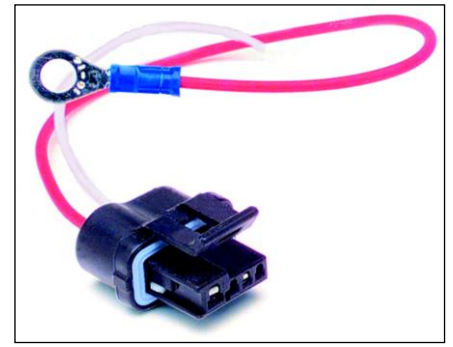

*In factory applications where this alternator was used this resistance was created through a charge indicator light.

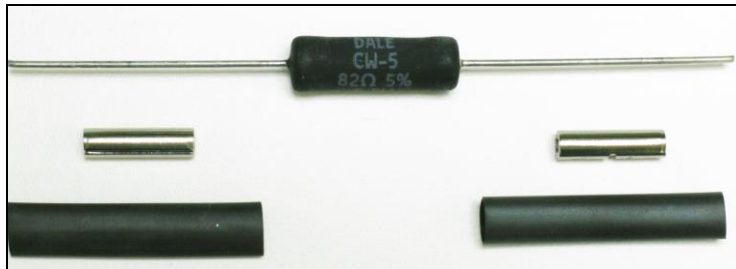

- Using splices and heat shrink provided in the "ALTERNATOR" bag kit, splice the CS-130 pigtail to the **#914** and **#995** wires according to the diagram below. This diagram also represents CS-121 and CS-144 alternators

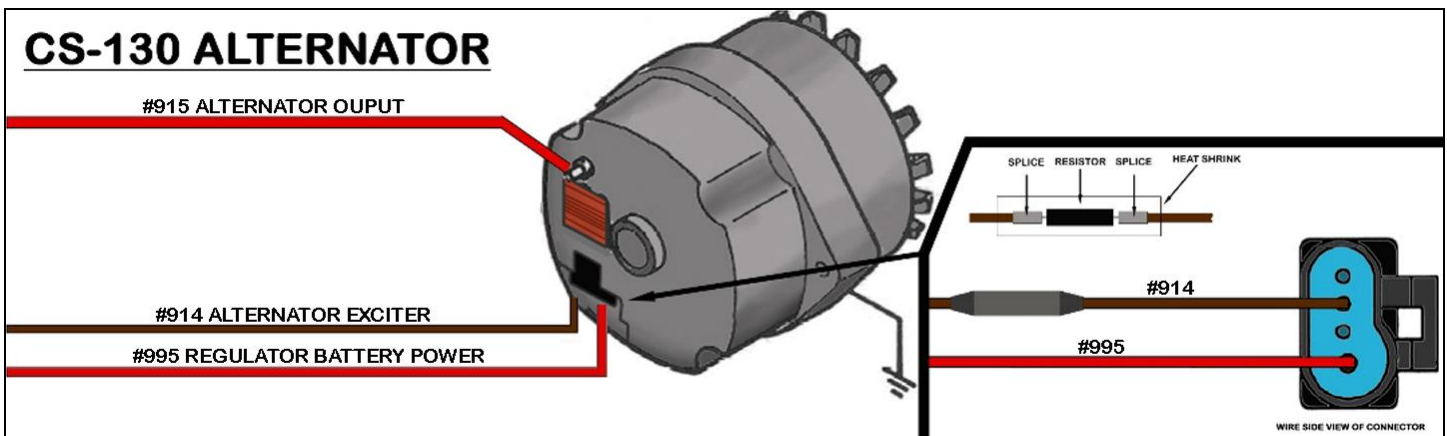

CS-130D Series Alternators

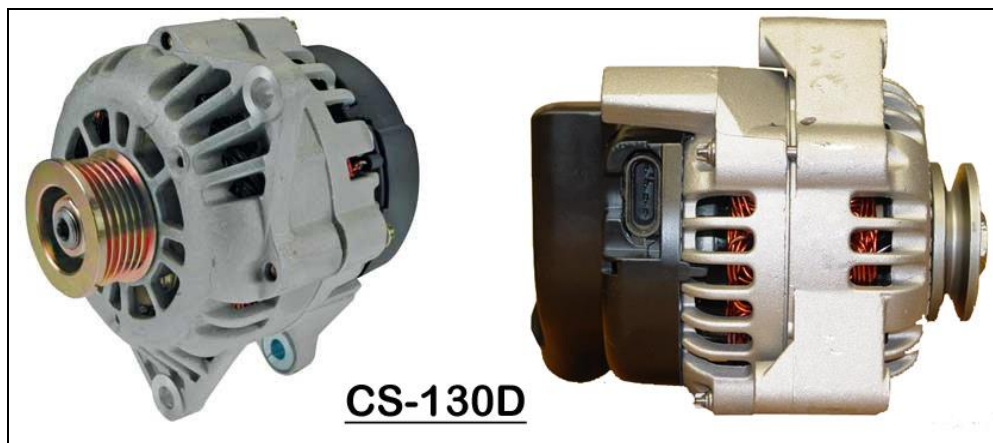

The GM CS-130D can be spotted by their lack of an external fan behind the pulley. These alternators have an internal fan. They also have a plastic casing on the back. These alternators have an elongated oval, four pin sealed connector, seen in the image above. The regulator will be marked P,L,I,S. This type of alternator was used on many engines, including the GM LS series, Vortec and Gen. III Vortec truck fuel injected engines.

Of the two remaining wires, a 14 gauge red wire printed **#995 REGULATOR BATTERY POWER SAMPLE** and a 16 gauge brown wire labeled **#914 ALTERNATOR EXCITER**, only the **#914** will be used. The **#995** may be connected to the alternator output post or removed from the harness.

- Route the brown **#914** to the connector on the alternator and cut to length. Strip ¼" of insulation.
- The four pin alternator connector from the harness removed from the vehicle prior to installation of the Painless harness or a CS-130D pigtail purchased from Painless, [part # 30708](#) (see photo), will need to be used.
- The CS-130D alternator requires a switched power source to pin "I" of the regulator, and a resistance on the wire going to pin "L" of the regulator, the brown wire in the photo above. Without this resistance the regulator on the alternator will burn up. An 82 ohm resistor, splices, and heat shrink, seen below, have been provided in the "ALTERNATOR" bag kit. The resistor* will simply need to be installed inline on the "L" pin wire as shown in the diagrams on the next page.

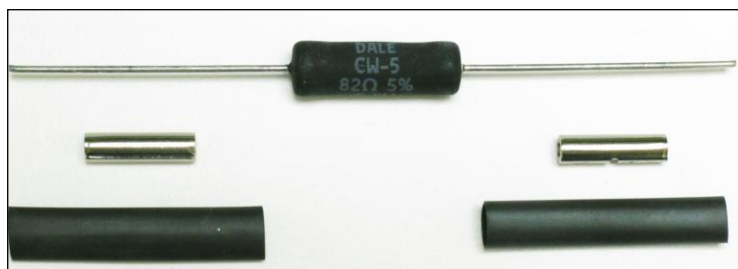

*In factory applications where this alternator was used this resistance was created through a charge indicator light.

- Using a splice and heat shrink provided in the “ALTERNATOR” bag kit, splice the CS-130D pigtail to the brown #914 wire according to the diagrams below.

Both diagrams accomplish the same task, using the brown #914 ALTERNATOR EXCITER wire to provide a switched power source and a resisted power source to the 2 wires of a CS-130D alternator pigtail/connector. Pick the method that easiest for you to understand.

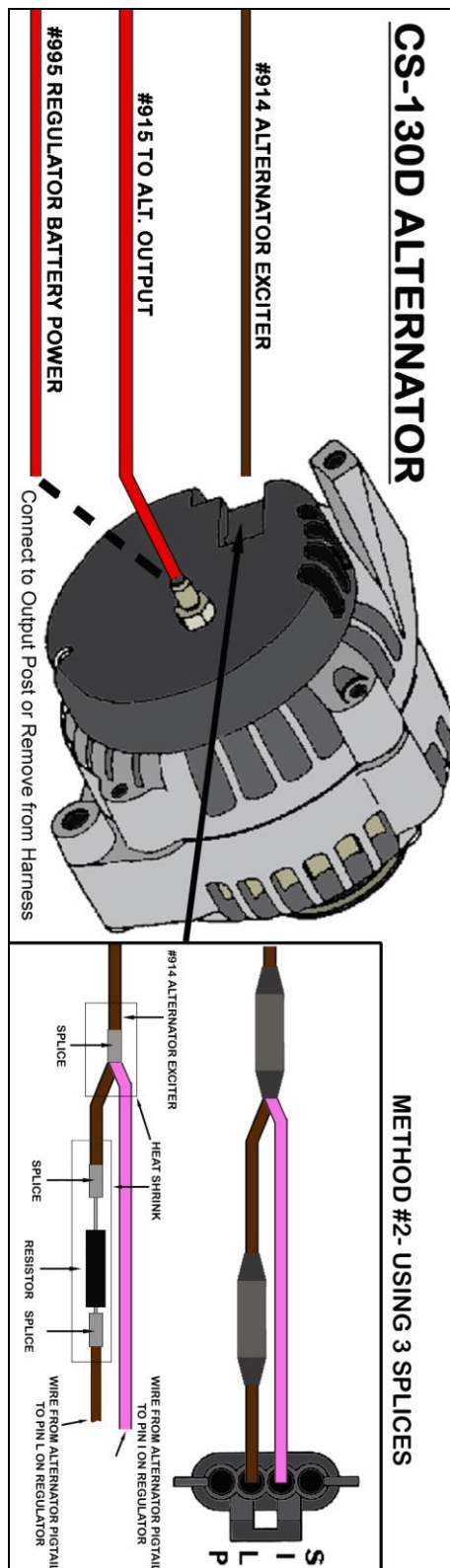
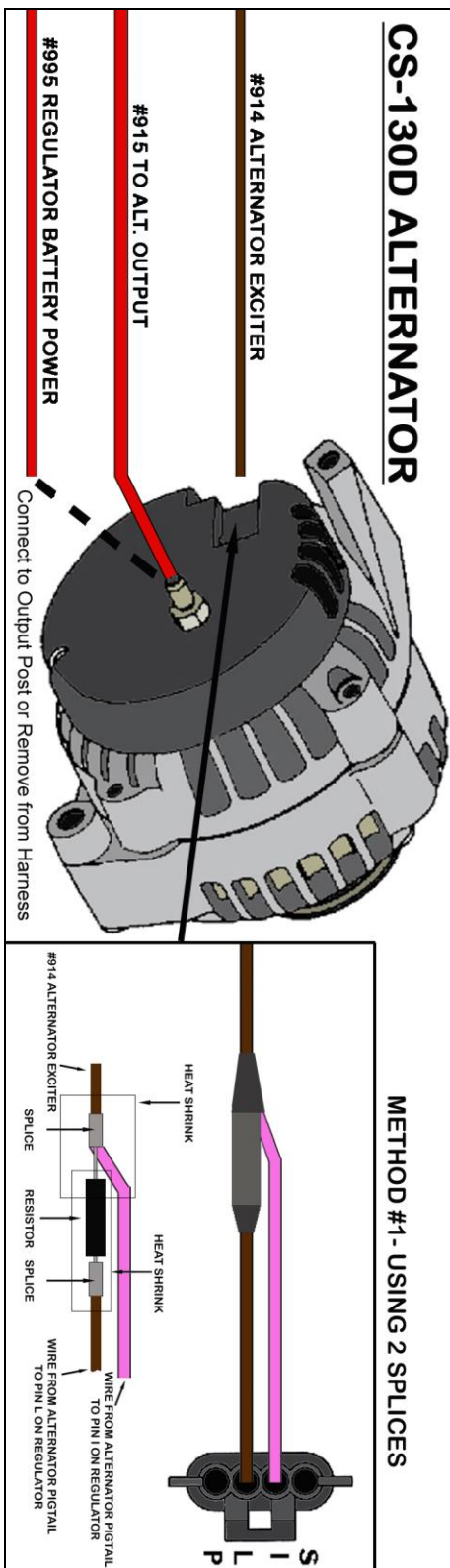

Externally Regulated Motorcraft Alternators

The four pin regulator connector from the harness removed from the vehicle prior to installation of the Painless will need to be used. Due to a lack of usage by most customers this connector is not included with this Painless chassis harness. If you do not have this connector and they can be obtained online or at a local auto parts store by searching for a regulator connector for a Jeep Cj or for a late 1960's to mid 1970's Ford car/truck. You can also simply use the loose piece insulated terminals in the parts kit to make connections.

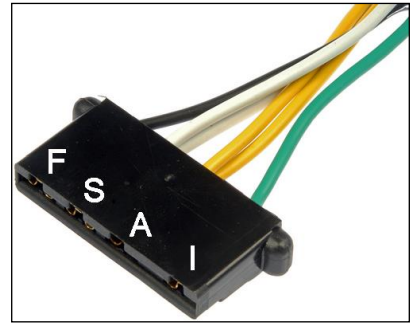

Terminals have been provided that will fit this connector, seen in the photo to the right. This will allow you to make a factory style connection.

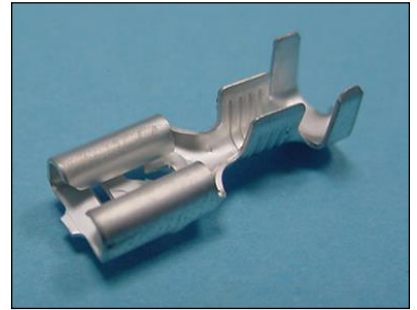

The factory terminals in the connectors have a locking tang that keeps them from being pulled out from the connector. This tang can be seen in the photo to the right, or can be seen by examining one of the factory style terminals from the parts kit. In order to remove the terminal from the connector, the tang must be flattened down and the terminal pulled from the connector.



- Looking at the switch side of the connector you will notice little openings above or below the terminals. This little opening gives you access to the locking tang on the terminal. The regulator will have openings like the ones seen on the connector in the photo below.
- Insert a small pick, a paper clip, or a thin piece of stiff wire into this opening. Apply a slight amount of pressure to make sure you are as far into the connector as you can go.
- As the pick/paper clip is being pushed into the opening, pull the wire from the opposite side of the connector to remove the wire from its location.



Reusing factory connector:

- Remove the wires from the connector that connect to pins "S" and "A" on the regulator. On a factory CJ connector these will be black (pin "S") and yellow (pin "A") wires.

If the wire for pin "F", green wire, is still in good condition this wire can remain in the connector, if you would like to replace it, remove it from the connector.

New Connector:

- Remove all the wires from the connector. Terminals, as seen on the previous page, have been provided to install the wires from the Painless harness into the connector.

The two remaining wires, a 14 gauge red wire printed **#995 ALTERNATOR BATTERY POWER SAMPLE** and a 16 gauge brown wire labeled **#914 ALTERNATOR EXCITER**, will connect to the regulator.

- Route the two wires of the Painless harness to the connection point on the regulator and cut to length. Strip $\frac{1}{4}$ " of insulation from both wires. Install an insulated push on terminal onto each of the wires if you do not have a regulator connector. If you have a connector, install one of the factory style terminals, seen on the previous page, onto each wire.

Use the [Motorcraft Alternator Diagram](#), below, to make the correct connections.

- Connect or insert the brown **#914** wire to the "S" terminal on the regulator or regulator connector.
- Connect or insert the red **#995** to the "A" terminal on the regulator or regulator connector.

A 14 gauge wire will need to be provided by the installer to finish the connections. This wire is not in the Painless harness.

- Connect the "F" terminal on the regulator to the "FLD" terminal on the alternator. This was a green wire from the factory.

The "I" terminal of the regulator will not have anything connected to it.

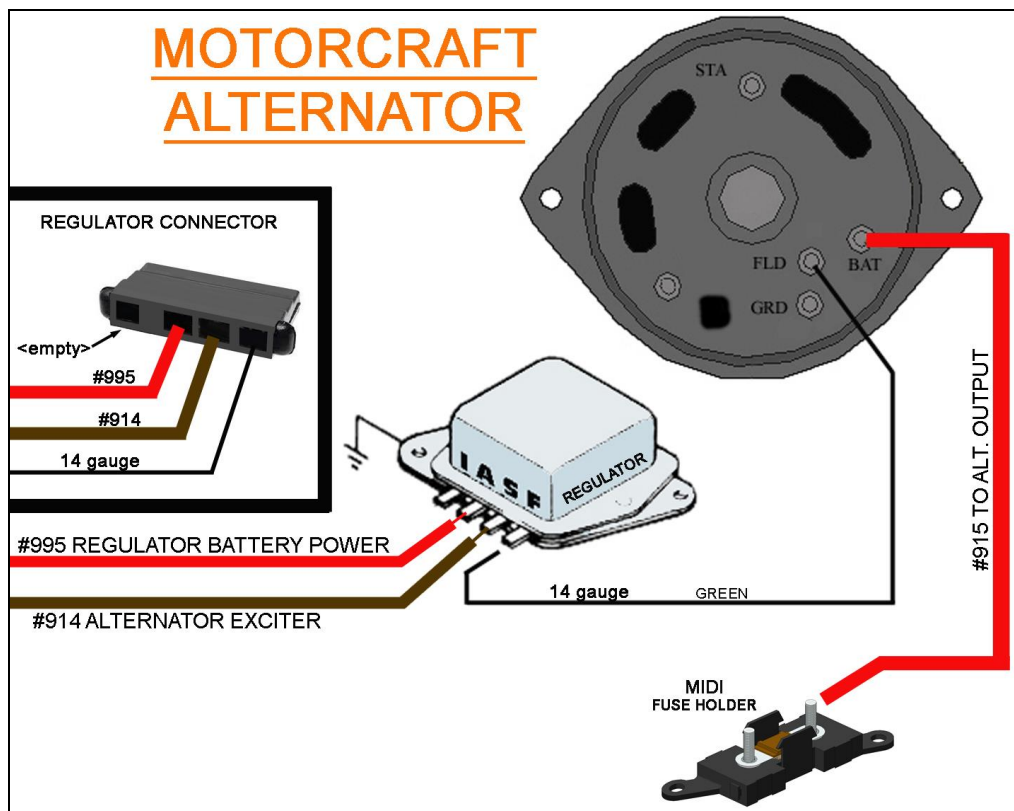

“Blower Motor”

2 Speed- Your blower motor connections were done on the inside of the Jeep, page 80, and this connection will not be needed and may be removed from the harness. You may skip to the “GROUND” connection below.

3 Speed- A single wire with a black connector labeled “BLOWER MOTOR” will be the next connection. This will be a wire that will connect to the blower motor, found on the passenger side firewall, below the factory battery location. Removal of the battery and battery tray may be necessary for you to make this connection. The wire that will connect to the blower motor will be:

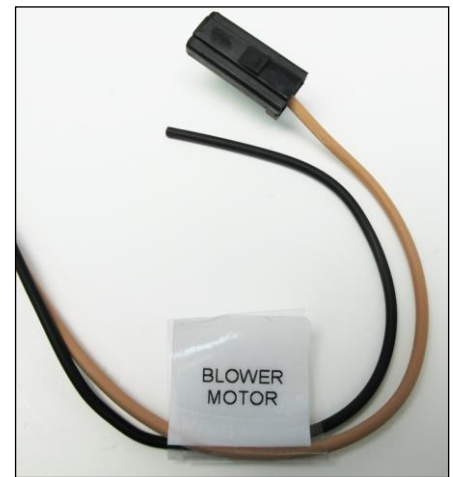

Tan: 14 gauge wire, printed **#967 BLOWER MOTOR POWER**, this wire will supply switched ignition power to the blower motor from the blower motor switch on the dash.

A second wire that is open ended without a connector is also provided with this power wire. It is:

Black: 14 gauge wire, printed **#969 BLOWER MOTOR GROUND**, this wire will provide a ground source to the blower motor for those with a fiberglass body. This wire is part of the integrated ground circuit of the Painless harness. This wire can be seen in the [Ground Schematic](#) on page 13.

- Route the tan **#967** power wire to the tab on the blower motor and connect.
- If the blower motor requires a clean ground source, route the **#969** wire to one of the firewall mounting bolts found near the blower motor. These bolts hold the blower motor housing/panel to the firewall. Connect using a ring terminal from the parts kit.
- Once the blower motor has been connected, Reinstall the battery tray and battery, **but do not connect any battery cables at this time.**



“Ground”

A single open ended wire with a section label reading “GROUND” can be found in the same breakout out the blower motor connections. This wire is intended to route to the battery; it is:

Black: 10 gauge wire, printed **#969 BATTERY - (GROUND FOR HARNESS)**, this wire will provide the chassis ground source for the entire integrated ground circuit in this chassis harness.



- Route this **#969** wire to the battery lug on the negative battery cable. This can be at the battery or where the cable connects to the frame or engine.
- Cut to length and using a ring terminal supplied in the parts kit connect. **Do not connect anything directly to the battery at this time.**



“MIDI Fuse”

This is not a section of the harness; this is an in line MIDI fuse holder that has been included in the “Alternator” bag kit. This inline fuse will provide a fused link between the alternator and battery and the chassis harness and battery.

- Find a suitable location to mount the supplied fuse holder using the two screws provided. Try to mount it near the battery or starter solenoid. A ¼” nut driver and drill will be needed in order to mount the fuse holder.



With the fuse holder now mounted locate the red 6 gauge charge wire with the label reading **#915 TO ALT. OUTPUT**. The other end of this wire was connected to the alternator output lug on page 109.

- Route the large **#915** wire to one side of the fuse holder and cut the wire to length. **DO NOT DISCARD THE CUT OFF PORTION OF #915.**

The length of excess wire cut from the **#915** wire will be used to connect the other side of the fuse to the “+” side of the vehicle’s battery or to the battery post on the starter solenoid. **DO NOT CONNECT THE #915 TO THE ACTUAL BATTERY AT THIS TIME.** If routed to the starter solenoid, this wire will NOT replace the battery cable needed by the starter from the positive side of the battery to the “BAT” or “+” post of the starter solenoid.

- Connection to both sides of the fuse holder will be made using the large ring terminals with the small #10 hole provided with the kit. You can carefully use a pair of pliers if your crimpers will not accept this large gauge wire/terminal. The heat shrink supplied with this kit is intended to cover the crimped end of each of these two ring terminals. A schematic showing these connections can be found on the next page.

Remember to route the remaining end of #915 to either the battery lug or the starter solenoid.

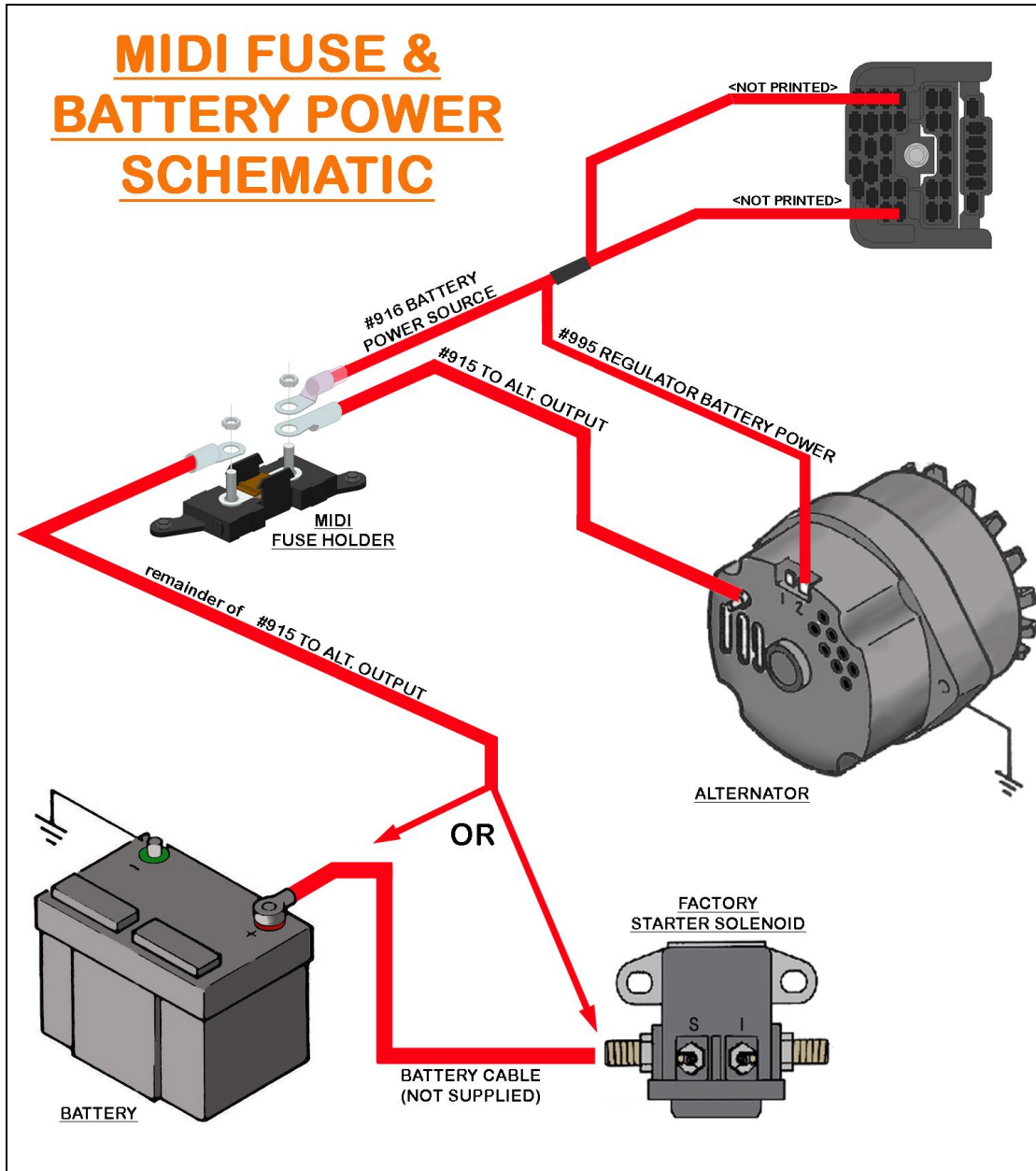

NOTES:

“Starter Solenoid”

In this section you will find wires that will connect to the starter solenoid or starter relay. Connections in this section include: harness power, start signal, NSS ground, and chassis ground. Connections of these wires will depend on your use of a factory style “Ford” inner fender mounted starter solenoid, a starter relay used with SR 14 automatic transmissions, or a starter mounted solenoid as in that case of those CJ’s now equipped with a GM/Chevrolet engine that may have been swapped in.

Harness power

Locate the large gauge red wire. This wire will actually connect to the inline MIDI fuse and not directly to the starter solenoid. This wire is:

Red: 8 gauge wire, printed **#916 BATTERY POWER SOURCE**, this wire will feed the harness battery power. This wire can be seen [Battery Power Schematic](#) on the previous page.

- Route this wire to the alternator side of the MIDI fuse and cut to length.

If you have a “SR 14” starter relay, route this wire to the “B+” terminal on the relay, and connect to the BAT lug as seen on page 121. Use the remainder of **#916** to connect the lug to the MIDI fuse.

- Using the large barreled light pink colored insulated ring terminal from the “ALTERNATOR” bag, connect the **#916** wire to the MIDI fuse. This ring terminal is heat shrinkable.
- At this time, all connections have been made to the MIDI fuse. The other connections were made on page 115. Ensure the 100 amp fuse has been installed and secure each of the 2 nuts on each threaded stud using a 5/16 socket. Once tightened, the protective rubber cap can be pressed into place on the cover.

Factory Remote Starter Solenoid Mounting

Most CJ’s have a remote “Ford” style starter solenoid mounted to the passenger side inner fender. In order for this solenoid to work properly it must be grounded. This can be an issue for newly painted or extremely dirty/greasy engine compartments as this ground comes through the mounting of the solenoid. Ground for the solenoid can be done in one of two ways:

- #1) Cleaning/sanding the area around the mounting holes to ensure the metal mounting tab of the solenoid makes a good contact with the metal of the inner fender. This will give the solenoid a great path to chassis ground, as seen in the photo on the next page.



- #2) If you would rather not sand or mar your newly painted inner fender, a ground wire has been provided, this wire is:

Black: 16 gauge wire, printed **#969 STARTER SOLENOID GROUND**, this wire will provide a ground source to the starter solenoid. This wire is part of the integrated ground circuit of the Painless harness. This wire can be seen in the [Ground Schematic](#) on page 13.

- Using a ring terminal from the parts kit, connect this **#969** wire to one of the mounting bolts that hold the starter solenoid to the inner fender.

Start Signal

A light blue wire can be found in the “Starter Solenoid” section. This wire is the start signal wire from the ignition switch, this wire also passes through a neutral safety switch. This wire is:

Light Blue: 14 gauge wire, printed **#919 START SIGNAL- "S"**, this wire carries a switched ignition power source to the “S” terminal of the starter solenoid or starter relay. This wire will only have power when the ignition switch is in the “START” position and the transmission is in park or neutral. This wire can be seen in the [Starter Schematics](#) beginning on page 123.

- Route the light blue **#919** to the “S” terminal of the starter solenoid or the “I” terminal or a “SR14” starter relay.

If a Duraspark ignition system is being used, route the **IGN MODULE-CRANK SIGNAL** to the “S” terminal as well. This **IGN MODULE...** wire can be seen in the [Duraspark Ignition Schematic](#) on page 102.

- Locate a heat shrinkable ring terminal or the push on terminal from the parts kit that best fit the posts found on the starter solenoid and install onto the “S” terminal of the solenoid or “I” terminal of the starter relay. Be sure to apply heat to shrink the insulation to protect the crimp.

- If you are using a SR 14 relay, use the remainder of the #919 wire to connect the “SOL” terminal on the relay to the “S” stud on the starter. As seen in the diagram on page 124.

“SR 14” Relay

Those who have a factory starter relay, seen in the photo, will need a ground wire to allow the relay to power the starter solenoid when the transmission is in park or neutral. This wire is provided in this Painless harness, it is:



Black: 16 gauge wire, printed #998 NSS TO STARTER RELAY GROUND, this wire will provide the relay with the required ground source to allow the relay to work correctly. This wire will provide ground from the three wire transmission mounted neutral safety/reverse switch, as shown on page 93 and 94.

- Route the black #998 to the “G” terminal of the “SR 14” starter relay and connect using an insulated push on terminal from the parts kit.

The #998 wire will only be used with this starter relay, if you have a remote mounted “Ford” solenoid or a GM starter, the #998 will not be used.

Ballast Bypass

Those using points or a Duraspark ignition will need to connect the other end of the brown #970 ballast bypass wire, previously connected to the ignition system on page 96. The #970 will connect to the “I” terminal of the starter solenoid or to the “BAL” terminal of a SR 14 starter relay. Diagrams have been provided to show this wire, please be aware that if you are using an aftermarket electronic ignition, HEI, or any other ignition system that does not require a ballast resistor, then this wire is not needed.

The #970 is not part of the starter solenoid wiring in the harness; it is found in the bag of wires labeled “IGNITION MODULE” provided with the kit. This wire will only be needed with ignitions that require the use of the supplied ballast resistor.

NOTES:

FACTORY "FORD" STARTER SOLENOID

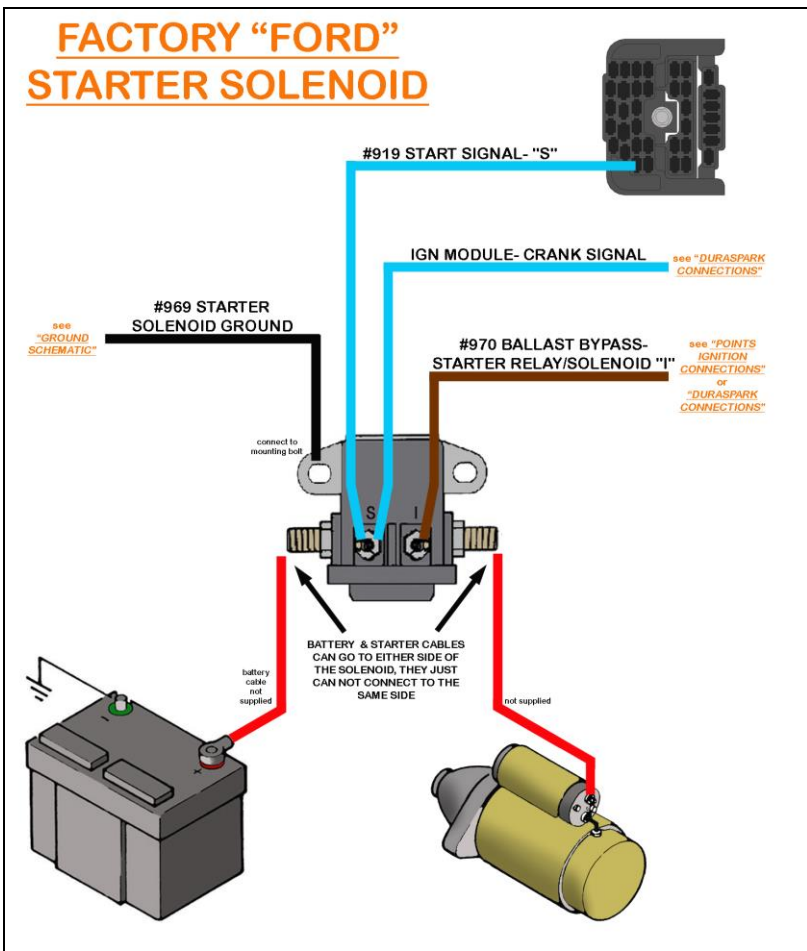

GM STARTER SOLENOID CONNECTIONS

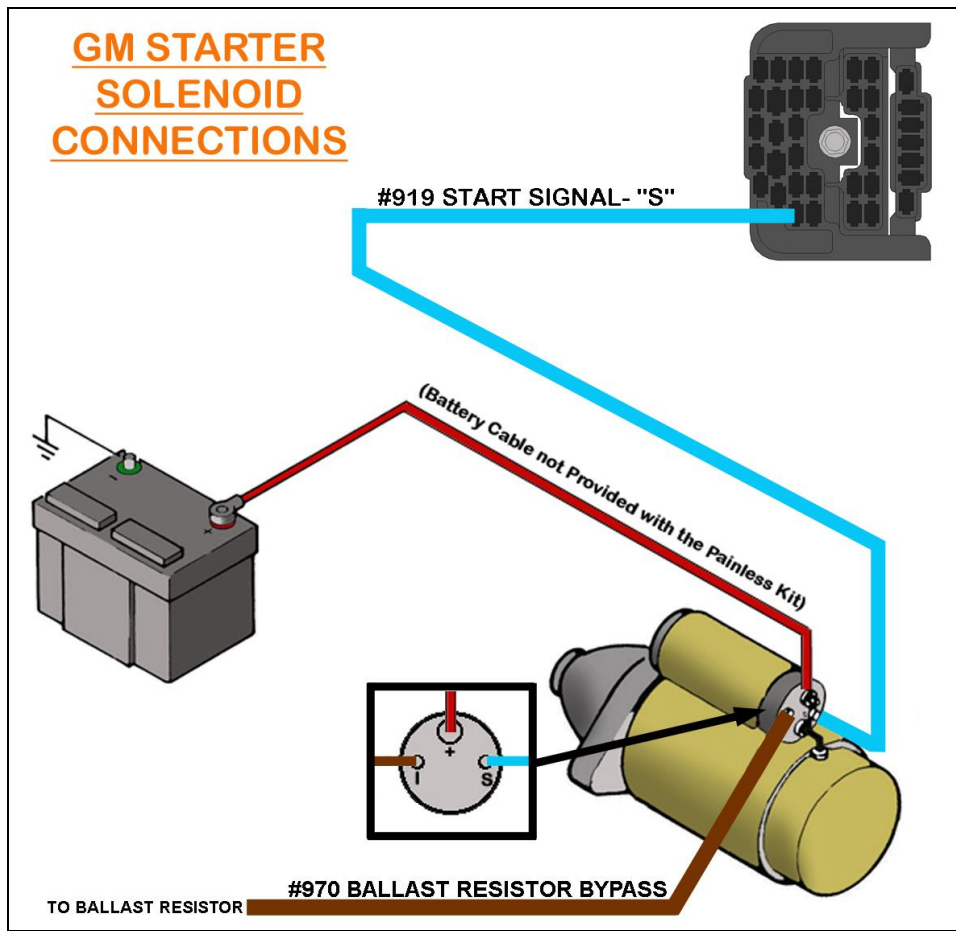

SR14 STARTER RELAY

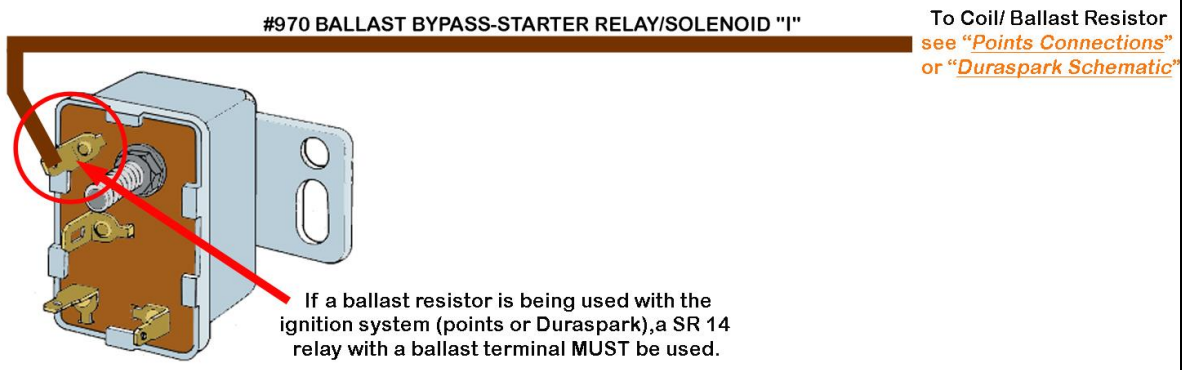
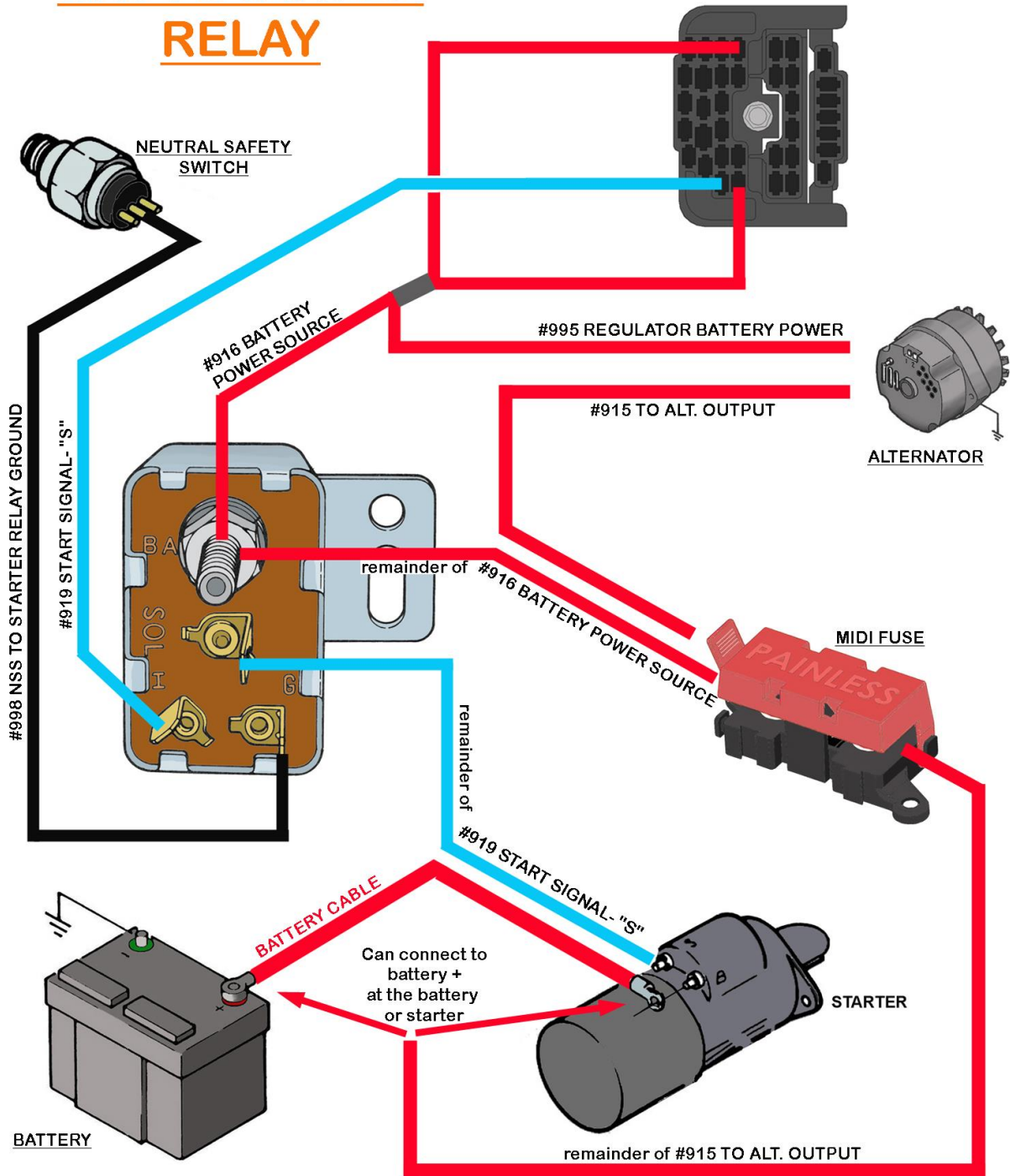

“ACC Relay”

This is the last group of wires in the engine harness. These two wires will provide power and ground to a component or for activation of a relay, typically a fan relay. These wires are not intended to power/ground a cooling fan directly, **DO NOT CONNECT DIRECTLY TO A COOLING FAN!** While they cannot connect directly to a cooling fan, these wires can be used to provide power and ground directly to an accessory component needed a switched power source of 20 amps or less. These wires are:

Gray/White: 16 gauge wire, printed **#901 ACC. SWITCH OUTPUT**, this wire will provide power from the **#906** wire, found on the interior of the Jeep and described on page 72, This **#901** wire will only have power when connected, directly to or switched to, the **#906**. Again, see page 72 and the accompanied schematics that follow on pages 73-78.

Black: 16 gauge wire, printed **#969 STARTER SOLENOID GROUND**, this wire will provide a ground source to the component or relay. This wire is part of the integrated ground circuit of the Painless harness. This wire can be seen in the [Ground Schematic](#) on page 13

These **#901** and **#969** wires can be used numerous ways. Connect them according to the diagrams previously shown on pages 75-80.

This now concludes the instillation of the engine harness. Make sure all zip ties and wires that have been loosely installed are cinched tight and/or bundled together. This will keep the appearance neat and will keep wires from being chaffed due to movement and vibrations.

ENGINE HARNESS NOTES:

TAIL HARNESS INSTALLATION

The last portion of the install is connecting the Tail Harness. This will require locating connector found on the interior harness, near the fuse block, labeled "TO TAIL HARNESS".

This connector will plug into the 6 pin Weather-Pac connector found on the Tail harness.

- Plug the tail harness connector found on the dash harness, into the connector labeled, "TO DASH HARNESS" on the tail harness.

If a dome light is being installed on hard top models, as discussed on page 36, connect the factory dome light pigtail to the "Dome Light" connector on the Painless Harness at this time.



Once the tail harness has been plugged in it can be routed toward the rear of the Jeep, it will route exactly as the factory harness you removed routed. This routing will depend on the model of Jeep you have:

- CJ 5 and CJ 7 models will route on the inside of the body/tub, under the driver's door opening, up and over the inner rear wheel tub, and down through the hole found in the rear. A grommet has been placed on the harness to fit this hole. The conduit "T"s will need to be removed in order to pass the harness down through the hole. Use the factory retainers along the top edge to help hold the harness up in place.

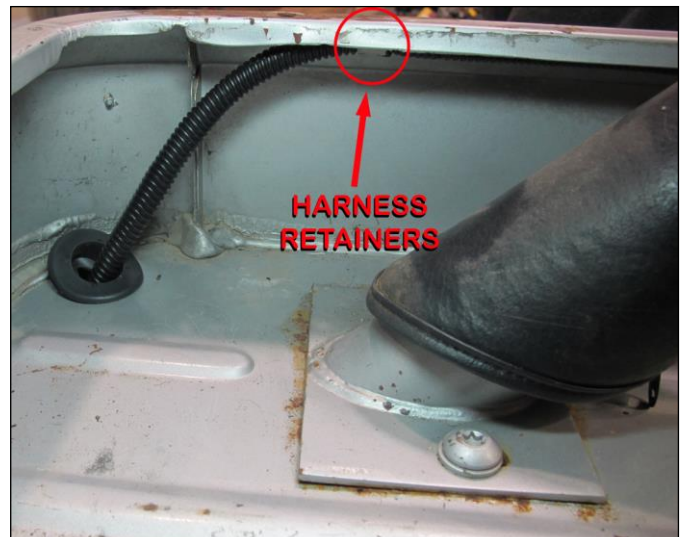
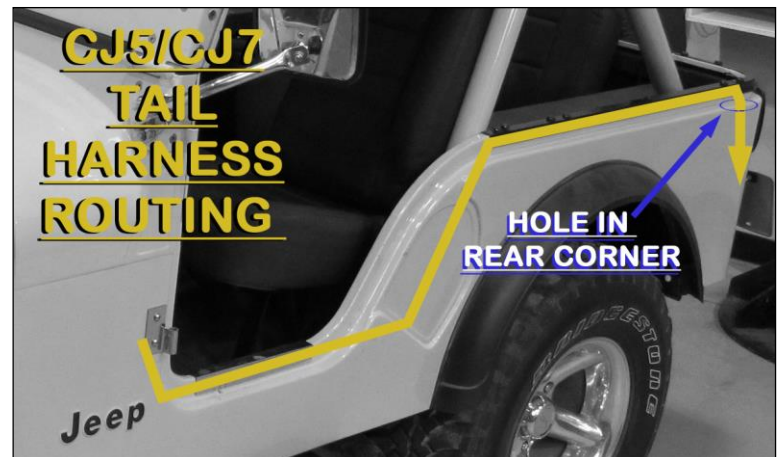

- CJ 8 models will route on the inside of the body/tub, under the driver's door opening and through a hole found behind the seat belt retractor. A grommet has been placed on the harness to fit this hole. . The conduit "T"s will need to be removed in order to pass the harness down through the hole. Once through the hole, the harness will route down the frame, to the rear.

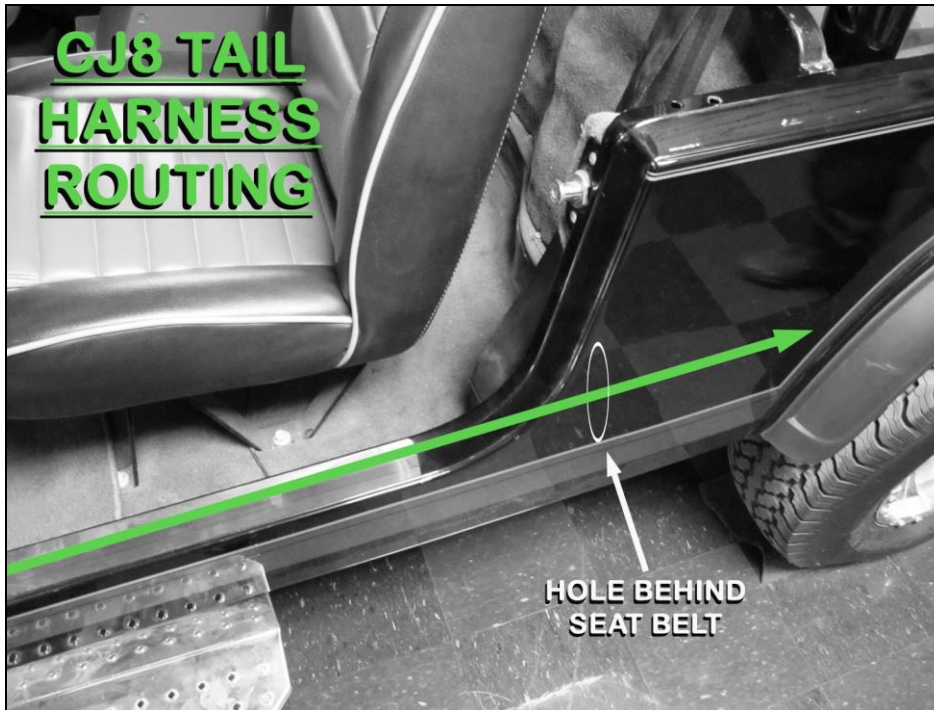

“Driver Side Park Light”

The left/driver side park light is the first connection to be made on the tail harness. Some models may not have these side park lights.

If you do not have side park lights, this connection will not be needed. Remove the bulbs from the socket; roll this unused connection up, and zip tie it to the tail harness.

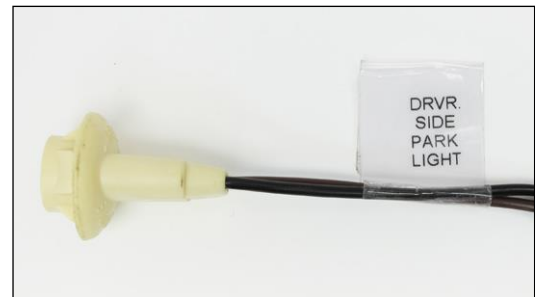

This connection will provide power and ground to the left/driver side park light. This is a two wire molded connector, these wires are:

White: 18 gauge wire, printed “#929 PARK LIGHT POWER”, this wire will provide power to the park light when the headlight switch is pulled to the “*PARK/TAIL LIGHT ON*” or the “*HEADLIGHTS ON*” positions. This white wire comes from a splice that feeds power to the tail lights and to the passenger side park light, as seen the [Tail Harness Schematic](#) on page 136. This white wire splices to a brown wire coming from the molded light socket, also seen in the [Tail Harness Schematic](#).

Black: 16 gauge wire, printed #969 PARK LIGHT GROUND, this wire will provide a ground source to the park light. This wire is part of the integrated ground circuit of the Painless harness. This wire can be seen in the [Tail Harness Schematic](#) on page 136. This wire is spliced to a black wire coming from the molded light socket. In this splice is another black wire, which provides the grounds source to the trailer connector.

- Begin by removing the park lamp lens from the side of the Jeep; this will require removing the Philip head screw on each end of the lens.

- Route the park lamp light socket through the hole in the body, as seen in the picture.

- Insert the socket into the keyed opening on the back of the lens, once inserted, turn the socket ¼ turn to lock it in place.

- Once installed, feed the excess wire back through the hole in the body and reinstall the lens to the side of the Jeep.



“Left Tail”

The wires needed for turn/brake, tail light, reverse function will be grouped together with a label reading “LEFT TAIL”. Four wires are provided for this connection, they are:

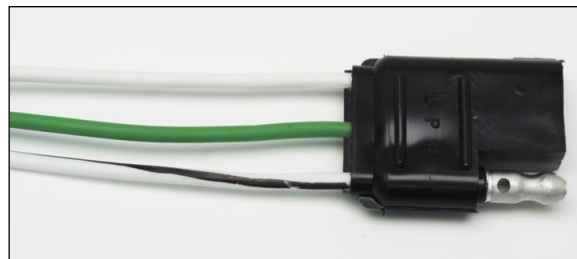

Light Green/Black- 16 gauge wire, printed **#949 LEFT TURN/BRAKE POWER**, this wire provides power to the left turn signal. This wire will have power anytime the turn signal is in the down position and the ignition switch is in the *ON/RUN* position or anytime the hazard switch is activated. This wire is also the brake light power and will also have power anytime the brake pedal is pressed. The **#949** is spliced to a molded 3 pin connector with a yellow wire; this yellow wire provides left turn/brake power to the trailer connector. The **#949** wire and this splice can be seen in the [Tail Harness Schematic](#) on page 136.

White/Black- 18 gauge wire, not printed, this wire will provide power to the reverse/back up lights. This wire receives power from the reverse switch and will have power anytime the transmission is in the *REVERSE* position. This wire is part of circuit **#956**, as seen in the splice on the [Tail Harness Schematic](#) on page 136, and is spliced to the white/black wire coming from the 3 pin molded connector.

White: 18 gauge wire, not printed, this wire will provide power to the park light when the headlight switch is pulled to the “*PARK/TAIL LIGHT ON*” or the “*HEADLIGHTS ON*” positions. This white wire comes from a splice with the **#929** circuit wires. This white wire splices to a white wire coming from the molded 3 pin connector, seen in the [Tail Harness Schematic](#).

Black: 18 gauge wire, printed **#969 TAIL LIGHT GROUND**, this wire will provide a ground source to the tail lights on Jeeps equipped with a fiberglass tub/body. This wire is part of the integrated ground circuit of the Painless harness. This wire can be seen in the [Tail Harness Schematic](#) on page 136. This black wire is open ended and not connected because the factory tail light did not require this ground as it grounds through the mounting of the tail light. This **#969** wire will only be needed if you are using a fiberglass body or aftermarket taillights that require a ground.

The molded connector found on this connection will plug directly into the connector found on factory tail lights.

- You may be able to plug this connector into the tail light without removing the tail light from the body. If you cannot see this connection from underneath, removal of the tail light will be necessary.
- Remove the screws holding the lens on. With the lens removed you will see the two screws that hold the tail light assembly to the body, remove these 2 screws.
- With the tail light assembly removed, route the molded connector found on the Painless harness through the body, and make the connection to the Tail Light; reinstall the tail light.

Jeeps with a fiberglass body, route the black **#969** wire into the tail light assembly. Using a ring terminal provided in the parts kit, connect this ground wire to one of the bolts used to mount the tail light to the body.

If you are using aftermarket tail lights that do not have a factory style molded connector, Weather-Pac connectors and terminals have been provided, seen below.

- Begin by installing the seals and terminals onto the wires coming from the tail light assemblies. Installation of these terminals was outlined on page 17 and will require the use of rollover crimpers to achieve the best possible crimp.
- Once terminals have been installed on the wires of the tail light assembly, locate the appropriate connector for these terminals, seen below, and insert the wires into the connector.
- Cut the molded connector from the Painless harness. Install the remaining terminals and seals, as instructed on page 17, and insert into the appropriate connector, see below.



Routing

To route the tail harness across to the passenger side of the vehicle, re-use the factory clips to hold the harness up tight to the body on cross member that goes across the back. If you no longer have these factory clips, new clips have been provided. These clips allow you to zip tie the harness to them.



“Ground”

A single wire, labeled “GROUND”, has been provided in the tail harness; it is:

Black: 14 gauge wire, printed **#969 TO CHASSIS GROUND**, this wire is part of the integrated ground circuit of the Painless harness. This wire can be seen in the [Tail Harness Schematic](#) on page 136.

- Using a ring terminal and a $\frac{3}{4}$ ” self tapping screw from the parts kit, connect this ground wire to one of the following locations:

Metal body/tub- Connect this wire to the body of the Jeep, to an existing bolt if a self tapping screw cannot be used. Ensure and paint/dirt/grime is removed so the ring terminal contact bare metal on the body. This will provide a clean ground source to the body. The tail lights ground through mounting to the body so this wire will ensure the body has a good ground.

Fiberglass body/tub- Connect this wire to the frame; it will help with grounding the wires provided for the tail lights. Ensure and paint/dirt/grime is removed so the ring terminal contact bare metal on the frame.

“Trailer”

This connection is an extra accessory provided with the Painless harness that was not found on a factory harness. This connector provides wires for simple trailer light connection. These wires can be seen spliced to the 4 pin trailer connector in the [Tail Harness Schematic](#) on page 136, they are:

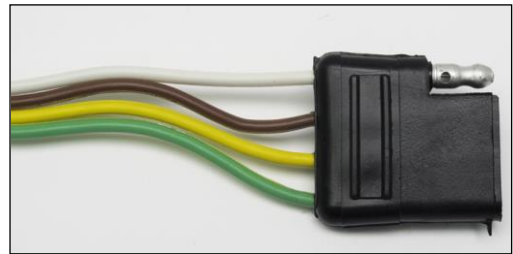

Yellow- 16 gauge wire, printed **#949 LEFT TURN/BRAKE POWER**, this wire provides power to the left turn signal. This wire will have power anytime the turn signal is in the down position and the ignition switch is in the *ON/RUN* position or anytime the hazard switch is activated. This wire is also the brake light power and will also have power anytime the brake pedal is pressed.

Green- 16 gauge wire, printed **#948 RIGHT TURN/BRAKE POWER**, this wire provides power to the left turn signal. This wire will have power anytime the turn signal is in the up position and the ignition switch is in the *ON/RUN* position or anytime the hazard switch is activated. This wire is also the brake light power and will also have power anytime the brake pedal is pressed.

Brown- 16 gauge wire, printed **#929 PARK/TAIL LIGHT POWER**, this wire will provide the tail lights and rear side marker lights power. This wire receives power from the headlight switch and will have power anytime the headlight switch is pulled into the first or second positions.

Black: 18 gauge wire, printed **#969 TAIL LIGHT GROUND**, this wire will provide a ground source to the trailer. This wire is part of the integrated ground circuit of the Painless harness. This wire is spliced to a white wire on the trailer connector.

To ensure this trailer connector will work with any small trailer you may have, a mating connector pigtail can be found in the parts kit. This mating connector is provided to install onto the trailer you plan on pulling. Weather proof splices have been provided to aid in the installation of this connector to existing wiring found on your trailer. See the [Trailer Schematic](#) on the next page.

TRAILER SCHEMATIC

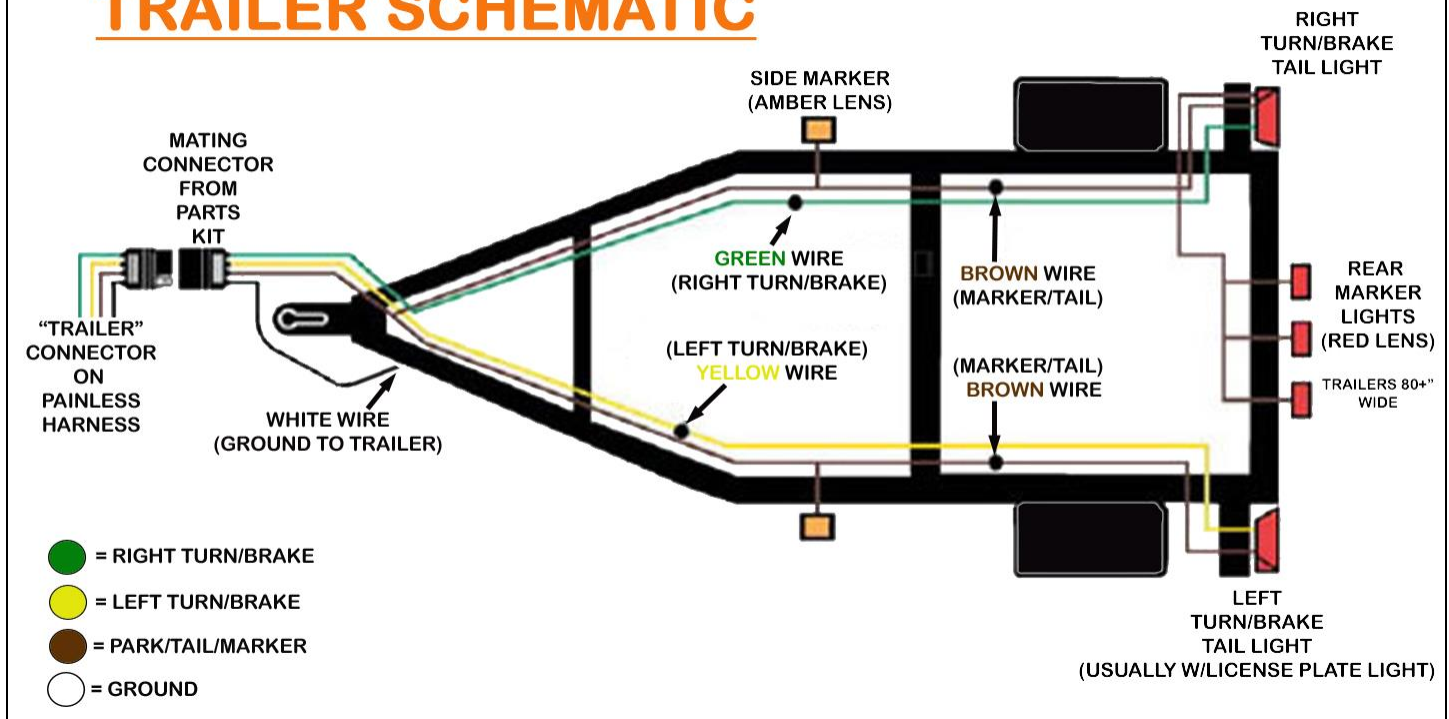

For those who flat tow their Jeep behind a RV/motor home, this trailer connector pre-installed on the tail harness can be used to provide power to the tail lights of the Jeep from your RV. Use the mating connector provided in the parts kit to either replace the trailer connector on your RV or create your own pigtail that will plug into the existing trailer connector on your RV.

Contact Painless directly at 1-800-423-9696 to purchase this pigtail.

Given how the turn signal switch is wired in the CJ Jeep, you will need to unplug your tail harness weather-pac connector to ensure your lights work correctly.

DISCONNECTING THE TAIL HARNESS

At the fuse block, locate the 6 terminal Weather-pac connector. You will need to unplug this connector and leave it disconnected anytime you are flat towing. **Make sure you reconnect the tail harness connector when the vehicle is no longer being flat towed to ensure your lights work properly.**



“Fuel Sending Unit”

The fuel sending unit connection will be a one wire connection. This wire will send a resisted ground source from the fuel level sending unit inside the fuel tank, to the fuel gage on the dash. This resistance is based off how much fuel remains in the tank, which causes the needle on the gauge to move between empty and full. This connection differs from the factory style connector. The Painless harness has a single pin weather proof connection, which is an upgrade

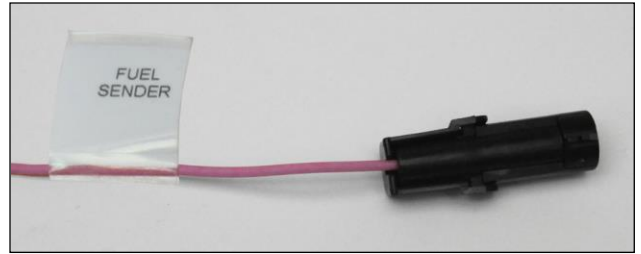

The wire provided in the Tail Harness will have a section label reading “FUEL SENDER”. This wire will have a single pin black connector, this wire is:

Pink: 18 gauge wire, printed **#939 FUEL SENDING UNIT**, this wire will provide a ground signal to the fuel gauge. It can be seen in the [Tail Harness Schematic](#) diagram on page 136.

- Locate the factory wire coming from the fuel tank sending unit, behind the rear bumper and remove the factory connector.
- Locate the 3 mating pieces to the preinstalled connector on the **#939** pink wire of the Painless chassis harness. These 3 pieces are a mating connector, a female socket terminal and a purple silicone wire seal.
- Using the instructions found on page 17, install these mating parts onto the factory wire coming from the fuel sending unit. If you do not have a wire or the existing wire has been cut or is in rough condition, use a piece of scrap wire created from a previous connection to assemble a new sending unit connection.
- Once the mating connection has been created, plug the **#939** wire into the wire coming from the sending unit.

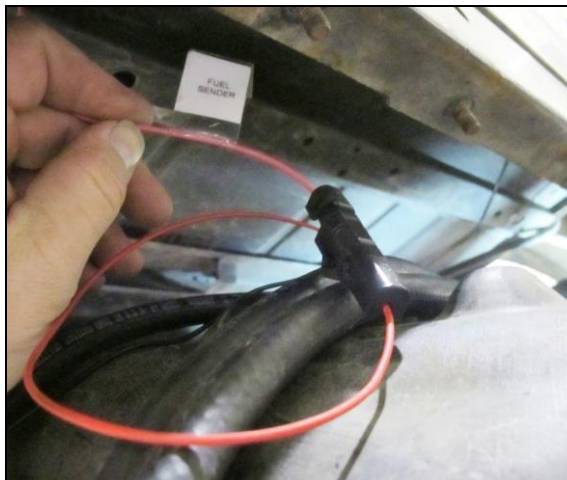

“Right Tail”

The wires needed for turn/brake/tail light function will be grouped together with a label reading “**RIGHT TAIL**”. Four wires are provided for this connection, as seen in the [Tail Harness Schematic](#) on page 136, they are:

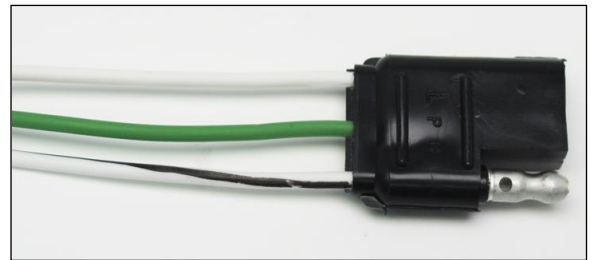

Light Green - 16 gauge wire, printed **#948 RIGHT TURN/BRAKE POWER**, this wire provides power to the right turn signal. This wire will have power anytime the turn signal is in the down position and the ignition switch is in the *ON/RUN* position or anytime the hazard switch is activated. This wire is also the brake light power and will also have power anytime the brake pedal is pressed. The **#948** is spliced to a molded 3 pin connector with a green wire; this green wire provides right turn/brake power to the trailer connector.

White/Black- 18 gauge wire, printed **#956 REVERSE LIGHT POWER**, this wire will provide power to the reverse/back up lights. This wire receives power from the reverse switch and will have power anytime the transmission is in the *REVERSE* position. This wire is spliced to the white/black wire coming from the 3 pin molded connector.

White: 18 gauge wire, printed **#929 TAIL LIGHT POWER**, this wire will provide power to the park light when the headlight switch is pulled to the “*PARK/TAIL LIGHT ON*” or the “*HEADLIGHTS ON*” positions. This white wire splices to a white wire coming from the molded 3 pin connector.

Black: 18 gauge wire, printed **#969 TAIL LIGHT GROUND**, this wire will provide a ground source to the tail lights on Jeeps equipped with a fiberglass tub/body. This wire is part of the integrated ground circuit of the Painless harness. This black wire is open ended and not connected because the factory tail light did not require this ground as it grounds through the mounting of the tail light. This **#969** wire will only be needed if you are using a fiberglass body or aftermarket taillights that require a ground.

The molded connector found on this connection will plug directly into the connector found on factory tail lights.

- You may be able to plug this connector into the tail light without removing the tail light from the body. If you cannot see this connection from underneath, removal of the tail light will be necessary.
- Remove the screws holding the lens on. With the lens removed you will see the two screws that hold the tail light assembly to the body, remove these 2 screws.

“Passenger Side Park Light”

The passenger side park light is the last connection. The park, or marker light as it is often called, is activated by a power source coming from the headlight switch. This light will illuminate any time the headlight switch is in the *PARK* or *ON* position.



The park light requires two wires to work properly. A factory style socket comes pre-installed and will have a label reading “PASS. SIDE PARK LIGHT”. The wires spliced to the brown and black wires of this molded connector are:

White: 18 gauge wire, printed “#929 PARK LIGHT POWER”, this wire will provide power to the park light when the headlight switch is pulled to the “*PARK/TAIL LIGHT ON*” or the “*HEADLIGHTS ON*” positions. This white wire comes from a splice which also provides power to the tail lights and to the passenger side park light, as shown in the [Tail Harness Schematic](#) on p. 136. This white wire splices to a brown wire coming from the molded light socket, also seen in the [Tail Harness Schematic](#).

Black: 16 gauge wire, printed #969 PARK LIGHT GROUND, this wire will provide a ground source to the park light. This wire is part of the integrated ground circuit of the Painless harness. This wire can be seen in the [Tail Harness Schematic](#) on page 136. this wire is spliced to a black wire coming from the molded light socket. In this splice is another black wire, which provides the grounds source to the trailer connector.

- Connect the “PASS. SIDE PARK LIGHT” in the same manner the driver side park light was connected on page 127 and 128.

TAIL HARNESS NOTES:

TAIL HARNESS SCHEMATIC

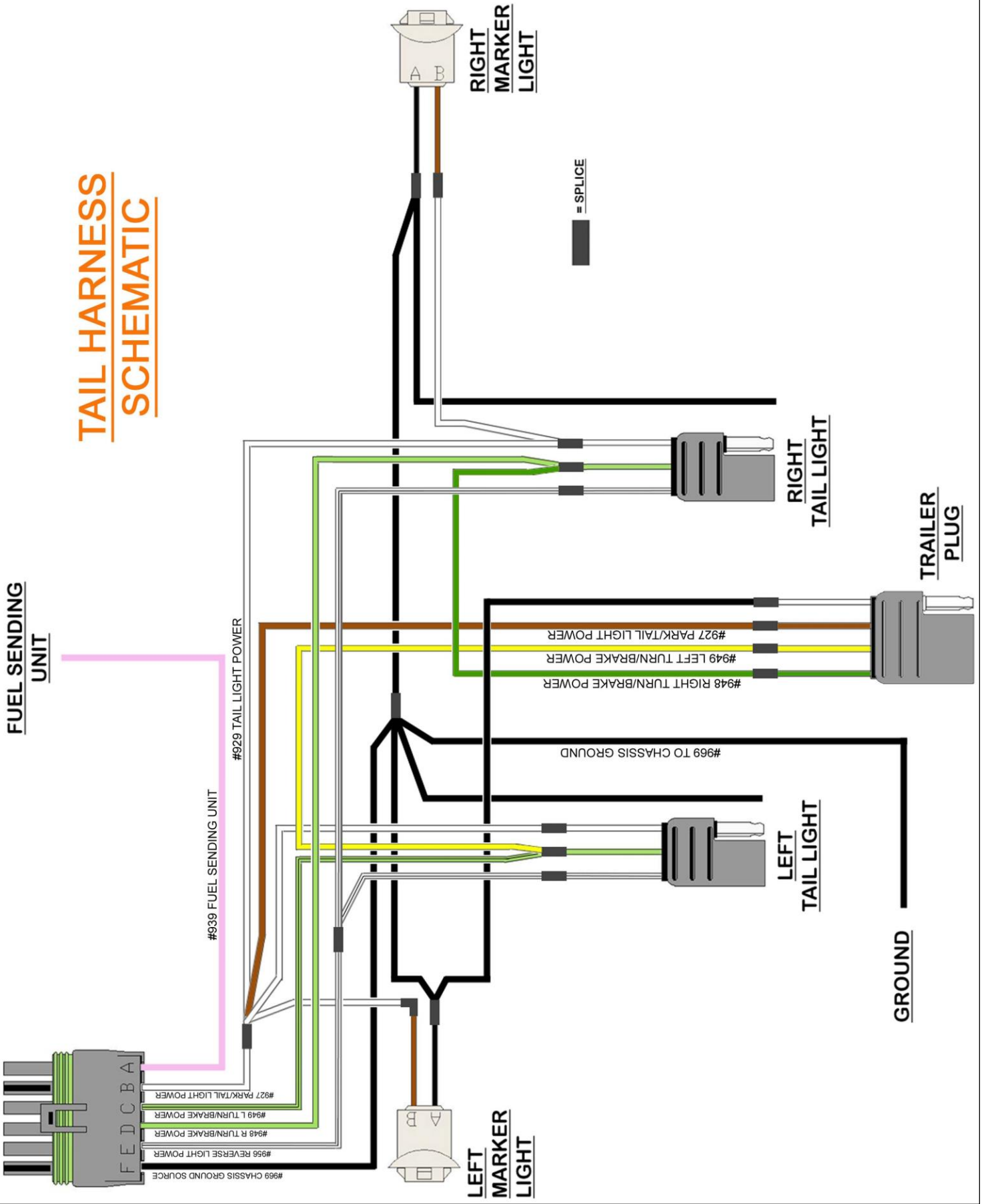

TESTING THE SYSTEM

Use a small (10 amp or less) battery charger to power up the vehicle for the first time to test the circuits. If there is a problem anywhere, the battery charger's low amperage and internal circuit breaker will provide circuit protection.

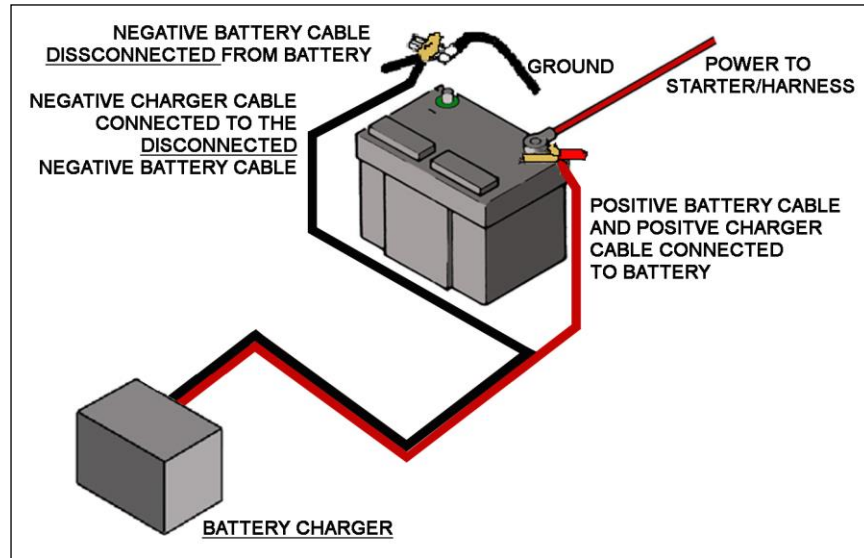

- Make sure the Negative Battery cable is connected to the frame or engine block, and make sure there is a ground between the engine and frame. **The negative battery cable should still be disconnected from the Battery.**
- Connect the Battery Positive cable to the Positive side of the Battery and also make sure this cable is connected to the B+ side of the Starter Solenoid. At this point this should also connect the red #915 from the Painless harness to the positive side of the battery, either through the starter lug or the battery lug.
- Connect the Battery Charger's NEGATIVE cable to the automobile chassis, engine block or to the disconnected Negative Battery cable. **Do NOT connect the Battery Charger's NEGATIVE cable to the Battery.**
- Connect the Battery Charger's POSITIVE cable to the automobile's positive battery terminal lug.
- INDIVIDUALLY turn on each light, ignition, wiper circuit, etc. and check for proper operation.

Note:

The charger will not provide enough amperage for each circuit to work correctly if testing more than one circuit at a time.

- After all circuits have been checked, disconnect the battery charger and attach the vehicles battery cables to the battery.
- Once testing is complete, re-install any panels, lens, or other parts that were removed during the harness installation. You are now finished installing this Painless Harness, **congratulations!**

WIRE INDEX

- The index is listed in the same order in which the manual instructed components to be connected.
- The **RED** indicates components/connection points. The connections mentioned in un-bolded **RED**, are connections found within the connection point.
- The **BLUE** descriptions indicate sections found throughout the harness.
- “Printed Information” shown in **ORANGE** is NOT actually printed on the wire. These are simply shown to provide the circuit number and the function in which that particular wire is associated. Due to short wire lengths, we cannot print some wires.
- “STARTING POINT” is simply where the opposite end of that wire is connected. Descriptions which have a “/” indicate this wire goes into an inline connector or bulkhead. For example “*Bulkhead/Low Brake Switch*” would indicate this wire goes into the bulkhead and then from the bulkhead to the low brake switch.

A dash (-) in the “STARTING POINT” box, indicates this wire is a loose wire provided with the harness. Therefore, it does not have a starting point.

Ignition Switch

<u>Print</u>	<u>Gauge</u>	<u>Color</u>	<u>Printed Information</u>	<u>Starting Point</u>
Yes	12	Red	#934 IGNITION SWITCH POWER	Fuse Block
Yes	12	Yellow	#933 SWITCHED (IGN) POWER TO FUSE BLOCK	Fuse Block
Yes	18	Black	#968 KEY ON LOW BRAKE SIGNAL	Bulkhead/Low Brake Switch
Yes	14	Red/White	#931 SWITCHED POWER TO "COIL" FUSE	Factory Tach Inline Connector/Fuse Block
Yes	12	Light Blue	#919 IGNITION SWITCH “START”	Neutral Safety Switch
Yes	12	Red	#934 IGNITION SWITCH POWER	Fuse Block
Yes	12	Brown	#932 ACCESSORY POWER	Fuse Block

Turn Signal Switch

<u>Print</u>	<u>Gauge</u>	<u>Color</u>	<u>Printed Information</u>	<u>Starting Point</u>
Yes	18	Black/White	#963 HORN RELAY GROUND ACTIVATION	Horn Relay
Yes	16	Green/Black	#926 FRONT LEFT TURN SIGNAL POWER	Bulkhead/Front L Turn Signal-Park Light Splice
Yes	18	Green/Black	#937 LEFT TURN INDICATOR POWER	Gauge Cluster
Yes	16	Green	#925 FRONT RIGHT TURN SIGNAL POWER	Bulkhead/Front R Turn Signal-Park Light Splice
Yes	18	Green	#938 RIGHT TURN INDICATOR POWER	Gauge Cluster
Yes	14	Pink	#951 HAZARD SWITCH BATTERY POWER	Fuse Block
Yes	14	Red/White	#952 TURN SIGNAL IGN. POWER	Fuse Block
Yes	16	Lt.Green/Black	#949 REAR LEFT TURN/BRAKE POWER	Tail Harness Connector/Left Tail Light
Yes	16	Light Green	#948 REAR RIGHT TURN/BRAKE POWER	Tail Harness Connector/Right Tail Light
Yes	16	Pink	#918 BRAKE SWITCH OUTPUT	Brake Switch
Yes	18	Orange	#930 GEAR INDICATOR LIGHT POWER	Gauge Backlighting Splice

Brake Switch

<u>Print</u>	<u>Gauge</u>	<u>Color</u>	<u>Printed Information</u>	<u>Starting Point</u>
Yes	16	Red/Black	#917 BRAKE SWITCH POWER	Fuse Block
Yes	16	Pink	#918 BRAKE SWITCH OUTPUT	Turn Signal Switch

Neutral Safety / Clutch Switch

<u>Print</u>	<u>Gauge</u>	<u>Color</u>	<u>Printed Information</u>	<u>Starting Point</u>
Yes	14	Purple	#919 START SIGNAL (FROM IGN.SW. TO N.SAFETY)	Ignition Switch
Yes	14	Purple/White	#919 START SIGNAL TO STARTER	Bulkhead/Starter Solenoid

*This connection has a bypass loop pre-installed for those without a column mounted NSS.

Reverse Switch

<u>Print</u>	<u>Gauge</u>	<u>Color</u>	<u>Printed Information</u>	<u>Starting Point</u>
Yes	16	Red	#958 REVERSE SWITCH POWER INPUT	Fuse Block
Yes	16	White/Black	#956 REVERSE LIGHT POWER	Tail Harness Connector/Reverse Light Splice

Dimmer Switch

<u>Print</u>	<u>Gauge</u>	<u>Color</u>	<u>Printed Information</u>	<u>Starting Point</u>
Yes	14	Red/White	#907 DIMMER SWITCH POWER	Headlight Switch
Yes	14	Gray	#909 LOW BEAM POWER	Bulkhead/Low Beam Splice
Yes	14	Gray/Red	#908 HIGH BEAM POWER	Bulkhead/High Beam Splice

Parking Brake Switch

<u>Print</u>	<u>Gauge</u>	<u>Color</u>	<u>Printed Information</u>	<u>Starting Point</u>
Yes	18	Black	#968 BRAKE WARNING SIGNAL	Gauge Cluster
Yes	18	Black/White	#969 PARKING BRAKE GROUND	Ground Splice

Dome Light

<u>Print</u>	<u>Gauge</u>	<u>Color</u>	<u>Printed Information</u>	<u>Starting Point</u>
Yes	18	Orange	#971 COURTESY/DOME LIGHT POWER	Fuse Block
Yes	18	Orange	#971 UNDER HOOD LIGHT POWER	Bulkhead/Under Hood Light
Yes	18	Black	#961 COURTESY/DOME LIGHT GROUND	Ground Splice

To Tail Harness

<u>Print</u>	<u>Gauge</u>	<u>Color</u>	<u>Printed Information</u>	<u>Starting Point</u>
Yes	18	Pink	#939 FUEL LEVEL SIGNAL	Gauge cluster
Yes	16	Lt.Green/Black	#949 REAR LEFT TURN/BRAKE POWER	Turn Switch
Yes	16	Light Green	#948 REAR RIGHT TURN/BRAKE POWER	Turn Switch
Yes	14	White	#927 TAIL LIGHT POWER	Headlight Switch
Yes	12	White/Black	#956 REVERSE LIGHT POWER	Bulkhead/Reverse Switch
Yes	12	Black	#969 TAIL HARNESS GROUND	Ground Splice

Ground

<u>Print</u>	<u>Gauge</u>	<u>Color</u>	<u>Printed Information</u>	<u>Starting Point</u>
Yes	14	Black	#969 TO CHASSIS GROUND	Ground Splice
Yes	12	Black	#969 CHASSIS GROUND SOURCE	Ground Splice

Headlight Switch

<u>Print</u>	<u>Gauge</u>	<u>Color</u>	<u>Printed Information</u>	<u>Starting Point</u>
No	12	Red	#928 HEADLIGHT SWITCH POWER	Headlight Switch Power Splice
No	12	Red	#928 HEADLIGHT SWITCH POWER	Headlight Switch Power Splice
Yes	16	White	#927 PARK LIGHT POWER	Bulkhead/Park Light Splice
Yes	14	Red/White	#907 DIMMER SWITCH POWER	Dimmer Switch
No	16	Orange	#930 PANEL LIGHT POWER	Inline Fuse @ Headlight Switch
Yes	16	Black	#961 COURTESY/DOME LIGHT GROUND	Courtesy/Dome Light Ground Splice
No	18	Orange	#930 PANEL LIGHT POWER	Inline Fuse @ Headlight Switch
Yes	18	Orange	#930 CLOCK BACKLIGHT POWER	Clock
Yes	18	Black	#969 HEADLIGHT DASH LABEL GROUND	Ground Splice
Yes	18	Black	#969 CLOCK BACKLIGHT GROUND	Clock

Headlight Switch Inline Fuse (Gauge/Panel Backlighting)

<u>Print</u>	<u>Gauge</u>	<u>Color</u>	<u>Printed Information</u>	<u>Starting Point</u>
No	18	Orange	#930 PANEL LIGHT POWER	Headlight Switch
Yes	18	Orange	#930 PANEL LIGHT POWER	Panel Light Power Splice
No	18	Orange	#930 PANEL LIGHT POWER	Headlight Switch Label Light

Clock

<u>Print</u>	<u>Gauge</u>	<u>Color</u>	<u>Printed Information</u>	<u>Starting Point</u>
Yes	18	White/Red	#965 CLOCK BATTERY POWER	Fuse Block
Yes	18	Black	#969 CLOCK GROUND	Ground Splice
Yes	18	Orange	#930 CLOCK BACKLIGHT POWER	Headlight Switch Label Light
Yes	18	Black	#969 CLOCK BACKLIGHT GROUND	Headlight Switch Label Light

Wiper Switch

<u>Print</u>	<u>Gauge</u>	<u>Color</u>	<u>Printed Information</u>	<u>Starting Point</u>
Yes	16	Red/White	#982 WIPER SWITCH POWER	Fuse Block
Yes	16	Yellow	#983 WASHER POWER	Bulkhead / Washer Pump
Yes	18	Orange	#930 WIPER LABEL POWER	Headlight Switch Label Light
Yes	18	Black	#969 WIPER LABEL GROUND	Headlight Switch Label Light

Blower Switch

<u>Print</u>	<u>Gauge</u>	<u>Color</u>	<u>Printed Information</u>	<u>Starting Point</u>
Yes	14	Red	#904 BLOWER SWITCH POWER	Fuse Block
Yes	14	Tan	#967 BLOWER MOTOR POWER	Blower Motor
Yes	14	Tan	#976 BLOWER MOTOR CONTROL/HIGH	Blower Resistor
Yes	16	Brown/White	#974 BLOWER MEDIUM	Blower Resistor
Yes	16	Brown	#975 BLOWER LOW	Blower Resistor

HVAC Dash Label Lights- these will be multiple single pin black connectors “chained” together

<u>Print</u>	<u>Gauge</u>	<u>Color</u>	<u>Printed Information</u>	<u>Starting Point</u>
No	18	Orange	#930 PANEL LIGHT POWER	Panel Light Power Splice
No	18	Black	#930 PANEL LIGHT GROUND	Ground Splice

Speedometer/Cluster- this is broken down into individual connections

3 Panel Lamp Sockets

<u>Print</u>	<u>Gauge</u>	<u>Color</u>	<u>Printed Information</u>	<u>Starting Point</u>
Yes	18	Orange	#930 PANEL LIGHT POWER	Panel Light Power Splice
No	18	Black	#930 PANEL LIGHT GROUND	Ground Splice

High Beam Lamp Socket

<u>Print</u>	<u>Gauge</u>	<u>Color</u>	<u>Printed Information</u>	<u>Starting Point</u>
Yes	18	Gray/Black	#936 HIGH BEAM INDICATOR POWER	Bulkhead/Dimmer Switch
No	18	Black	#930 HIGH BEAM INDICATOR GROUND	Ground Splice

2 Turn Signal Indicator Lamp Sockets

<u>Print</u>	<u>Gauge</u>	<u>Color</u>	<u>Printed Information</u>	<u>Starting Point</u>
Yes	18	Green/Black	#937 LEFT TURN INDICATOR POWER	Turn Signal Switch
No	18	Black	#930 PANEL LIGHT GROUND	Ground Splice
Yes	18	Green	#938 RIGHT TURN INDICATOR POWER	Turn Signal Switch
No	18	Black	#930 PANEL LIGHT GROUND	Ground Splice

Brake Warning Lamp Socket

<u>Print</u>	<u>Gauge</u>	<u>Color</u>	<u>Printed Information</u>	<u>Starting Point</u>
No	18	Red	#935 BRAKE WARNING LIGHT POWER	Gauge Power Splice
Yes	18	Black	#968 BRAKE WARNING SIGNAL	Bulkhead/Parking Brake

Four Wheel Drive Indicator Lamp Socket

<u>Print</u>	<u>Gauge</u>	<u>Color</u>	<u>Printed Information</u>	<u>Starting Point</u>
No	18	Red	#935 FOUR WHEEL DRIVE INDICATOR POWER	Gauge Power Splice
Yes	18	Orange	#984 QUADRA TRAC. LIGHT SIGNAL	Bulkhead/Four Wheel Drive Switch

Fuel & Temp Gauges

<u>Print</u>	<u>Gauge</u>	<u>Color</u>	<u>Printed Information</u>	<u>Starting Point</u>
Yes	18	Red	#935 FUEL/TEMP GAUGE POWER	Gauge Power Splice
Yes	18	Pink	#939 FUEL LEVEL SIGNAL	Tail Harness Connector/Fuel Level Sending Unit
Yes	18	Purple/White	#921 ENGINE TEMP SIGNAL	Bulkhead/Temp Sending Unit
Yes	18	Black	#969 CLUSTER GROUND	Ground Splice

Voltmeter

<u>Print</u>	<u>Gauge</u>	<u>Color</u>	<u>Printed Information</u>	<u>Starting Point</u>
Yes	18	Orange	#930 VOLTMETER LIGHT POWER	Panel Light Power Splice
Yes	18	Black	#969 VOLTMETER LIGHT GROUND	Ground Splice
Yes	18	Yellow	#935 VOLTMETER POWER	Gauge Power Splice
Yes	18	Black	#969 VOLTMETER GROUND	Ground Splice

Oil Pressure Gauge

<u>Print</u>	<u>Gauge</u>	<u>Color</u>	<u>Printed Information</u>	<u>Starting Point</u>
--------------	--------------	--------------	----------------------------	-----------------------

Yes	18	Orange	#930 OIL PRESS. GAUGE LIGHT POWER	Panel Light Power Splice
Yes	18	Black	#969 OIL PRESS. GAUGE LIGHT GROUND	Ground Splice
Yes	18	Red	#935 OIL PRESS. GAUGE POWER	Gauge Power Splice
Yes	18	Black	#969 OIL PRESS. GAUGE GROUND	Ground Splice
Yes	18	Purple	#922 OIL PRESSURE SIGNAL	Bulkhead/Oil Pressure Sending Unit

Tach

<u>Print</u>	<u>Gauge</u>	<u>Color</u>	<u>Printed Information</u>	<u>Starting Point</u>
Yes	18	Orange	#930 TACHOMETER BACKLIGHT POWER	Panel Light Power Splice
Yes	18	Red	#935 TACHOMETER POWER	Gauge Power Splice
Yes	18	Black	#969 TACHOMETER BACKLIGHT GROUND	Ground Splice
Yes	18	Purple	#923 TACHOMETER SIGNAL	Bulkhead/Coil-Ignition Section

Radio

<u>Print</u>	<u>Gauge</u>	<u>Color</u>	<u>Printed Information</u>	<u>Starting Point</u>
Yes	16	Yellow	#940 RADIO BATTERY POWER	Fuse Block
Yes	16	Red	#941 RADIO SWITCHED/IGN POWER	Fuse Block
Yes	16	Black	#969 RADIO GROUND	Ground Splice
Yes	18	Orange	#930 RADIO BACKLIGHT/DIM POWER	Panel Light Power Splice

ACC- this section contains accessory wires which can be used to power non-factory components

<u>Print</u>	<u>Gauge</u>	<u>Color</u>	<u>Printed Information</u>	<u>Starting Point</u>
Yes	16	Red	#903 CIGARETTE LIGHTER POWER	Fuse Block
Yes	16	Gray/White	#906 ACC. SWITCH/ACCESSORY IGNITION POWER	Fuse Block
Yes	16	Gray/White	#901 ACC. SWITCH OUTPUT	Bulkhead/ Acc. Relay Section
Yes	14	Brown	#902 A/C COMPRESSOR ACTIVATION	Bulkhead/ Engine Section

Heater Resistor

<u>Print</u>	<u>Gauge</u>	<u>Color</u>	<u>Printed Information</u>	<u>Starting Point</u>
Yes	14	Tan	#976 BLOWER MOTOR CONTROL/HIGH	Blower Switch
Yes	16	Brown/White	#974 BLOWER MEDIUM	Blower Switch
Yes	18	Brown	#975 BLOWER LOW	Blower Switch

Washer Pump

<u>Print</u>	<u>Gauge</u>	<u>Color</u>	<u>Printed Information</u>	<u>Starting Point</u>
Yes	16	Yellow	#983 WASHER PUMP POWER	Bulkhead/ Wiper Switch
Yes	16	Black	#969 WASHER PUMP GROUND	Ground Splice

Horn

<u>Print</u>	<u>Gauge</u>	<u>Color</u>	<u>Printed Information</u>	<u>Starting Point</u>
Yes	16	Red/Black	#924 HORN POWER	Bulkhead/ Fuse Block
Yes	16	Black	#969 HORN GROUND	Ground Splice

Driver Side Marker Light

<u>Print</u>	<u>Gauge</u>	<u>Color</u>	<u>Printed Information</u>	<u>Starting Point</u>
--------------	--------------	--------------	----------------------------	-----------------------

Yes	18	White	#927 LEFT MARKER LIGHT POWER	Park Light Power Splice
Yes	18	Green/Black	#925 LEFT TURN POWER	Left Turn Power Splice

Driver Side Headlamp

<u>Print</u>	<u>Gauge</u>	<u>Color</u>	<u>Printed Information</u>	<u>Starting Point</u>
Yes	14	Gray/Red	#908 HIGH BEAM POWER	Bulkhead/Dimmer Switch
Yes	14	Gray/Red	#908 HIGH BEAM POWER	Pass. Side Headlamp
Yes	14	Gray	#909 LOW BEAM POWER	Bulkhead/Dimmer Switch
Yes	14	Gray	#909 LOW BEAM POWER	Pass. Side Headlamp
Yes	14	Black	#969 HEADLIGHT GROUND	Ground Splice

Left Turn/Park Light

<u>Print</u>	<u>Gauge</u>	<u>Color</u>	<u>Printed Information</u>	<u>Starting Point</u>
Yes	18	White	#927 PARK LIGHT POWER	Park Light Power Splice
Yes	18	Green/Black	#925 LEFT FRONT TURN SIGNAL POWER	Left Turn Power Splice
Yes	18	Black	#969 TURN SIGNAL GROUND	Ground Splice

Right Turn/Park Light

<u>Print</u>	<u>Gauge</u>	<u>Color</u>	<u>Printed Information</u>	<u>Starting Point</u>
Yes	18	White	#927 PARK LIGHT POWER	Park Light Power Splice
Yes	18	Green	#926 RIGHT FRONT TURN SIGNAL POWER	Left Turn Power Splice
Yes	18	Black	#969 TURN SIGNAL GROUND	Ground Splice

Passenger Side Headlamp

<u>Print</u>	<u>Gauge</u>	<u>Color</u>	<u>Printed Information</u>	<u>Starting Point</u>
Yes	14	Gray/Red	#908 HIGH BEAM POWER	Driver Side Headlamp
Yes	14	Gray	#909 LOW BEAM POWER	Driver Side Headlamp
Yes	14	Black	#969 HEADLIGHT GROUND	Ground Splice

Passenger Side Marker Light

<u>Print</u>	<u>Gauge</u>	<u>Color</u>	<u>Printed Information</u>	<u>Starting Point</u>
Yes	18	White	#927 RIGHT PARK LIGHT POWER	Park Light Power Splice
Yes	18	Green/Black	#926 RIGHT TURN POWER	Left Turn Power Splice

Brake Warn. Switch

<u>Print</u>	<u>Gauge</u>	<u>Color</u>	<u>Printed Information</u>	<u>Starting Point</u>
No	18	Black	#968 BRAKE WARNING SIGNAL	Bulkhead/Gauge Cluster
No	18	Black	#968 KEY ON LOW BRAKE SIGNAL	Bulkhead/Ignition Switch

Under Hood Light

<u>Print</u>	<u>Gauge</u>	<u>Color</u>	<u>Printed Information</u>	<u>Starting Point</u>
Yes	16	Orange	#971 UNDER HOOD LIGHT POWER	Bulkhead/Dome Light

NSS/Reverse Switch

<u>Print</u>	<u>Gauge</u>	<u>Color</u>	<u>Printed Information</u>	<u>Starting Point</u>
Yes	16	Orange	#984 4WD INDICATOR ACTIVATION	Bulkhead/Gauge Cluster
Yes	16	Black	#998 NSS TO STARTER RELAY GROUND	Starter Solenoid Section
Yes	16	Red	#958 REVERSE LIGHT SWITCH POWER	Bulkhead/Fuse Block
Yes	16	White/Black	#956 POWER TO BACK UP LIGHTS	Bulkhead/Tail Harness Connector

Coil/Ignition

<u>Print</u>	<u>Gauge</u>	<u>Color</u>	<u>Printed Information</u>	<u>Starting Point</u>
Yes	16	Red/White	#920 COIL POWER (+)	Bulkhead/Fuse Block
Yes	16	Purple	#923 TACHOMETER SIGNAL/COIL (-)	Bulkhead/Tachometer

Ignition Module Bag

<u>Print</u>	<u>Gauge</u>	<u>Color</u>	<u>Printed Information</u>	<u>Starting Point</u>
Yes	18	Brown	#970 BALLAST BYPASS-STARTER RELAY/SOLENOID "I"	-
Yes	16	Red/White	IGN MODULE-IGN POWER	-
Yes	16	Green	IGN MODULE-SIGNAL	-
Yes	16	Light Blue	IGN MODULE-CRANK SIGNAL	-

Engine Section

Coolant Temp Sending Unit

<u>Print</u>	<u>Gauge</u>	<u>Color</u>	<u>Printed Information</u>	<u>Starting Point</u>
Yes	18	Purple/White	#921 ENGINE TEMP. SENDING UNIT	Bulkhead/Gauge Cluster

Oil Pressure Sending Unit

<u>Print</u>	<u>Gauge</u>	<u>Color</u>	<u>Printed Information</u>	<u>Starting Point</u>
Yes	18	Purple	#922 OIL PRESSURE SENDING UNIT	Bulkhead/Oil Pressure Gauge

Electric Choke

<u>Print</u>	<u>Gauge</u>	<u>Color</u>	<u>Printed Information</u>	<u>Starting Point</u>
Yes	18	Red	#954 ELECTRIC CHOKE POWER	Bulkhead/Fuse Block

A/C Compressor

<u>Print</u>	<u>Gauge</u>	<u>Color</u>	<u>Printed Information</u>	<u>Starting Point</u>
Yes	14	Brown	#902 A/C Compressor Activation	Bulkhead/ACC. Section

Alternator

<u>Print</u>	<u>Gauge</u>	<u>Color</u>	<u>Printed Information</u>	<u>Starting Point</u>
Yes	14	Red	#995 REGULATOR BATTERY POWER	Battery Power Splice
Yes	14	Brown	#914 ALTERNATOR EXCITER	Bulkhead/Fuse Block
Yes	6	Red	#915 ALTERNATOR OUTPUT	-

Blower Motor

<u>Print</u>	<u>Gauge</u>	<u>Color</u>	<u>Printed Information</u>	<u>Starting Point</u>
Yes	14	Tan	#967 BLOWER MOTOR POWER	Bulkhead/Blower Switch
Yes	14	Black	#969 BLOWER MOTOR GROUND	Ground Splice

Ground

<u>Print</u>	<u>Gauge</u>	<u>Color</u>	<u>Printed Information</u>	<u>Starting Point</u>
Yes	10	Black	#969 BATTERY- (GROUND FOR HARNESS)	Ground Splice

ACC Relay

<u>Print</u>	<u>Gauge</u>	<u>Color</u>	<u>Printed Information</u>	<u>Starting Point</u>
Yes	18	Gray/White	#901 RELAY ACTIVATION/ACC POWER	Bulkhead/ ACC. Section
Yes	18	Black	#969 RELAY GROUND	Ground Splice

Starter Solenoid

MIDI Fuse

<u>Print</u>	<u>Gauge</u>	<u>Color</u>	<u>Printed Information</u>	<u>Starting Point</u>
Yes	8	Red	#916 BATTERY POWER SOURCE	Battery Power Splice
Yes	6	Red	#915 ALTERNATOR OUTPUT	-

Starter Solenoid

<u>Print</u>	<u>Gauge</u>	<u>Color</u>	<u>Printed Information</u>	<u>Starting Point</u>
Yes	16	Black	#969 STARTER SOLENOID GROUND	Ground Splice
Yes	14	Light Blue	#919 START SIGNAL-"S"	Bulkhead/NSS
Yes	16	Black	#998 NSS TO STARTER RELAY GROUND	NSS/Reverse Switch

Driver Side Park Light

<u>Print</u>	<u>Gauge</u>	<u>Color</u>	<u>Printed Information</u>	<u>Starting Point</u>
Yes	18	White	#929 PARK LIGHT POWER	Park/Tail Light Power Splice
Yes	16	Black	#969 PARK LIGHT GROUND	Ground Splice
Yes	16	Black	#969 TRAILER LIGHT GROUND SOURCE	Trailer Connector

Left Tail Light

<u>Print</u>	<u>Gauge</u>	<u>Color</u>	<u>Printed Information</u>	<u>Starting Point</u>
Yes	16	Lt.Green/Black	#949 LEFT TURN/BRAKE POWER	Tail Connector/Turn Signal Switch
Yes	16	Yellow	#949 LEFT TURN/BRAKE POWER	Trailer Connector
No	16	White/Black	#956 REVERSE LIGHT POWER	Reverse Light Power Splice
No	18	White	#929 PARK LIGHT POWER	Park/Tail Light Power Splice
Yes	18	Black	#969 TAIL LIGHT GROUND	Ground Splice

Ground

<u>Print</u>	<u>Gauge</u>	<u>Color</u>	<u>Printed Information</u>	<u>Starting Point</u>
Yes	14	Black	#969 TO CHASSIS GROUND	Ground Splice

Trailer

<u>Print</u>	<u>Gauge</u>	<u>Color</u>	<u>Printed Information</u>	<u>Starting Point</u>
Yes	16	Yellow	#949 LEFT TURN/BRAKE POWER	Left Tail Light
Yes	16	Green	#948 RIGHT TURN/BRAKE POWER	Right Tail Light
Yes	18	Brown	#929 PARK LIGHT POWER	Park/Tail Light Power Splice
Yes	18	Black	#969 TAIL LIGHT GROUND	Driver Side Park Light

Fuel Level Sending Unit

<u>Print</u>	<u>Gauge</u>	<u>Color</u>	<u>Printed Information</u>	<u>Starting Point</u>
Yes	18	Pink	#939 FUEL SENDING UNIT	Tail Connector/Gauge Cluster

Right Tail Light

<u>Print</u>	<u>Gauge</u>	<u>Color</u>	<u>Printed Information</u>	<u>Starting Point</u>
Yes	16	Light Green	#948 RIGHT TURN/BRAKE POWER	Tail Connector/Turn Signal Switch
Yes	16	Green	#948 RIGHT TURN/BRAKE POWER	Trailer Connector
Yes	16	White/Black	#956 REVERSE LIGHT POWER	Reverse Light Power Splice
Yes	18	White	#929 PARK LIGHT POWER	Park/Tail Light Power Splice
No	18	White	#929 PARK LIGHT POWER	Pass. Side Park Light
Yes	18	Black	#969 TAIL LIGHT GROUND	Pass. Side Park Light

Pass. Side Park Light

<u>Print</u>	<u>Gauge</u>	<u>Color</u>	<u>Printed Information</u>	<u>Starting Point</u>
Yes	18	White	#929 PARK LIGHT POWER	Right Tail Light
Yes	16	Black	#969 PARK LIGHT GROUND	Ground Splice
Yes	16	Black	#969 TAIL LIGHT GROUND	Right Tail Light

NOTES

Painless Performance Products, LLC **Limited Warranty and Return Policy**

Chassis harnesses, fuel injection harnesses, and Trail Rocker units are covered under a lifetime warranty.

All other products manufactured and/or sold by Painless Performance are warranted to the original purchaser to be free from defects in material and workmanship under normal use. Painless Performance will repair or replace defective products without charge during the first 12 months from the purchase date. No products will be considered for warranty without a copy of the purchase receipt showing the sellers name, address, and date of purchase. You must return the product to the dealer you purchased it from to initiate warranty procedures