

PAINLESS[®]

PERFORMANCE PRODUCTS

Wire Harness Installation Instructions

Manual #90576

For Installing:

#20112 Direct Fit Camaro Harness 1970-73

#20113 Direct Fit Camaro Harness 1974-77

#20114 Direct Fit Camaro Harness 1978-81

All 26 Circuit



Painless Performance Products recommends you, the installer, read this installation manual from front to back before installing this harness and removal of the current harness installed in your vehicle. Due to the variables in modifications that can be done to these Camaros, reading this manual will give you considerable insight on the proper installation of this harness.

Painless Performance Products, LLC
2501 Ludelle St.
Fort Worth, TX 76105-1036
PHONE: 800-423-9696 FAX: 817-244-4024
EMAIL: painless@painlessperformance.com

If you have any questions concerning the installation of this harness, feel free to call Painless Performance Products' Tech Line at 1-800-423-9696. The Tech Line can be reached from 8 A.M. to 5 P.M. central time, Monday through Thursday, and 8 A.M. to 4:30 P.M. on Fridays.

We have attempted to provide you with as accurate of instructions as possible and are always concerned about corrections or improvements that can be made. If you have found any issues or omissions, or simply have comments or suggestions concerning these instructions, please write us at the above address, send us a fax at (817) 244-4024, or email us at painless@painlessperformance.com. We sincerely appreciate your business.

Painless Performance Products, LLC shall in no event be liable in contract or tort (including negligence) for special, indirect, incidental, or consequential damages, such as but not limited to, loss of property damage, or any other damages, costs or expenses which might be claimed as the result of the use or failure of the goods sold hereby, except only the cost of repair or replacement.

2nd Edition, March 2021

90576- Installation Manual

Copyright © 2012 by Perfect Performance Products, LLC

CAUTION: BEFORE THE REMOVAL OF YOUR ORIGINAL HARNESS AND/OR THE INSTALL OF YOUR NEW PAINLESS HARNESS, DISCONNECT THE POWER FROM YOUR VEHICLE BY REMOVING THE NEGATIVE OR POSITIVE BATTERY CABLE FROM THE BATTERY. THE BATTERY IS NOT TO BE CONNECTED UNTIL THE PAINLESS HARNESS HAS BEEN INSTALLED AND TESTED.

- A full color copy of these instructions can be found online at <http://www.painlessperformance.com/InfoSearch/manuals.php>
- If your vehicle has an existing harness, you will want to retain it for the possible re-use of various pigtails & connector housings particular to your application. During the removal process, avoid making any unnecessary cuts. Included in this kit is a sheet of pre-printed labels, to assist in identifying connections as the existing harness is removed from the vehicle. Place these labels on your factory harness accordingly as you disconnect it from the vehicle.

This harness does NOT contain any A/C wiring or power window/power lock wires. It does include the power wires for the A/C switch, PW & PL options. Do not remove the power window/lock or A/C harness from the vehicle if you have these options and plan on retaining these features.

Painless part # **30715** is a factory style power window/power lock harness for these vehicles if a replacement harness for this option is needed.

This harness also does not include the wiring for the TCS relay for turbo 400 transmissions, rear window defrost, power antenna, cruise control found on 1979-1981 Camaros or the computer controlled carburetor system found on 1980 to 1982 Camaros.

- It's a good idea to document how the original harness is routed as this Painless harness follows most of the same routing.
- If you do not have an existing harness, the package of terminals included with the harness will enable you to make most of the connections needed that aren't already provided on the harness.
- Only printed wires will have a 900-series number. These 900-series numbers are used to identify various wires and circuits in the wiring diagrams that are a part of these instructions.
- **In the event that there are unused or unconnected wires, the ends of all wires labeled in this instruction manual as "POWER" or wires printed with "B+" in the description, will need to have the ends terminated with an insulated terminal or taped. Doing so will prevent the wires shorting and causing harness failure or fire.**

TABLE OF CONTENTS

<u>PAGE #</u>	<u>SECTION</u>
8	Introduction
9	Contents of the Painless Kit
10	Small Parts
10	Tools Needed
11	Pre-Installation Guidelines
12	Installing Factory Terminals
13	Grounds
16	Fuse Block
16	Horn Relay
16	Flashers
17	Accessory Ports
18	Relays and Switches
19	Fuse Block Mounting
20	Engine Harness
21	Washer Pump Routing
21	Bulkhead
22	Bulkhead Pin out
23	Bulkhead Mounting
24	Light Section
24	Low Brake Switch
25	Washer Pump
26	Left Side Marker
27	Left Headlight
28	Left Ground
28	Left Turn/Park
32	Horn(s)
33	Right Turn/Park, Right Headlight, Right Side Marker
33	Right Ground
34	Wiper Motor
35	Washer Pump
36	Under Hood Light
37	Engine/Ignition Section
38	Coil/Ignition
38	Coil Power
41	Ignition Bypass
41	Tachometer
42	Engine Sending Units/Switches
42	Coolant temp
42	Oil Pressure
43	Electric Choke
44	Start/Charge Section
44	Alternator
53	MIDI Fuse
54	Starter
56	Interior Harness
57	Dimmer Switch
58	Emergency Brake Switch
59	Key Buzzer

60	Seatbelt Buzzer-Relay
61	Power Window & Power Lock
63	Driver Side Door Jamb Switch
65	Brake Switch
67	Blower Switch Power
69	Blower Switch Panel Light
70	Interior Ground
71	Driver Side Courtesy Light
72	Neutral Safety Switch/Clutch Switch
73	Reverse Switch
74	Ignition Switch
77	Turn Signal Switch
80	Radio
81	Cigarette Lighter/Power Port
82	Clock
83	Instrument Cluster
83	Alternator Exciter Connectors
86	Pre-Terminated Wires
88	Factory Cluster with Indicator Lights
89	Factory Cluster with Gauges
90	Aftermarket Gauges
95	Voltmeter
95	Headlight Switch
98	Wiper Switch
98	1970-1971 Switches
99	1972-1974 Switches
100	1975-1978 Switches
101	1979-1981 Switches
102	Wiper Switch Panel Light
104	Aftermarket Gauges
105	Gear Indicator Light
106	Passenger Side Courtesy Light
107	Seatbelt Light
108	Glove Box Switch
109	Glove Box Light
109	Passenger Side Door Jamb Switch
110	TAIL SECTION of the MAIN HARNESS
112	Seat Belt Ground
112	Dome Light
113	Fuel Pump
114	Tail Harness Connectors
116	1970-1973 TAIL HARNESS INSTALLATION
116	Driver Side Park Light
119	Left Turn/Brake/Tail Light
120	Reverse Light
121	Fuel Sending Unit
121	Ground
122	License Plate Light
124	Right Turn/Brake/Tail Light
125	Reverse Light
126	Passenger Side Park Light

127	1974-1977 TAIL HARNESS INSTALLATION
129	Driver Side Park Light
130	Left Turn/Brake/Tail Light
130	Reverse Light
131	Routing
131	License Plate Light
132	Ground
132	Fuel Sending Unit
133	Reverse Light
134	Right Turn/Brake/Tail Light
135	Passenger Side Park Light
136	1978-1981 TAIL HARNESS INSTALLATION
139	Driver Side Park Light
139	Left Brake/Tail Light
140	Left Turn Signal
141	Reverse Light
142	License Plate Light
142	Ground
143	Fuel Sending Unit
144	Reverse Light
144	Right Turn Signal
145	Right Brake/Tail Light
145	Passenger Side Park Light
147	TESTING the SYSTEM
148	WIRE INDEX

Schematics and Drawings

<u>PAGE #</u>	<u>SECTION</u>
15	GROUND SCHEMATIC
17	FUSE BLOCK ACCESSORY PORTS
18	RELAY 12 VOLT ACTIVATION
19	RELAY GROUND ACTIVATION
23	ENGINE HARNESS ROUTING
31	FRONT EXTERIOR LIGHTING SCHEMATIC
39	BALLAST RESISTOR CONNECTION
40	NO BALLAST RESISTOR CONNECTION
40	MSD CONNECTION
54	CHARGE/BATTERY SCHEMATIC
55	STARTER SCHEMATIC
69	HEATER ONLY SCHEMATIC
71	COURTESY/DOME LIGHT SCHEMATIC
76	IGNITION SWITCH SCHEMATIC
78	TURN SIGNAL SWITCH SCHEMATIC
79	TURN SIGNAL SWITCH CONNECTOR PIN OUT
82	ACCESSORY SCHEMATIC
85	CHARGE INDICATOR LIGHT
88	FACTORY CLUSTER w/INDICATOR LIGHTS PIN OUT
89	FACTORY CLUSTER w/GAUGES PIN OUT
91	GAUGE HARNESS 30301/30302 PIN OUT
91	POWERING AFTERMARKET GAUGES (SPLICING)
92	POWERING AFTERMARKET GAUGES (CHAINING/JUMPERING)
92	GROUNDING AFTERMARKET GAUGES (SPLICING)
93	GROUNDING AFTERMARKET GAUGES (CHAINING/JUMPERING)
93	POWERING AFTERMARKET GAUGE LIGHTING (SPLICING)
94	POWERING AFTERMARKET GAUGE LIGHTING (CHAINING/JUMPERING)
94	AFTERMARKET GAUGE SENDER/SIGNAL WIRES
95	GAUGE POWER SCHEMATIC
97	HEADLIGHT SWITCH SCHEMATIC
103	WIPER SWITCH SCHEMATIC
105	AFTERMARKET GAUGE CONNECTOR PIN OUT
117	1970-1973 TAIL HARNESS GROUNDS
117	1970-1973 TAIL HARNESS POWER
128	1974-1977 TAIL HARNESS GROUNDS
128	1974-1977 TAIL HARNESS POWER
137	1978-1981 TAIL HARNESS GROUNDS
137	1978-1981 TAIL HARNESS POWER

INTRODUCTION

Thank you for your purchase of a Painless Performance product. These instructions along with the Painless harness have been designed to allow you, the installer, the cleanest and easiest install possible.

Do not let the length of these instruction manuals intimidate you. Much of the information contained in these manuals is just helpful information about each wire, where the wire comes from, where it goes, why a component needs it, etc. You will find that the actual install portions of this manual are pretty straight forward and easy to follow.

- The install portions are noted with a round bullet note, as seen here.

Individual components and sections are labeled with printed tags for easy identification. The colors used in this harness are the most common colors GM used during the production of these Camaros. In some instances, a wire color may not match your factory color. This is because the colors were not exactly uniform throughout this time frame. In most cases it was a simple stripe color change. These colors, along with the schematic diagrams found throughout this manual, will help you identify the different circuits during installation and later on if additions to the overall system are necessary.

The complete wiring systems, as well as the instruction manuals, have been designed with 3 harnesses incorporated into it:

ENGINE HARNESS, INTERIOR HARNESS, TAIL HARNESS

With this harness covering so many years, and so many variables in modifications that can be done to these Camaros, there may be wires and pre-installed connectors that are not needed in your specific application. Harness routing may also differ according to your year model or use of aftermarket components such as gauges, shifters, steering column, etc.

During the course of reading this manual you will notice wire colors with a slash, as an example Black/White. This indicates a wire with a stripe. The first color is the main color of the wire and the color after the slash is the stripe color. In the case of the example, Black/White indicates a black wire with a white stripe.

CONTENTS OF THE PAINLESS WIRE HARNESS KIT

Refer to the **Contents Figure** (on the next page) to take inventory. See that you have everything you're intended to have in this kit. If you find that anything is missing or damaged, please contact the dealer where you obtained the kit or Painless Performance at (800) 423-9696.

The Painless Wire Harness Kit should contain the following:

- Main Wire Harness, with the fuse block and interior bulkhead
- Engine wire harness, with the firewall bulkhead
- Tail section harness, with the appropriate year range label for your particular vehicle.
- Charge indicator pigtail: in a small bag labeled "CHARGE INDICATOR"
- 2 front turn signal pigtails (20113 & 20114 kits only)
- Parts Kit: loose piece terminals, grommets, etc.
- Alternator bag kit
- Installation manual



CONTENT FIGURE- All of the parts in the Painless kit

SMALL PARTS

Included with the Painless harness is a parts kit containing miscellaneous insulated terminals, fuses, screws, and nuts. The terminals that have a semi-transparent insulation are heat shrinkable to provide a weatherproof connection. These terminals include disconnect, ring, and splice terminals and have been provided for engine bay connections.

One small bag kit contains all of the components for an inline fuse installation and alternator connections. This fuse is to isolate the battery from the alternator and Painless harness. These parts include the base with cover, fuse, mounting screws and ring terminals. Page 45 will go into detail about this bag.

The other small bag contains a single wire pigtail and is labeled "Charge Indicator". This pigtail will be applied to the install on those with 1973+ gauge clusters with indicator lights instead of actual gauges.

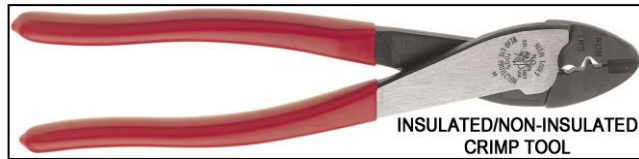

TOOLS NEEDED

In addition to your regular hand tools, you will need, at least, the following tools:

➤ **Wire Crimping and Stripping Tools:**

This style of hand crimper can be purchased from just about any local auto parts store, home improvement store or can also be purchased online. You will need this style of crimper to crimp the heat shrinkable and non-heat shrinkable insulated terminals included in the small parts kit.

Another style of crimpers are "Jaw Crimpers" or "Roll Over Crimpers". These crimpers will crimp factory style, un-insulated terminals. These types of terminals are provided in the kit for connections to an HEI distributor, engine compartment bulkhead and factory style alternator. If none can be found locally, these crimpers can be found using Painless part # [70900](#).



A good set of wire strippers are required to strip wire properly. This style of wire stripper is ideal for this harness install because of its ability to properly strip wire gauges 10 to 20. These are available from just about any local auto part store, electrical supply shop, home improvement store or can be purchased online.

➤ **Volt/Ohm Meter:**

A Volt/Ohm meter is always a good tool to have on hand when installing any type of electrical components into any vehicle. Most basic units provide the two functions required to diagnose electrical issues seen during a harness install. These two functions are the ability to read DC Voltage and electrical continuity or Ohms. They can be purchased from any home improvement store, local hardware store and electrical supply shop and online.



➤ **Electric Drill & Bits:**

A drill and bits are needed in order to use the screws provided with the kit for the MIDI fuse holder and the fuse block mounting.

➤ **Heat Gun:**

Very useful to shrink the heat-shrinkable terminals found in the parts kit.

➤ **Small (10 amp or less) Battery Charger**

See **TESTING THE SYSTEM** located on page 147.

➤ **Factory Wire Schematic**

This isn't absolutely necessary; however, having one handy is good practice with any electrical job. Old Clymer manuals and Haynes manuals, which can be found at most auto parts stores and online, usually contain these schematics.



PRE-INSTALLATION GUIDELINES

The installation of your wire harness mainly consists of two parts:

- The physical routing and securing of the wire harness, wires, and groups.
- The proper connection of the individual circuits.

These two major tasks are not separate steps, but are integrated together. That is, you will route some wires and make some connections, route more wires and make more connections. This Painless harness follows much of the same routing the factory harness did. Harness routing also may differ according to your year model or use of aftermarket components such as gauges, shifters, steering column, engine driven accessory brackets, etc. Harness routing also depends a great deal as the extent you want to secure and conceal the harness. This aspect will be more prominent in the ENGINE SECTION wiring, where some of the harness is visible.

The best pre-installation practice is to become familiar with the harness by locating each of the harness sections. A good way to do this is by laying out the wire harness on the floor and identifying each of the section labels found on the harnesses you read through the manuals. The wire index in the back of the Tail Harness Manual will help to quickly identify each wire in these sections.

During the install, wires should be bundled into groups. Use nylon ties, split loom, or tape. Exposed wires of the engine compartment and wires running to the rear of the vehicles may need some sort of wiring loom or covering. *Painless offers Power Braid Kit part #70923 to fill this need. This kit is specifically designed to fit the Camaro harness and includes everything you will need to add extra protection to your new harness.*



PowerBraid Kit

INSTALLING FACTORY STYLE TERMINALS

In the parts kit you will see different non-insulated male and female terminals. These terminals are for connections that do not come pre-installed on the Painless harness. In most cases this is to allow the installer the freedom to route the wires however they best see fit and cut a wire to length.

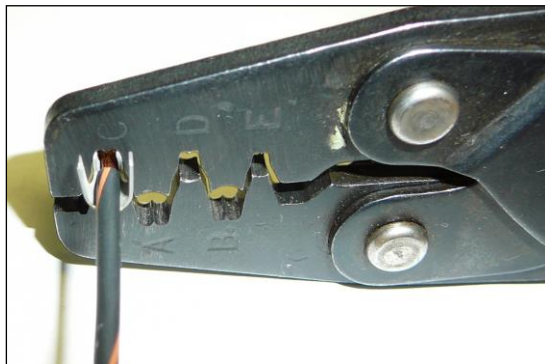
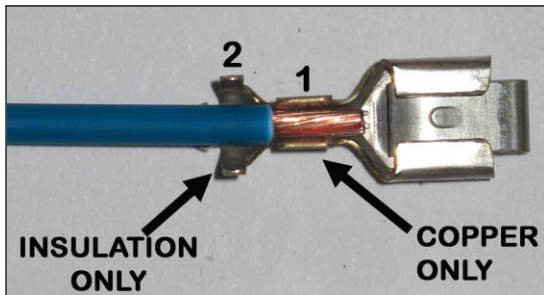

- Strip about ¼” of insulation off of the wire.
- Insert the wire into the terminal. There are 2 terminal straps on the terminal. For instructional purposes, we will label them 1 and 2. Strap 1 crimps the exposed copper strands of the wire, while strap 2 crimps the wire insulation. Make sure your strip length is long enough to ensure only copper strands are crimped by Strap 1, but make sure it is short enough that only insulation is crimped by Strap 2. The photo to the left best demonstrates this.
- Using the appropriate jaw on the crimpers, crimp Strap 1. The appropriate jaw depends on the wire gauge as well as the terminal stiffness. If you are unsure which jaw to use, you can always start with the biggest and work your way down until you get a tight crimp.
- With Strap 1 crimped you can move onto crimping the insulation strap, Strap 2. Place Strap 2 into the appropriate jaw of

the crimpers. This jaw will be larger than the one used to crimp the first strap. Crimp down on Strap 2 making sure the strap folds downward into the wire, and not overlapping itself, refer to the drawing below. Overlapping could cause problems with the terminal fitting into the factory connector.

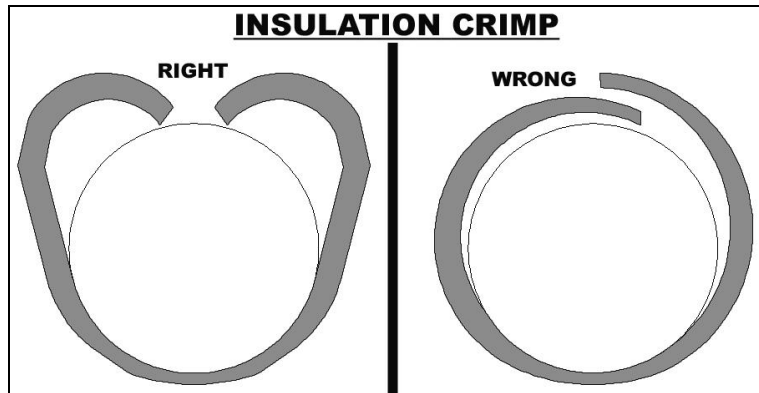

Grounds

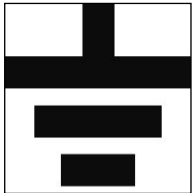

Throughout this instruction manual and when looking at the Painless harness you will see the word GROUND, maybe you've seen the ground symbol on wire diagrams? What exactly is a ground and why do you need it?



You've probably noticed the large cable coming from the negative side of your battery going down to the sub frame or to the engine. This cable allows voltage to get back to the battery through the metal of the sub frame and all the other metal pieces bolted to the frame. **It is also important to have ground cables going from the sub frame to the engine and from the sub frame to the body.** Painless offers part # 40140, seen in the photo, to supply proper grounds back to the battery.

A ground is simply the common path voltage takes back to the battery. A ground, or chassis ground as it is often called, is any bare metal surface found on the vehicle which is in turn connected back to the front frame through mounting points and ground straps. They are needed in order for the voltage current to have some place to go.

There are two ways components are grounded in the Camaro: through mounting and through wire connection. Some grounds on the earlier model Camaros are grounded through the mounting of the metal housings in which the bulbs are installed, like the front turn signals. Components such as the headlights, tail lights, radio, and gauge cluster all get their grounds through wires from the chassis harness, which are attached to ground sources which you will find in the harness.

To help avoid grounding problems, all the ground wires in the Painless harness are connected together through a series of splices. All of these splices connect to large 10 gauge wires in the engine compartment and in the trunk to allow a ground connection directly to the battery depending on the battery location. Ground wires are also present where the factory had them installed: 2 on the front core support for each headlamp and turn signals, 1 on the interior behind the Gauge cluster, and 1 in the trunk. The [Ground Schematic](#) on page 15 has been provided to show you exactly which wires of the Painless harness are part of the integrated ground circuit.

On light housings that ground through the mounting and for the harness ground wire connection points make sure that all mounting points are clean by removing all dirt, corrosion, or paint. This is especially important for cars that have just been painted as paint build up will cause grounding issues. 80 grit or courser sandpaper should be all that's needed to properly clean grounding points.

Why are clean grounds important?

As an example we will use a park light bulb, like the front park lights on the second gen Camaro which have turn signal and park light functions. Follow the red line from right to left in the diagrams on the next page. This red line indicates the path electrical current takes when everything is properly grounded and as represented in the second diagram, when the ground is bad; notice which bulbs illuminate when good and bad grounds are present.

In our park light example with a good ground source, current travels from the headlight switch to the park light bulb. Since the bulb is properly grounded, current passes cleanly through the bulb causing it to illuminate and the current exits the bulb through the ground source back to the battery. The ground allows everything to work properly without any issues.

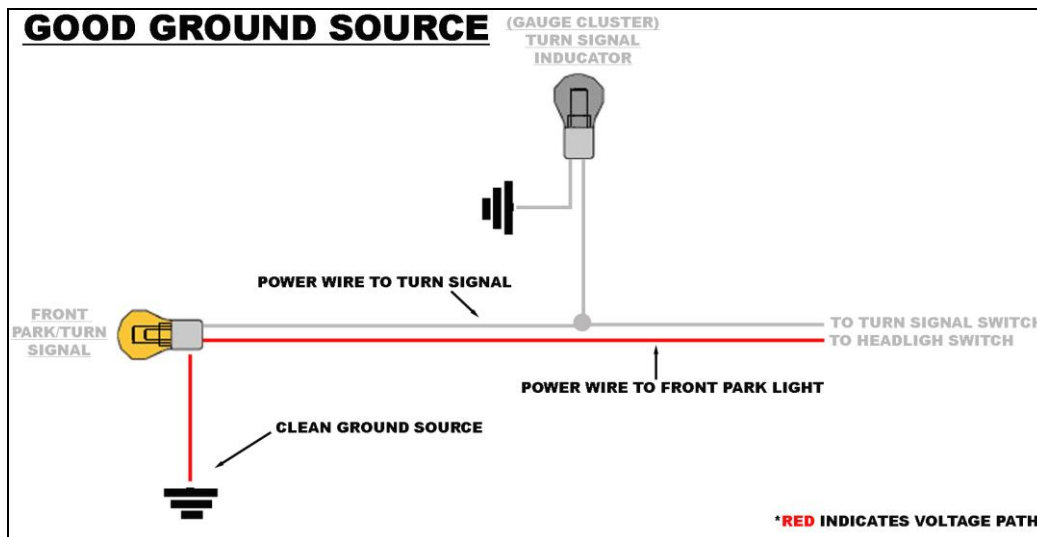

When a ground isn't connected or is contaminated with dirt, corrosion, or paint, the voltage will find the easiest path to ground, which is represented in the diagram below.

Current travels from the headlight switch to the park light bulb, but wait; there is no ground at the bulb. Since the ground it would normally use is not there, the current will find another way to get to ground and back to the battery. When this happens, things that should not have power receive power coming from the park light bulb. Since the turn signal wire also goes to the bulb, the current will travel out of the bulb through the turn signal wire. Notice in the diagram that a bad ground at the front park light can cause issues on the interior of the vehicle at the turn signal indicator on the dash. In this case, the turn signal indicator light is illuminated when it shouldn't be. Also, since this one power source which was only supposed to power 1 bulb is not powering 2 bulbs, both bulbs may be dimmer than they would have been if everything was grounded properly. This is one of the problems with diagnosing a bad ground; they can cause issues throughout the entire vehicle.

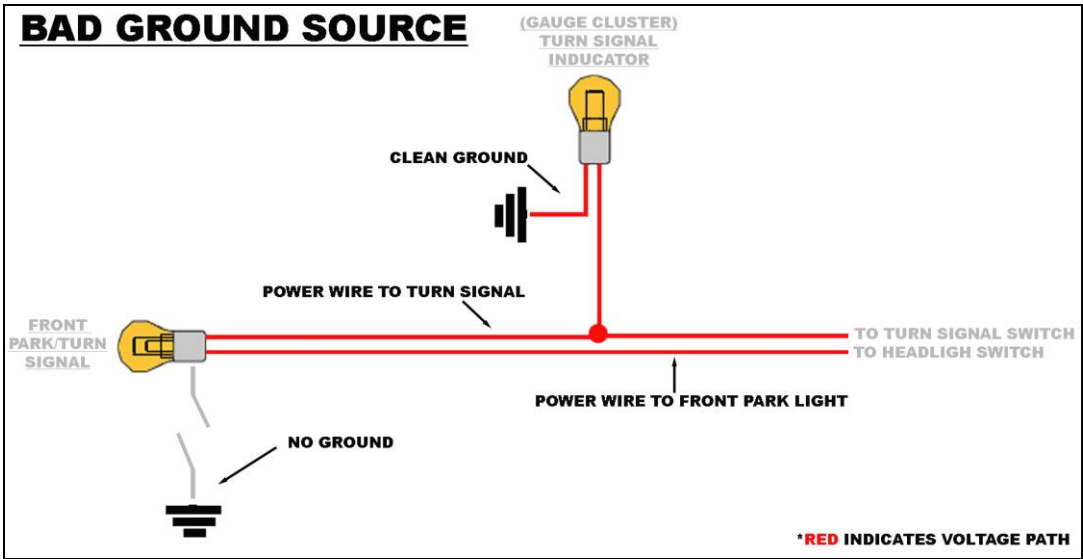

Notes

GROUND SCHEMATIC

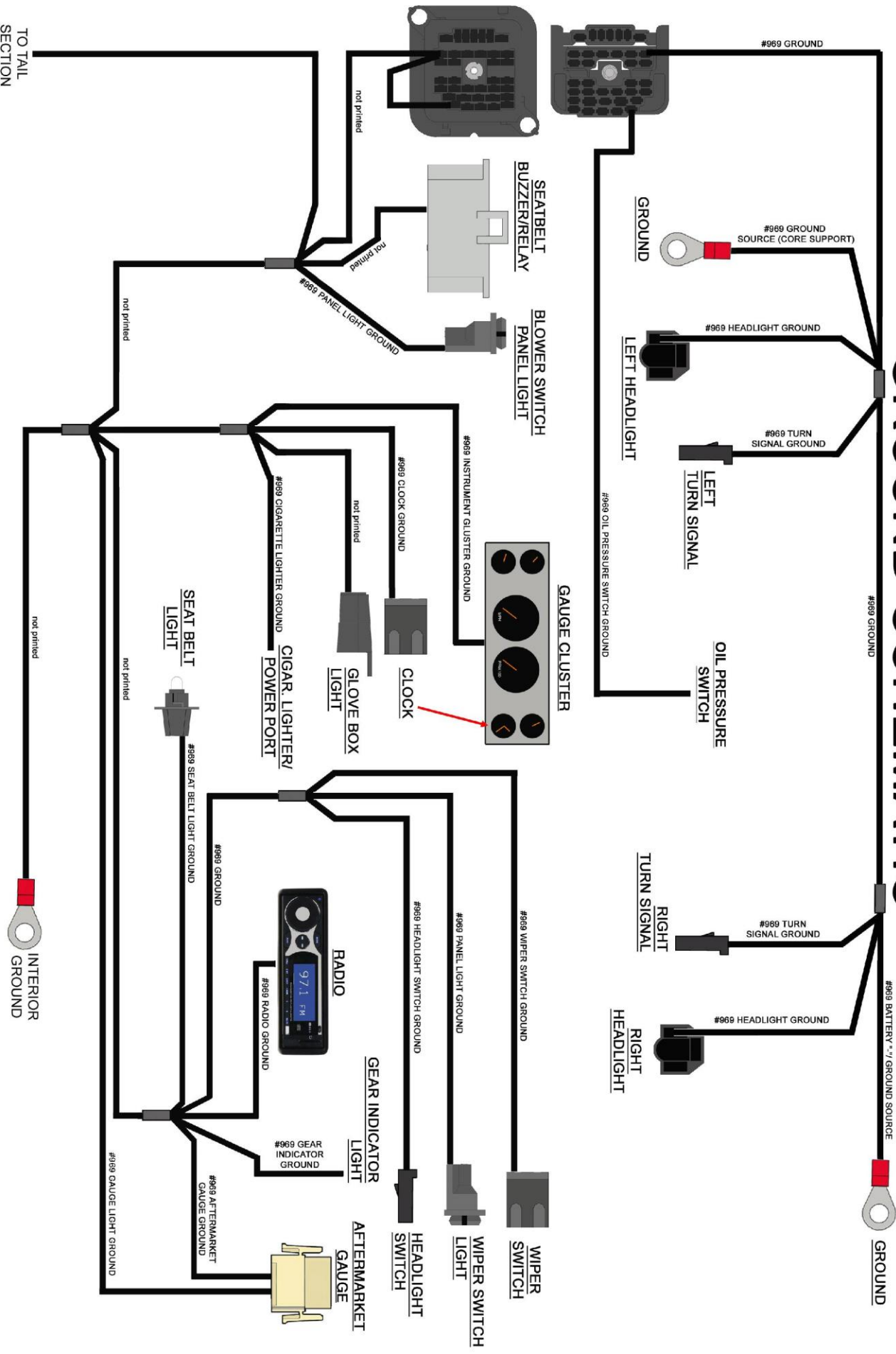

FUSE BLOCK

The Painless harness contains an 18 circuit GM style fuse block with the same mounting pattern as the factory installed fuse block. One big difference you will notice, outside of the additional circuits, is the larger fuse block uses modern ATC blade style fuses. This fuse block allows the convenience of having both flashers (turn signal and hazard), as well as the horn relay, to be mounted in one location.

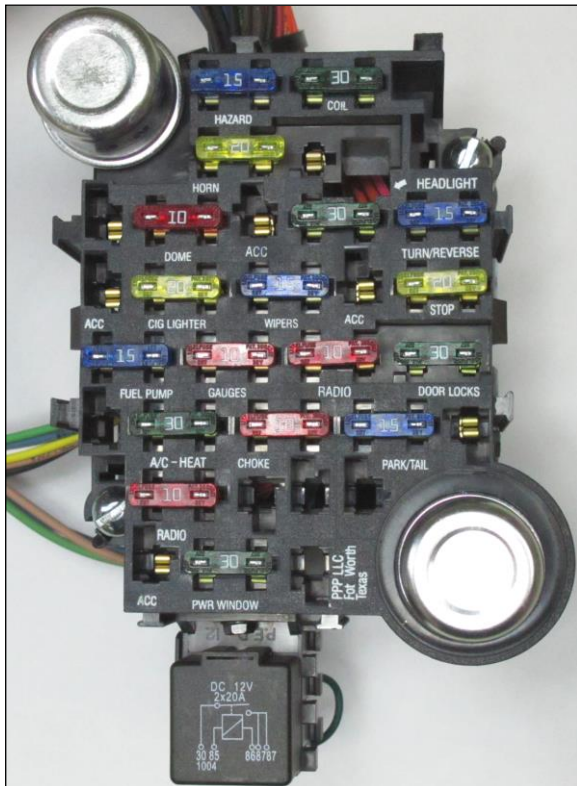

Horn Relay

On the fuse block you will find a horn relay, which replaces the factory core support mounted horn relay. The fuse block mounted horn relay uses a standard 30 amp SPST relay. Replacement relays for the horn relay can be found at any auto parts store or by ordering [Painless part number #80131](#).

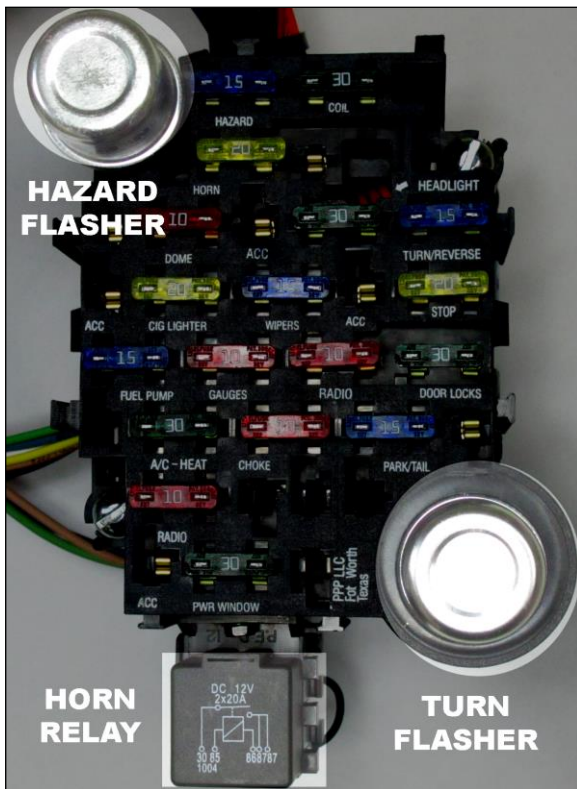

Also, because of the new horn relay, the key buzzer found on the early 2nd gen Camaro horn relay is now gone and is not supported by the Painless harness. However, the interior key reminder buzzer found on the later model Camaros is supported. Those with the earlier models can purchase key buzzer, GM part, # 6262663 online to fill this obsolete function of the core support mounted buzzer.

Flashers

The two flashers simply switch power off and on going to the turn signal switch and hazard switch. The flasher found in the top left corner is the hazard flasher. The flasher on the bottom right corner is the turn flasher.

How a flasher functions is simple. Power is switched off and on according to heat built in the resistance wire inside the flasher. As soon as power is drawn through the flasher, as when the turn signal or hazard switch is activated, the resistance wire heats up and makes contact with the output side of the flasher. This contact passes power through the flasher, into the switch and to the turn signal lamp(s). Once this contact has been made, the resistance wire is no longer resisting any voltage, so it begins to cool; this cooling causes the flasher to lose contact.

This loss of contact means that there is no longer any voltage going to the switch, causing the turn signal light to turn off. Once contact is lost, the resistance wire begins heating up and the entire process starts over again until the turn signal switch or hazard switch is disengaged.

Some L.E.D. turn signals do not draw enough voltage to activate a typical thermal flasher. If you are using L.E.D. turn signals, and your turn signals do not work properly and you are certain everything is connected properly, a no load flasher will be required; Painless [part number #80230](#).



Accessory Ports

You will notice single ports on the fuse block, many of these are labeled "ACC". These ports will give you access to battery power and switched power to extra circuits you may need now or in the future. You will need to test the ports or refer to the diagram, at right, in order to tell which ports have battery power and which have switched power.

Terminals and connectors have been provided in the parts kit to allow you to tap into these extra sources, seen below. **The ports are all un-fused power sources and must have an inline fuse, no larger than 15 amps, installed before being routed to a component needing power.** Anything needing more than 15 amps will need to have a relay installed. See relay wiring and activation on the next page for details.

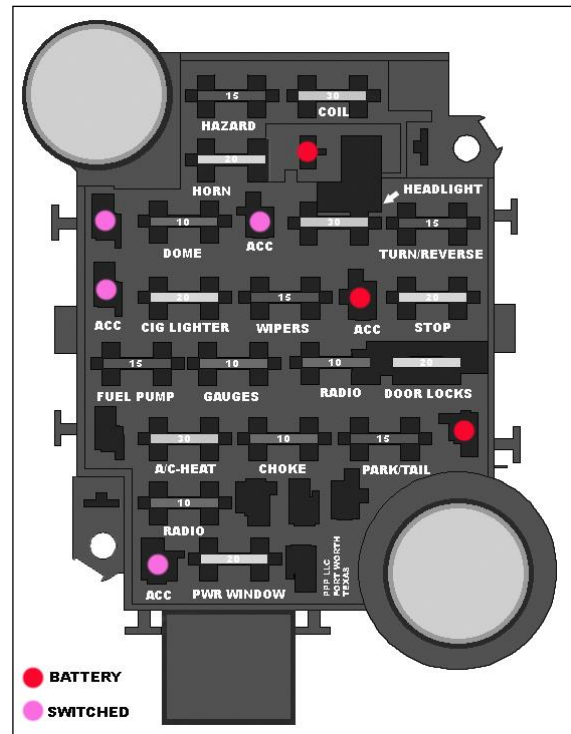

Relays and Switches

All ACCESSORY PORTS on the fuse block and the ports on the engine side of the bulkhead connector can support up to 15 amps. Components requiring more amperage will need to be connected to a relay. An ACCESSORY PORT can be used as a 12 volt activation source or 12 volt source for ground activation in these circumstances. *Take a look at [Painless part #'s 30107 & 30108](#) to fill your relay needs.*

A 12 volt activated relay is constantly grounded and will send power out of the output side of the relay to the component being powered when 12 volts is applied to the relay, as the name implies. The 12 volt source can be wired directly to the relay or interrupted by a switch, as shown in the *12 VOLT SOURCE ACTIVATION* drawing.

Wiring directly to the relay, as indicated by the dashed line, would be used in the case of wiring a Fuel Pump relay, water pump relay, or any other high amperage component you would want to run continuously while the key is in the on position. In these cases, make certain the 12 volt wire you are using is a Switched 12 volt wire and not a battery constant hot.

The 12 volt activation wire can also be wired to a switch to offer the user OFF/ON capabilities. These are the situations a battery constant power source would be used. This would allow a component to be turned OFF or ON without the key in the ON position. However, unless a lighted switch is being used, a ground activated relay may work better to avoid running power through the switch.

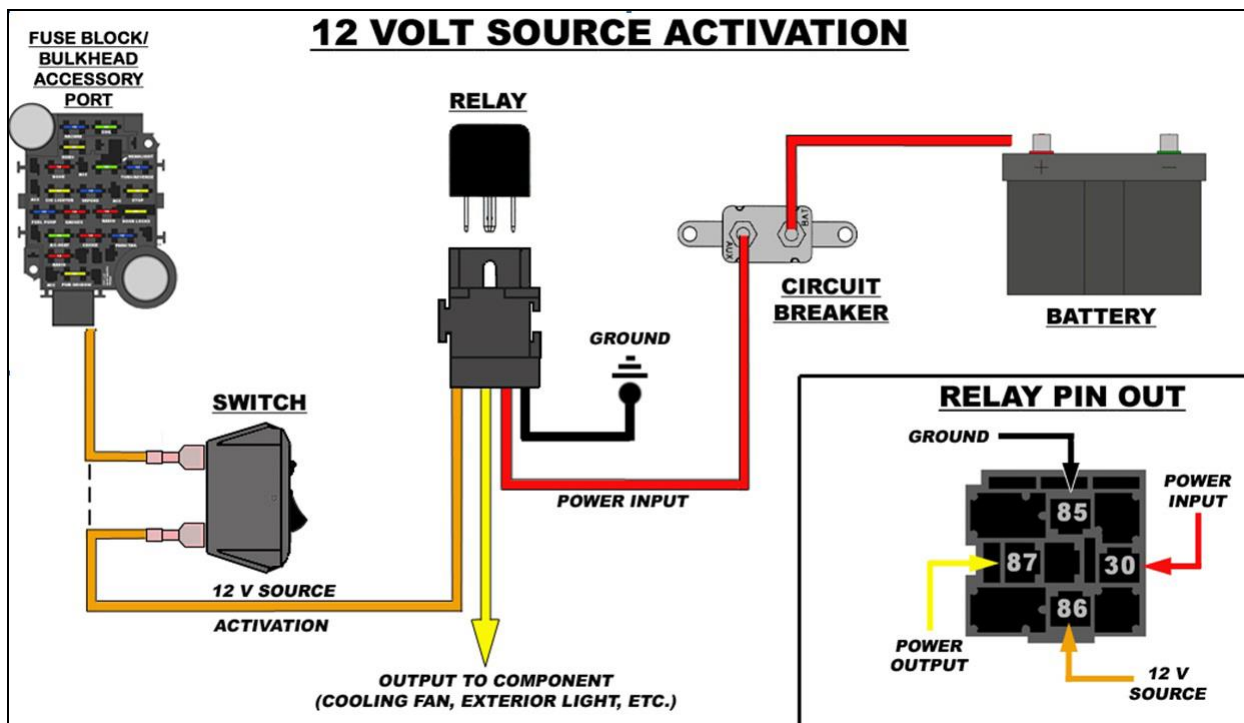

A ground activated relay is just the opposite of the 12 volt activated relay, 12 volts (battery constant or switched) is supplied uninterrupted and the ground wire is switched. The Horn Relay pre-wired in the Painless harness is a Ground Activated Relay. Another example of this method is a thermostat operated fan relay. In this case however, a thermostatic switch would replace the switch in the drawing below. Like mentioned before, ground activation method is best used when a component is operated by an unlit switch from the interior of the vehicle.

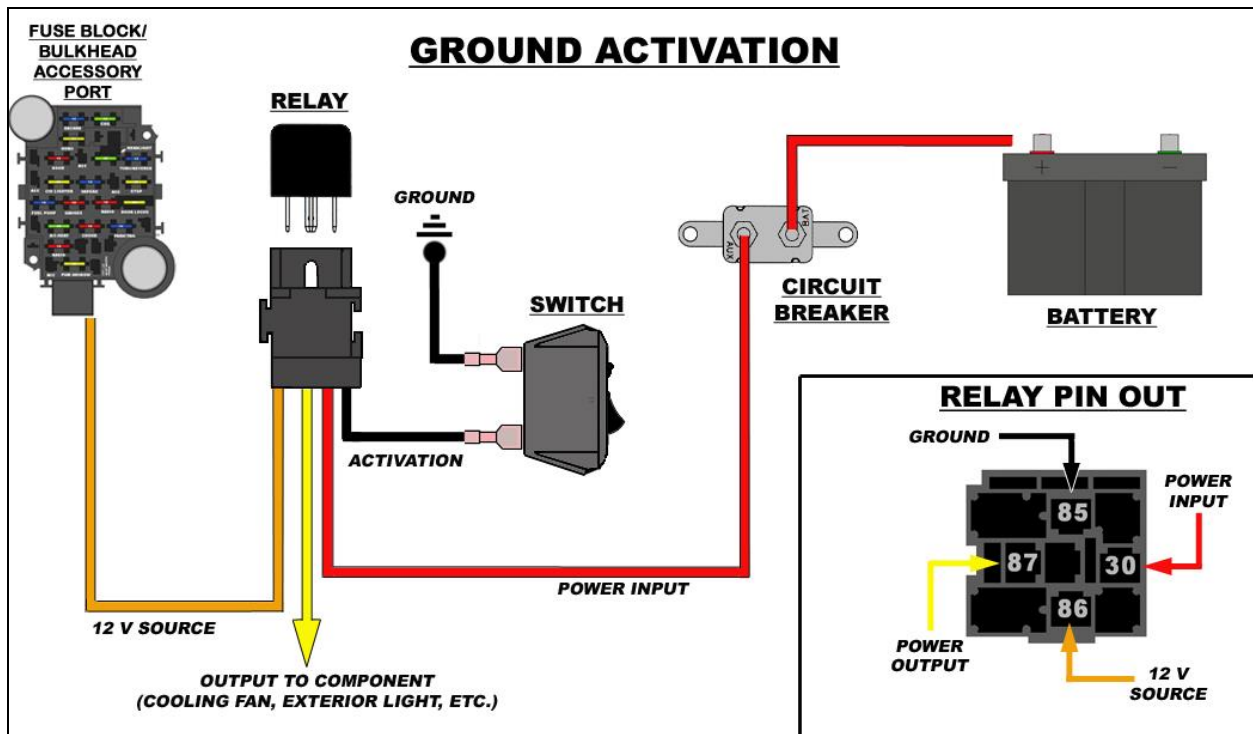

In the event that a toggle/rocker switch is being used without a relay, make sure the amperage of the component you are powering does not exceed the capabilities of the switch. Switch failure will occur.

Fuse Block Mounting

To begin mounting the fuse block, you will need to enlarge the 2 factory mounting holes; these holes can be found next to the upper right and lower left of bulkhead opening. A 1/4" or 5/16" bit and an electric drill will be required for this modification.

- Using the drill bit, enlarge both firewall mounting holes. This will allow the 1/4" fuse block mounting bolts supplied with the Painless harness to pass through the firewall.

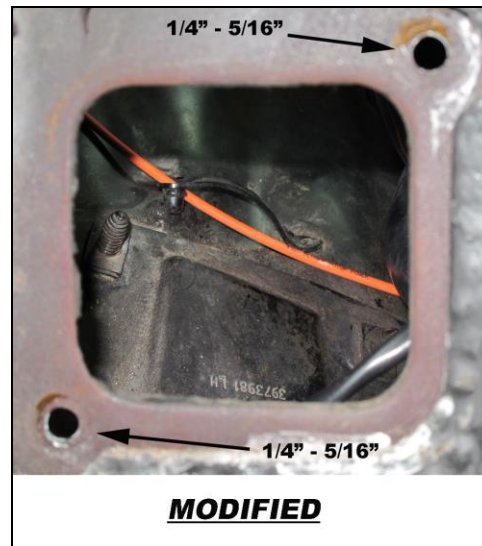
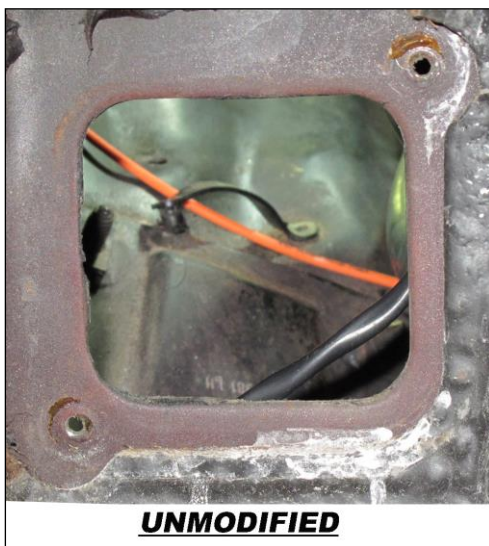

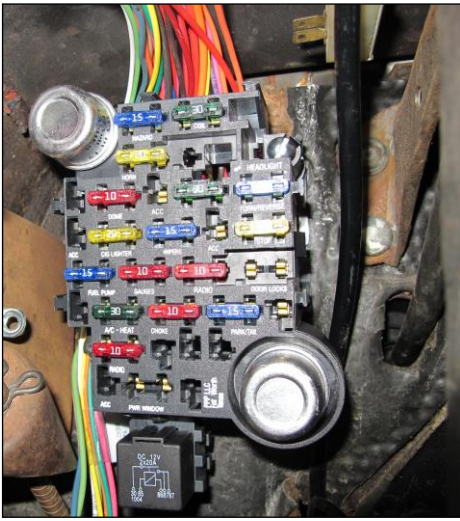

With the holes enlarged, the fuse block can now be mounted.

- Remove the 2 nuts and flat washers pre-installed on the fuse block.
- Before being mounted, ensure you have the tail section and the dimmer switch connection coming out of the left side of the fuse block.
- Install the fuse block onto the firewall by inserting the bolts through the fuse block and then through the enlarged firewall mounting holes.

This next step will require a helper.

- On the engine side of the firewall, install the flat washers and nuts previously removed from the fuse block, this will require the use of a 7/16 socket as a wrench may be difficult to operate in the confined space. A helper with a flat head screw driver will be needed on the inside of the vehicle to keep the bolts from turning while the mounting nuts are tightened.

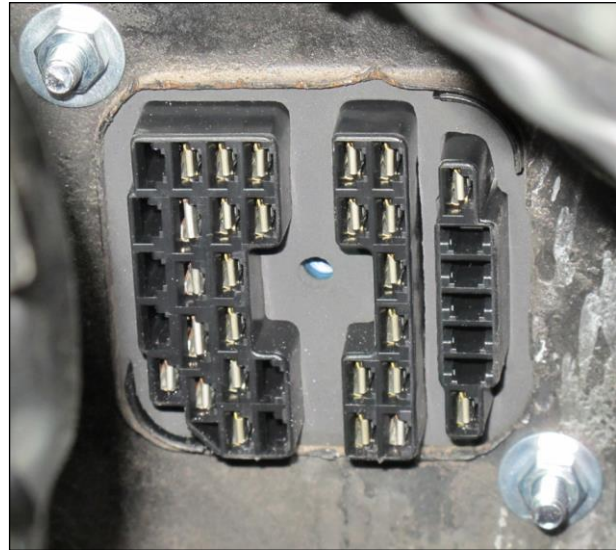

ENGINE HARNESS

The engine harness is broken down into three groups of wires leaving the bulkhead connector:

- Light Section- contains wiring for the low brake switch, headlights, marker lights, park/turn signals, horns, washer pump, and grounds.
- Wiper Motor- contains wiring for the wiper motor
- Engine Section- contains 2 sub groups of wiring
 - Engine/Ignition- contains wiring for oil pressure, temp sensor, electric choke, coil (power and tach. signal)
 - Start/Charge- contains alternator, MIDI fuse, and starter connections

Washer Pump Re-Routing

Take notice to where the windshield washer pump is located in your vehicle. Some vehicles have a firewall/wiper motor mounted pump; others have a pump located on the washer fluid reservoir.

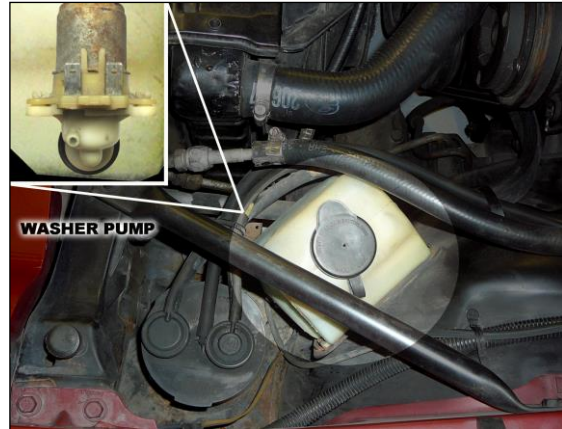
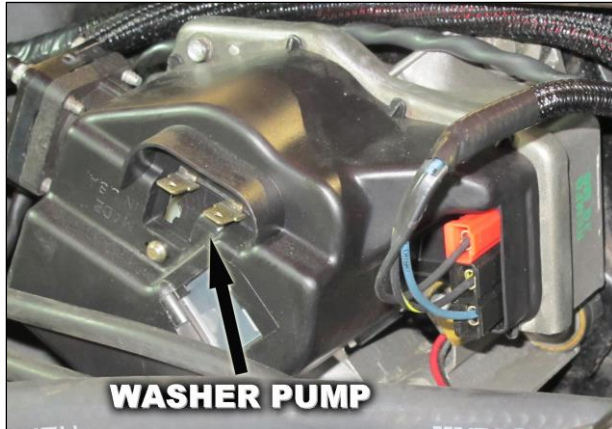

The Painless harness, as it comes out of the box, is set up for a reservoir mounted pump. This is because it requires the most length of the 2 pump mounting locations. This connection will be labeled "Washer Pump" and will have 2 wires: a Blue wire and a Yellow /Black wire.

If you have a wiper motor mounted washer pump, this connection will need to be removed from the Light Section and grouped with the "Wiper Motor" wires. Modification to these wires will be handled on page 35.

Engine Bulkhead

The photo below shows the interior bulkhead coming through the firewall in the engine compartment. The engine harness will plug directly into this connector. However before doing so, there is an optional feature built into this connector that can be beneficial to your install.

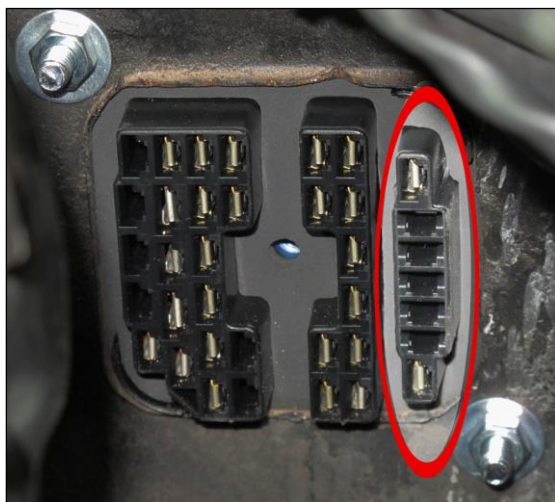

In the engine compartment, looking at the right hand side of the interior bulkhead, and highlighted/circled in the photo at left, you will see that there is a 7 pin portion with two pins having a terminal pre-installed. Both of these pins will have power anytime the key is in the "ON" / "RUN" position. This will make wiring up any under hood accessories requiring a switched power source easier than having to source power from the inside of the vehicle.

The power on these pins comes directly from the Ignition Switch. These pins are all unused power sources and must have an inline fuse, no larger than 15 amps, installed before being routed to a component needing power. Anything needing more than 15 amps will need to have a relay installed. See relay wiring and activation on page 16 for details.



Looking at the mating connector to the bulkhead on the engine harness, you will notice that the wires needed for the accessory switched power pins are not included. This is so there would not be a lot of un-fused wires running out in the engine compartment; most installs will not require this many additional switched power sources. There is no harm in leaving these ports open if you do not require any addition switched power sources.

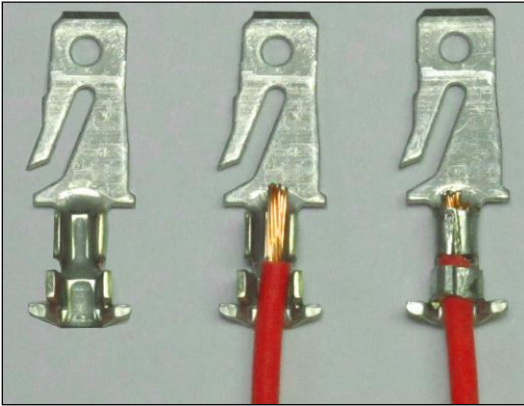

In order to utilize these switched power sources, you must add wires to the engine harness bulkhead. Terminals have been provided in the parts kit for these connections, seen in the photo to the left. These terminals will accept 18-14 gauge wire, using a 1/4" strip length, and will need to be installed with jaw style crimpers as shown on page 8.

If any wires were added to the bulkhead connector for the extra switched power sources, group each wire with one of the 3 sections of wires coming from the bulkhead according to where the fuse will be installed. For instance, if you are mounting an inline fuse on the driver

side inner fender to power an accessory, the wire that would connect to this fuse will route with the **Light Section**.

Bulkhead Pin Out

Before connection of the bulkhead takes place, look over the pin out to see if there are any wires you will not be using. Things like one or both of the wires for delay wipers (most delay motors will only use the Green wire), electric choke, under hood light, gauge wires if you are using aftermarket mechanical gauges, and tachometer wire are all things some people may not be using. These unused wires can be removed to clean up the install and to keep unused wires from being taped or wrapped up in the harness. Read through this entire manual before any wires are removed, **Do not remove any of the other wires.**

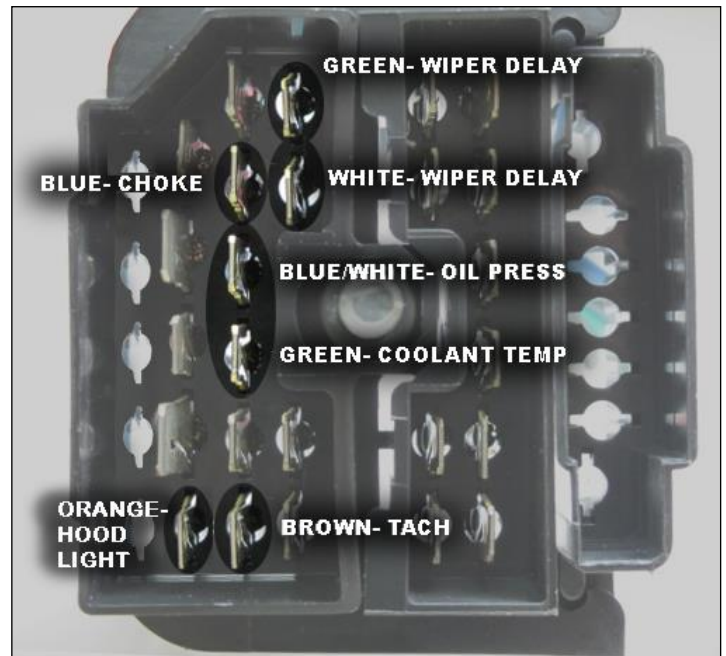

Removal of these wires is simple and will require the use of a pair of pliers or a flat head screw driver.

- Squeeze the smaller side of the terminal in towards the center of the terminal. This will allow the terminal to be pulled free of the bulkhead.

Be careful not to damage any of the surrounding terminals

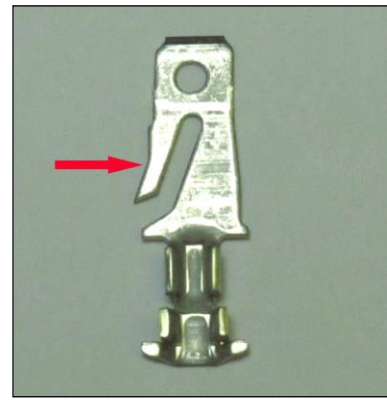

Engine Bulkhead Mounting

With all extra wires added to the engine bulkhead connector, if they were needed, it can now be installed onto the firewall connector.

- Push the engine bulkhead onto the firewall connector as far as you can, it will not go all the way on because of the bolt.
- Using a phillips head screw driver or a ratchet with a phillips bit, tighten the mounting thru bolt on the engine bulkhead to the fire wall connector.



DO NOT FORCE OR OVER TIGHTEN!

Engine Harness Routing and Installation

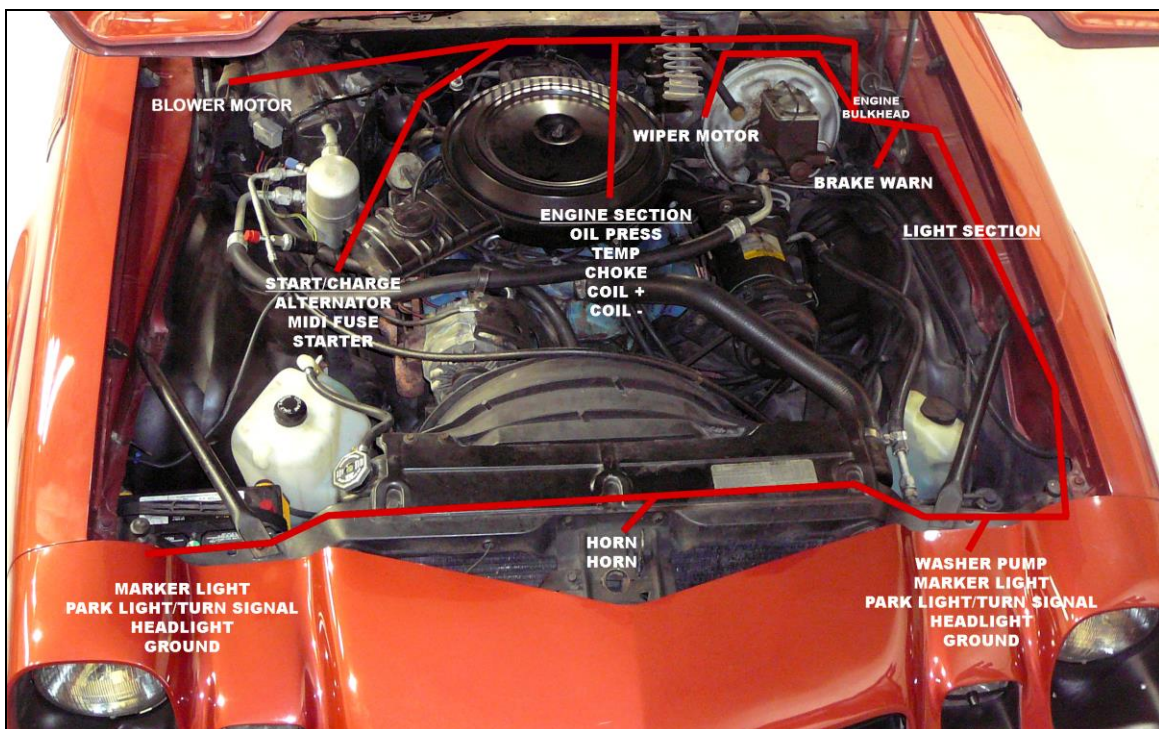

The photo on the previous page shows the routing of the Engine harness; the factory harness followed this same routing. It will be up to you, the installer, to position all wires away from sharp edges, hood hinges, moving parts and exhaust heat.



“Umbrella” style zip ties have been provided for you to attach the Painless harness to the inner fender and the core support in the same fashion the factory did. These zip ties fit into the ¼” holes left behind by the factory plastic retainer loops.

Remember, as the zip ties are installed and the harness is routed, wrap the tie around the harness and LOOSELY tie the harness to the fender/core support. Make sure you leave enough room to pull and push the harness as you make your connections. Once all connections are made, tighten the zip ties.

You will also notice in the “ROUTING” photo showing the connections found in the engine compartment, this harness does not include the wiring for the Turbo 400 automatic transmission TCS relay or solenoid. This has been omitted due to a lack of customer usage.

Light Section

The Light Section has a little extra length added to allow the installer to route the harness over the inner wheel well, behind the driver side fender. Doing so will make for a cleaner install as there will not be wires routed down the fender out in the open as the factory did.

- Route the Light Section towards the front of the vehicle. If this section is routed behind the driver side fender, make sure the “Low Brake Switch” wire remains on the engine compartment side.

“Low Brake Switch”

The Low Brake Switch is a normally open switch that will close and send a ground signal to the brake light indicator light on the dash. This is done when the bias valve inside the proportioning valve has shifted forward or back because of line pressure differences. This is usually caused by broken/leaking brake line, faulty caliper or wheel cylinder. Notice, this is a pressure switch not a fluid level switch.

This switch is only necessary if you want the brake warning light in the dash to indicate low brake fluid pressure. If you have aftermarket gauges without a brake warning light, then this connection can be skipped.

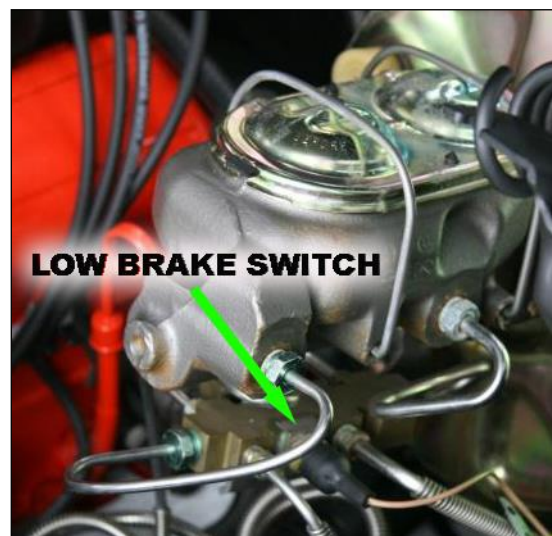

The Low Brake Switch is located on the proportioning valve near the brake master cylinder. If you have an aftermarket proportioning valve, you may not have one of these switches. Aftermarket valves that have a two pin switch on them are normally for brake light activation, this type of switch will not work as an activation source for the indicator light on the dash.

The Low Brake Switch is a one wire connection. This will be a wire with a label reading "LOW BRAKE SWITCH". This wire is:

Tan: 18 gauge wire, printed with **#968 LOW BRAKE SWITCH**, this wire supplies a ground signal to the low brake light on the dash. This wire goes into the bulkhead connector and is spliced together with the wire going to the emergency brake switch on the interior of the vehicle; see the [Ignition Switch Schematic](#) on page 75.

- Connection to the Low brake switch can be done 2 different ways.
 - You can use an insulated bullet or socket terminal found in the parts kit. Some switches require a male terminal, while others require a socket terminal.
 - You can remove the connector from your factory harness and splice it to the wire of the Painless kit.

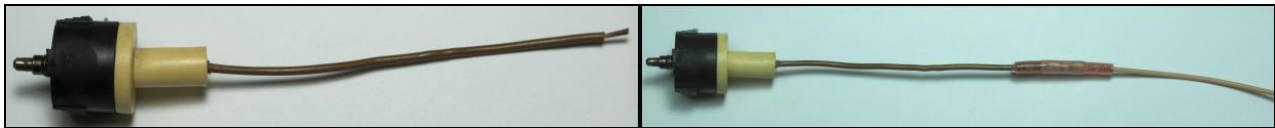

"Washer Pump"

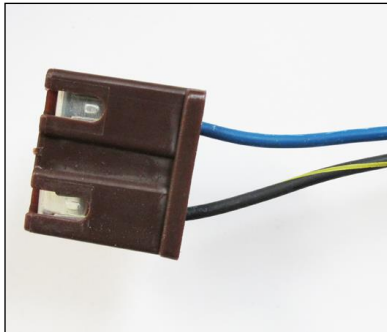

The next connection you come to in the **Light Section** is the "Washer Pump". The location of a reservoir mounted pump can be seen on p. 21. If you had to move this connection, as instructed on page 21, skip to the next connection.

The Washer Pump receives a ground signal from the wiper switch to activate the pump. Once activated, it will pump washer fluid from the reservoir to the washer nozzles at the base of the wiper cowl below the windshield.

Two wires are required for proper connection to the Washer Pump. This will be a 2 pin black connector on the Painless harness with a label reading "WASHER PUMP". The wires in this connector are:

Blue: 16 gauge wire printed with **#984 WASHER PUMP GROUND**, this wire will provide the Washer Pump with a ground source from the wiper switch when the switch is in the *Wash* position.

Black/Yellow: 16 gauge wire, printed **#983 WASHER PUMP POWER**, this wire supplies power to the Washer Pump from the 20 amp Wiper fuse on the fuse block. This wire will have power anytime the key is in the *ON/RUN* or *ACC* positions.

These wires can be seen in the [Wiper System Schematic](#) on p. 103.

- Connect these wires to the 2 tabs on the “Washer Pump”. When you’re finished with the complete install of the Painless harness and notice the washer pump is blowing bubbles into the reservoir instead of pumping fluid, simply reverse the connector on the pump and switch the power and ground.

“Left Side Marker”

The driver side fender mounted marker light is the next connection. It serves two purposes: it is a park light as well as a turn signal. The park light feature is activated by a power source coming from the headlight switch. This light will illuminate any time the headlight switch is in the *PARK* or *ON* position. The turn signal feature is provided by a power source coming from the turn signal switch.



The Left Side Marker requires two wires to work properly, seen in the [Front Lighting Schematic](#) on page 31. A factory style socket comes pre-installed and will have a label reading “LEFT SIDE MARKER”. The wires spliced to this molded connector are:

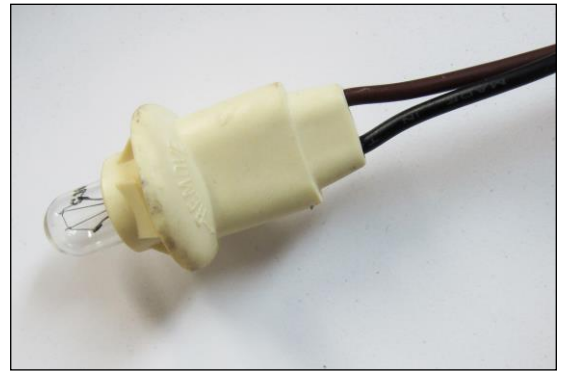

Brown: 18 gauge wire, printed **#927 PARK LIGHT POWER**, this is a power wire for the park or marker light function. This #927 is tied to the other #927 wires in the Light Section. This wire will have power anytime the headlight switch is in the Park/Tail Lights ON or Headlights ON position.

Light Blue: 18 gauge wire, not printed, this wire is the power for the turn signal function. This wire goes into a splice with the light blue wire going to the front left turn/park light and to a wire coming from the bulkhead. This wire will have interrupted switched power from the turn flasher any time the left turn signal is activated and interrupted battery power from the hazard flasher any time the hazard switch is in the ON position.

Inspect the pre-mounted bulb and ensure the filament is still intact.

- Looking at the back of the marker lamp housing you will see that it has a keyed opening to correspond with the tabs on the socket. (as seen in the photo)
- Insert the lamp socket of the Painless harness into the “Left Side Marker” housing and turn ¼ turn to lock the socket in place.



“Left Headlamp”

Your next connection in the **Light Section** will be the “Left Headlamp”. Removing the headlamp may be necessary and is recommended to ensure the terminals of the headlamp are not damaged during connection; they are easily bent if the connector is not installed correctly.

There are round openings in the core support to allow access to the terminals on the back of the headlamp if removal of the headlamp is not preferred. However, access to the tabs can be limited on some year models.

Three wires make up the connection to the Left Headlamp. These wires go into a black three pin connector. This group of wires will have a section label reading “LEFT HEAD LAMP”, these wires are:

Light Green: 14 gauge wire, not printed, this wire will provide power to the high beam filament of the head lamp. This wire goes into a splice with a wire going to the right headlamp and also to a wire going to the bulkhead and can be seen in the [Front Lighting Schematic](#) on page 31 . This wire will have power when the dimmer switch is in the high beam position and the headlight switch is in the headlight ON position.

Tan: 14 gauge wire, not printed, this wire will provide power to the low beam filament of the head lamp. This wire goes into a splice with a wire going to the right headlamp and also to a wire going to the bulkhead and can be seen in the [Front Lighting Schematic](#) on p.31 . This wire will have power when the dimmer switch is in the low beam position and the headlight switch is in the headlight ON position.

Black: 14 gauge wire, not printed, this wire provides a ground source for the headlamp. This wire is tied into the integrated ground circuit and can be seen in the [Ground Schematic](#) on page 15.

- Plug the connector into the back of the headlamp. Use caution while installing as the tabs on the headlamp will easily bend.



If halogen bulbs are being used Painless recommends using Painless part # 30815. This headlight relay kit is needed to avoid overloading the headlight switch with the higher demands of halogen bulbs.



“Ground”

The wire labeled “Ground” is the next connection in the install process. This wire is the ground wire for driver side head light and also supplies the ground source for the park/turn signal lamp of the 1974-1981 Camaros. See the [Ground Schematic](#) on page 15.

Locate the black wire with the ring terminal pre-installed, this wire will not have a label as it is clearly marked with its function.

Black: 14 gauge wire, not printed, this wire provides a chassis ground source for the headlamp as well as the rest of the integrated ground circuit. This wire can be seen in the [Ground Schematic](#) on page 15.

- Connect this wire to the core support where the factory ground wire was, next to the headlamp access hole. Makes sure the ground area is clean of dirt, rust and/or paint.



Also, take notice to the use of Painless Power braid, part # [70923](#), on the harness in the photo above.

“Left Turn/Park Light”

The last connection needing to be made before routing the [Light Section](#) across the core support is the “Left Turn/Park Light”. This light has a dual filament bulb that works as a turn signal as well as a park light. The turn signal will be the brighter of the two filaments.



New bulbs for the front Turn/Park Light have been supplied. The bulb this lamp requires has universal part number 1157A, replacement bulbs can be found at any auto parts store under this part number. **Clear 1157 bulbs cannot be used.** Amber bulbs must be used as laws require the front turn signals to be amber in color. Most vehicles have colored lenses to comply with this law, in which clear 1157 bulbs may be used. The front lamps of the second gen Camaro have a clear lens, so **these vehicles must use amber bulbs.**

The Left Turn/Park Light of the Painless harness consists of two connectors, a two pin and a single pin, these connectors will be identified by a label reading "LEFT TURN SIGNAL". These wires are:

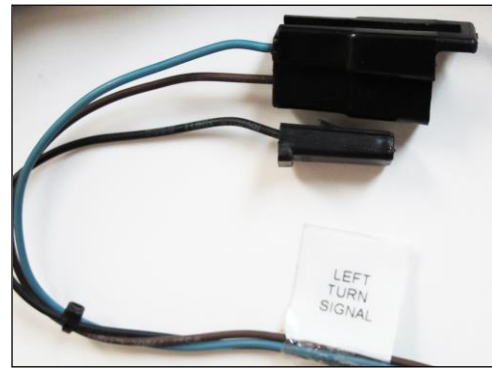

Two pin connector, (these wires can be seen in the [Front Lighting Schematic](#) on page 31)

Brown: 18 gauge wire, printed **#927 PARK LIGHT POWER**, is the power source for the park light. This #927 is tied to the other #927 wires in the Light Section. This wire will have power anytime the headlight switch is in the Park/Tail Lights ON or Headlights On position.

Light Blue: 18 gauge wire, printed **#926 FRONT LEFT TURN SIGNAL POWER**, this wire is the turn signal power. This wire goes into a splice with the light blue wire going to the front left marker light and to a wire coming from the bulkhead. This wire will have interrupted switched power from the turn flasher any time the left turn signal is activated and interrupted battery power from the hazard flasher any time the hazard switch is in the ON position.

Single pin connector

Black: 18 gauge wire, printed **#969 TURN SIGNAL GROUND**, this wire provides a ground source for the turn/park lamp. This wire is tied into the integrated ground circuit and can be seen in the [Ground Schematic](#) on page 15.

Your particular year model will determine the way this connection is made as the front turn/park lights of the Camaro varied during the 12 year production run. The photo below shows the 4 different light configurations and the years they were used.

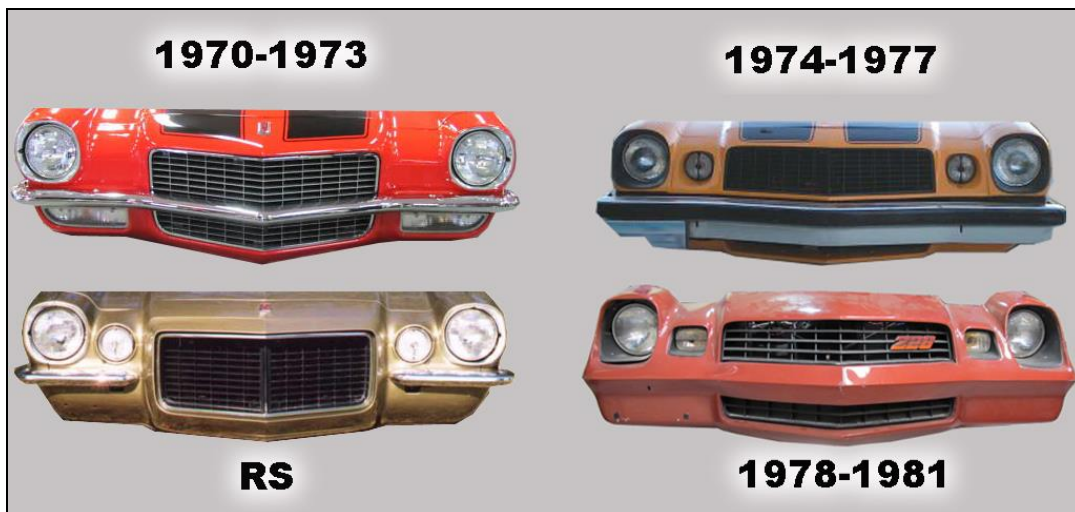

As the Painless harness comes out of the box, it will fit the 1970-1973 configurations, regardless if you have the RS or non RS Turn signals. Light socket pigtails have been included with part #20113 and #20114 that will plug into the Painless harness to work with 1974-1981 turn signals. Skip to the year range your particular installs fits.

1970-1973

The Turn/Park Light wires are crimped into the housing and have an external connector routing up and coming out of the top of the core support, as seen in the photo to the below. The 2 wires that come from this housing are purple and black: Purple being the Park Light wire and the Black being the Turn Signal.

You may notice now that there is no ground wire, this is because the bulb is grounded to the metal housing, which is grounded to the body through the mounting tabs. Even if everything was working properly before, remove the turn signal housing and clean these grounding/mounting tabs. This was discussed in the **GROUNDING** section of this manual on p.11.

- Connect the 2 pin connector into the factory connector coming from the Turn signal housing, seen in the picture to the right.
- The 1970-1973 will not use the single pin connector found on the Painless harness with the Black **#969 TURN SIGNAL GROUND** wire.



1974-1981

Included with your kit are 2 lamp socket pigtails with bulbs. These 2 pigtails are for the front Turn/Park Lights. They will plug directly into the Painless harness.



- Connect the pigtail to the 2 connectors on the Painless harness.
- Removal of the Turn Signal housing may be required in order to install the Lamp socket.
- Route the lamp socket through the core support. Before connecting, inspect both bulb filaments to make sure they have not broken during shipment of the harness. Connect the socket to the back of the lamp housing. It is a keyed opening and the socket will need to be rotated ¼ turn to lock it in place. Once connected, re-install the lamp housing.



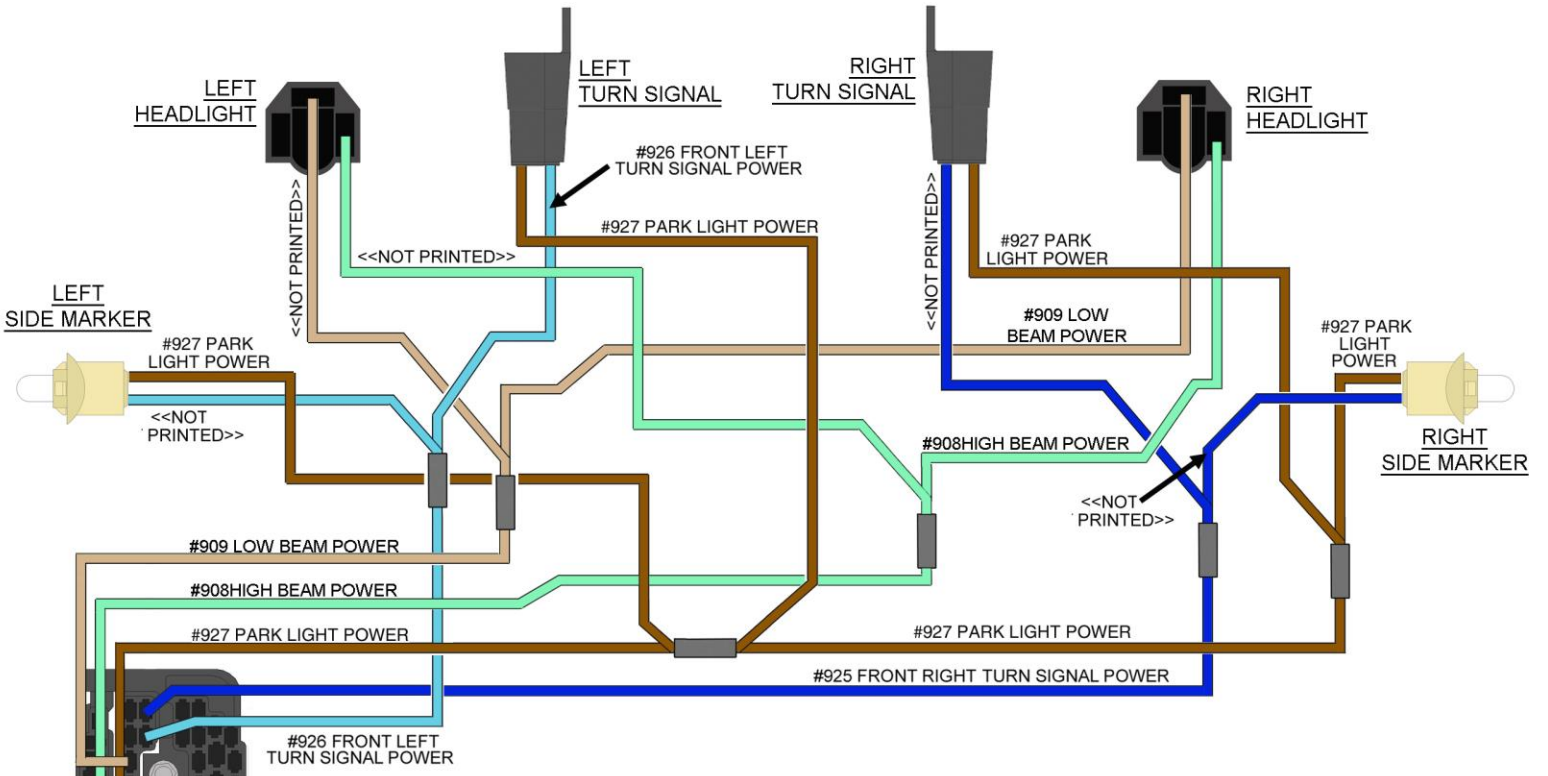

FRONT EXTERIOR LIGHTING

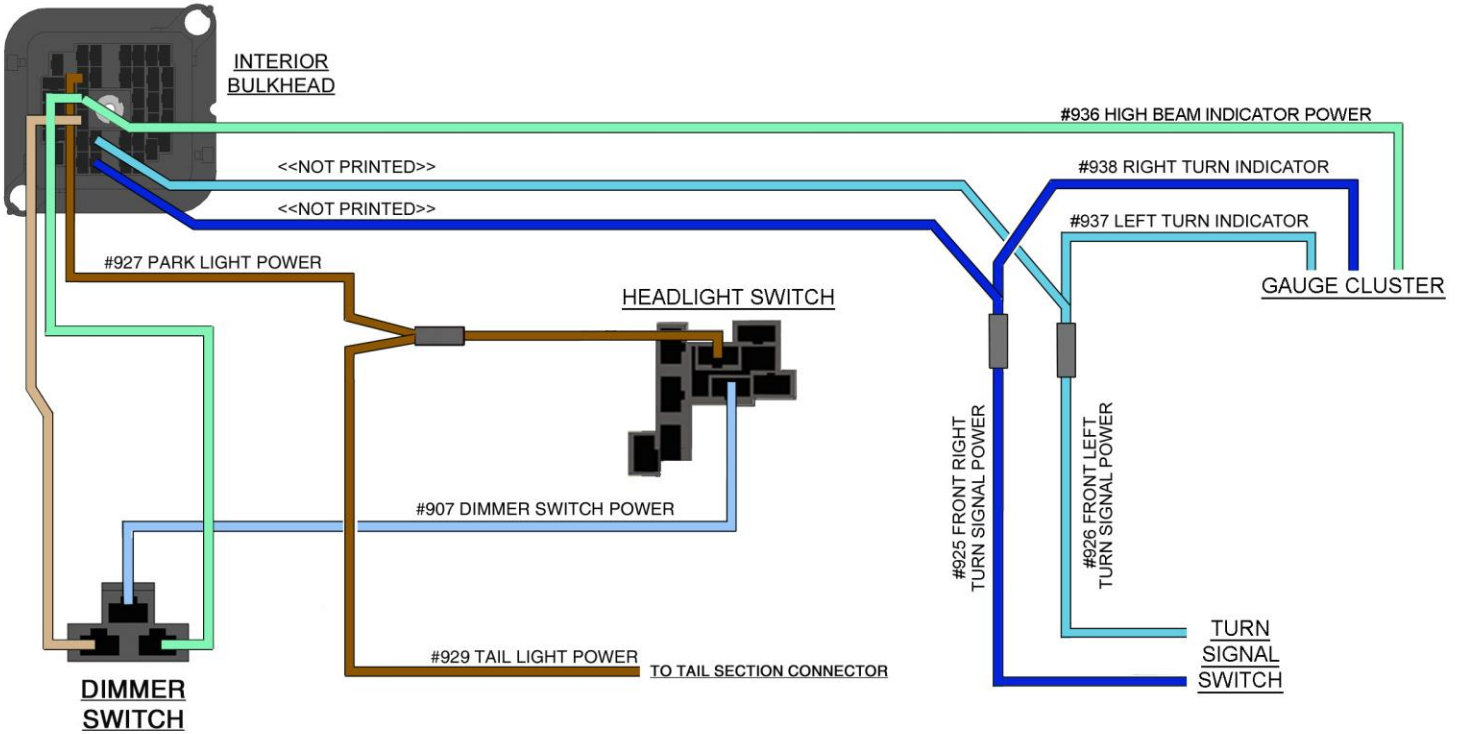

“Horns”

The **Light Section** now needs to be routed across the core support. In order to do this properly, the Radiator hold down must be removed; this will require a ½” socket or wrench. With the support removed you will now have access to the channel that runs along the top of the core support. This is a great place to make use of the umbrella zip ties included with kit as this channel has ¼” holes along the top.



Remember to loosely install the zip ties. The zip ties should not be tightened until all wires of the **Light Section** are connected.

Some vehicles have 1 horn, while others have 2. The Painless harness has provisions to attach to 2 horns, each connection is a single pin black connector, the connectors have a single wire:

Green: 16 gauge wire, printed **#924 HORN POWER**, these are power wires that come from the fuse block mounted horn relay which is ground activated by the horn button on the steering column. These wires will only have power when the horn button is pressed.

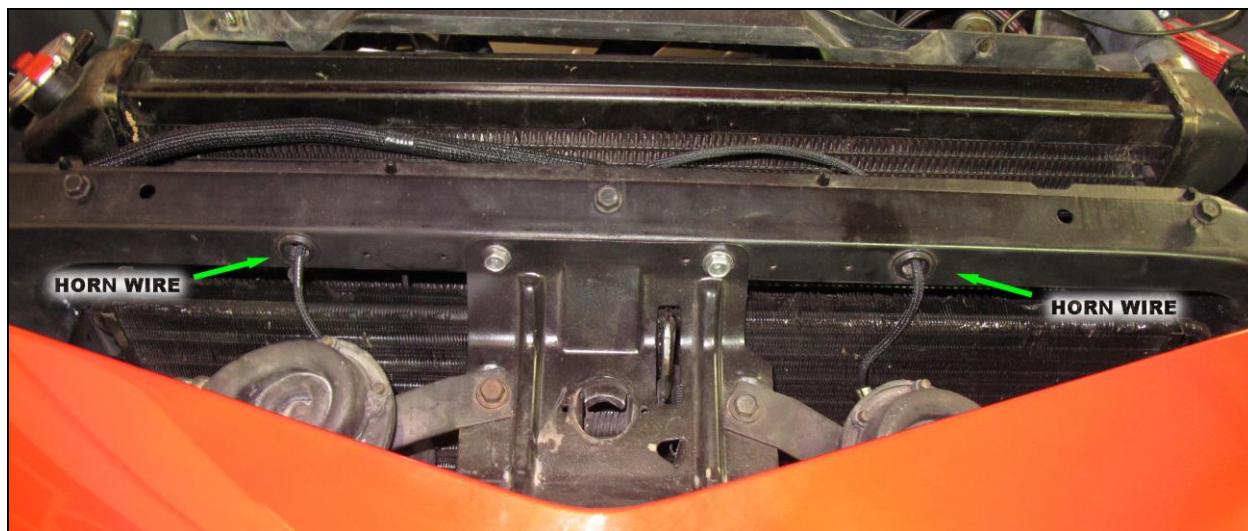

Vehicles that do not need both wires can simply zip tie the extra horn wire into the core support channel or cut the wire from the splice which is located about 6” into the main harness towards the driver side fender.

- Route the horn wire(s) through the small hole in the top of the core support towards the horn(s). In the parts kit you will find small grommets to fit these holes to protect the wires.
- Locate the connection tab on the horn and connect the horn wire(s) to the tab on the horn. Horns ground through their mounting so they only require a power connection.

“Right Turn/Park Light”, “Right Headlamp”, & “Right Marker Light”

The 3 connections mentioned above all connect in the same manner as those on the left side. The only difference you will find is the Turn signal wire for the right turn signal is a different color than that one used for the left turn signal. The right Turn signal will be an un-printed 18 gauge Blue wire.

“Ground”

The ground on the right side, or passenger side, of the vehicle is intended to connect directly to the negative side of the battery. This will tie all of the grounds found in the Painless harness directly back to the battery, as explained in the **Grounds** portion of this manual on page 11.

- Connect the 10 gauge Black wire, printed **#969 BATTERY "-"/ GROUND SOURCE** to the negative side of the battery. A ring terminal has been pre-installed for convenience however if a different terminal is required extra heat shrinkable ring terminals can be found in the parts kit.
- If the battery has been relocated to the trunk, connect this wire to the core support where the factory ground wire was connected, next to the headlamp access hole. Makes sure the ground area is clean of dirt, rust and/or paint.



This concludes all of the connections in the **Light Section** of the engine harness. Go back inspect the harness layout and once satisfied it is free of moving parts and sharp edges tighten any loose zip ties.

“Wiper Motor”

The Wiper Motor is mounted on the firewall. It receives ground signals from the wiper switch in order to operate. The power feeding the wiper motor comes from the 15 amp WIPER fuse and will have power anytime the key is turned in the “ON/RUN” position. The total connections at the wiper motor will depend on the type of wiper motor you have. Some will have the standard 2 speed wipers while some will have pulse/delay, particularly the later ‘76+ models. A Wiper Motor mounted washer pump will also affect the total number of connections needing to be made. The wires that make up the “Wiper Motor” connection can be seen in the [Wiper System Schematic](#) on p.105.

Locate the group of wires in the Painless harness labeled “Wiper Motor”. This will be two connectors, a 2 pin connector and 1 single pin connector, and two wires without a connector. The wires of the wiper motor connection are:

2 Pin Connector

Light Blue: 16 gauge wire, printed **#977 WIPER MOTOR (HIGH)**, this is a ground signal from the wiper switch.

Black/Yellow: 16 gauge wire, printed **#982 WIPER MOTOR POWER**, this wire will supply switched ignition power to the wiper motor from the 15 amp WIPERS fuse on the fuse block.

Single Pin Connector

Black: 16 gauge wire, printed **#979 WIPER MOTOR (LOW/PARK)**, this is a ground signal from the wiper switch.

2 wires with terminals pre-installed

Green: 16 gauge wire, not printed

White: 16 gauge, not printed

These Green and White wires will only be used by those using pulse/delay wipers.

- On the right side of the motor you will see 3 tabs sticking out; these are the connection points for the Wiper Motor.

Connect the 2 pin connector to the bottom 2 tabs. The light Blue wire should be on the bottom tab, the Black/Yellow on the middle tab.

Connect the single pin connector with the Black wire to the top tab.

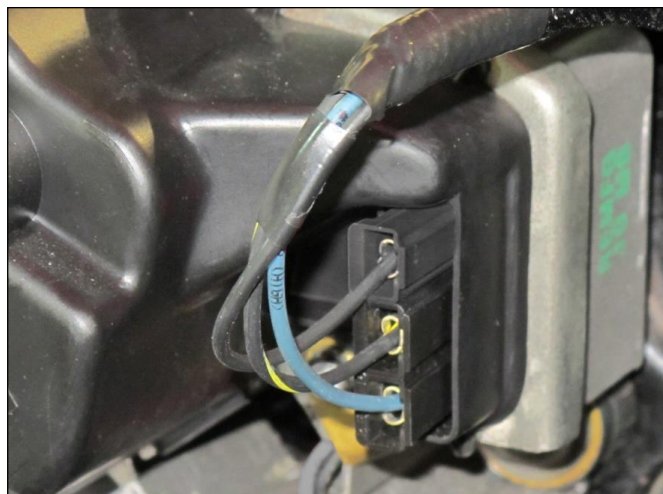

If you only have 2 speed wipers and your washer pump was located in the reservoir bottle, you may skip to the next portion of the instructions, **“Under Hood Light”** on page 34.

There were 2 different Delay Wiper Motors used during the production run of the 2nd gen Camaro. The use of one or both of the 2 remaining wires of the “Wiper Motor” group of wires will depend on the style of delay motor you have, pictured below.

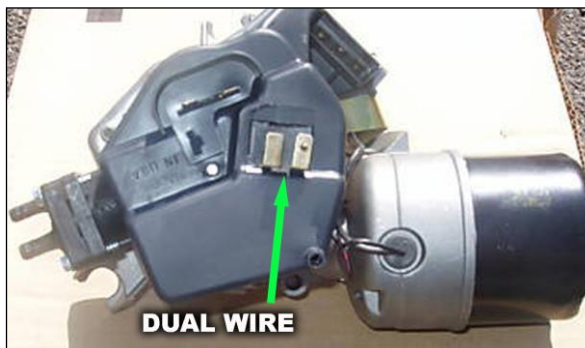

Single Wire

Only the Green wire will be used on the single wire delay pump. It will connect to the post under the 2 posts of the Washer pump.

- Locate the connector seen in the photo in the parts kit. Install this connector onto the terminal found on the Green wire.
- Route the 16 gauge Green Wire to the delay module connection point on the Wiper Motor and connect it to the Wiper Motor.



Dual Wire

Both the Green wire and the White wire will be used on this connection.

- Locate the black connector shown in the photo in the parts kit. There will be more than one of these connectors.
- Install this connector onto the terminals pre-installed on the Green and White wires.
- Once installed, route these wires to the 2 connection points on the front of the Wiper Motor and connect. The Green wire will go on the post on the right, closest to the actual Wiper Motor.



“Washer Pump”



If the “Washer Pump” connection was moved, the wires will be longer than the other “Wiper Motor” wires they are grouped with. You can leave this as is leaving the extra length in the harness, or for a much cleaner install you can cut the wires to length.

Terminals have been provided in the parts kit to allow cutting these 2 wires to the correct length for the firewall/wiper motor mounted washer pump; the connector(s) from the Painless harness or your factory harness will need to be re-used.

- Looking at the “Washer Pump” connector(s), you will notice a slot to allow access to the terminal locking tab. Insert a paper clip or a stiff piece of wire into this slot, as demonstrated in the photo on the next page on a connector similar to that of the washer pump. Before removing the wires, write down which wire goes to which pin.



- Push the paper clip/stiff wire in to depress the locking tang of the terminal. While pushing the wire into the slot, pull the harness wire from the connector. Do not pull too hard or you could pull the wire from the terminal, leaving the terminal stuck in the connector. Both wires of the “Washer Pump” should now be removed.
- Route the Blue and Yellow/Black wires of the “Washer Pump” to the 2 terminals for the Washer pump, located in the center of the motor and seen in the photo below. Cut the 2 wires to length, strip the insulation ¼”, and crimp on new terminals like those shown above.
- Install the connector previously removed onto the new terminals, and connect the “Washer Pump” wires to the washer pump. Make sure the Black/Yellow wire is connected to the post closest to the Wiper motor connections, the post the arrow is pointing to in the photo below.

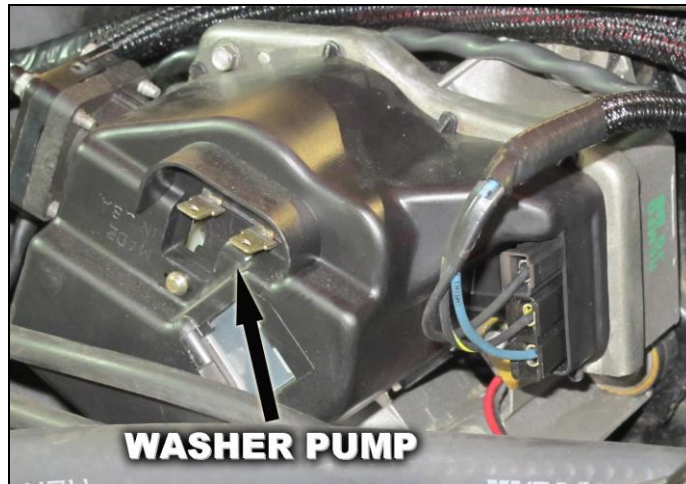

“Under Hood Light”

For those with an under hood light, this next connection will supply the power wire this light requires.

Coming from the bulkhead, locate the wire with a section label reading “UNDER HOOD LIGHT”. This will be a single wire with a black single pin connector, this wire is:

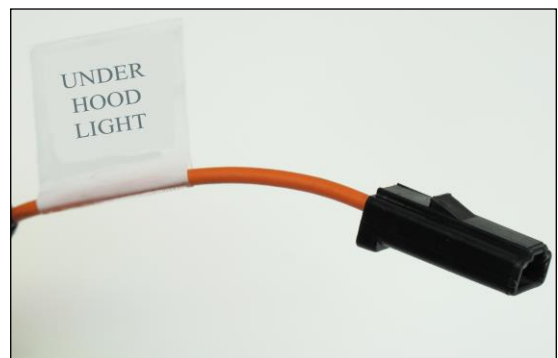

Orange: 16 gauge wire, printed **#979 UNDER HOOD LIGHT**, this wire provides battery power to the under hood light. This power comes from the 10 amp DOME fuse. This wire can be seen in the [Courtesy/Dome light Schematic](#) on page 71.

A mating connector and terminal have been supplied in the parts kit to allow you to add a connector to the factory wire coming from the under hood light. This terminal will require the use of a pair of rollover crimpers, like those seen on page 8, to install the mating terminal and connector:



- Remove the factory splice from the under hood light, this will be the cylindrical piece of rubber where the black and orange wire meet. This will leave you with a wire about 24" long.
- Strip ¼" of insulation from the black wire of the under hood light and crimp the terminal on. This terminal is very stiff and can be difficult to crimp. If you find that the crimpers you have just can't get the job done, you can fold over the tabs onto the wire and wire insulation using a pair of pliers, be careful not to over crimp.
- Once crimped, insert the terminal into the small end of the connector.

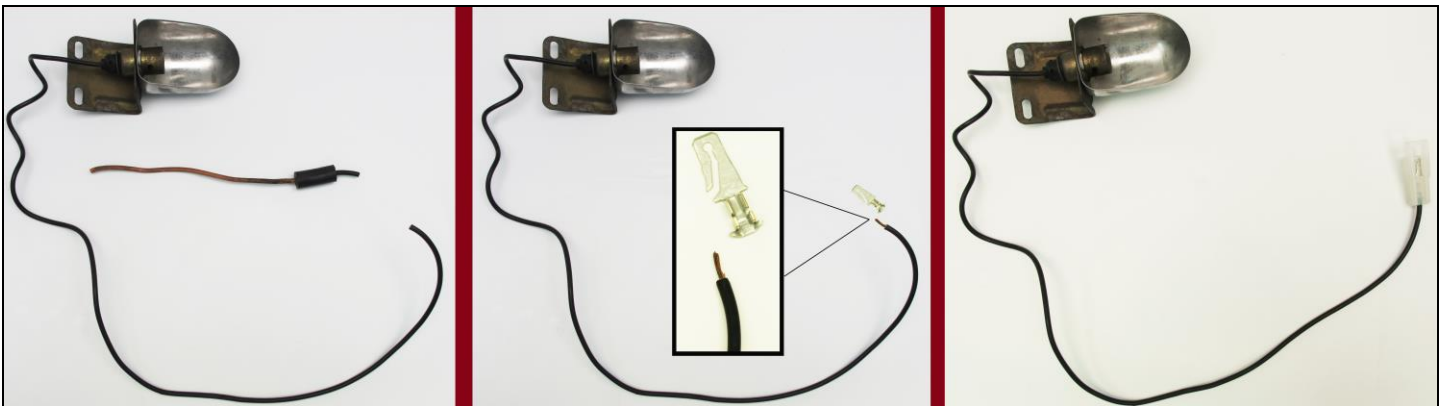

With the mating connector now installed you can make the connection to the under hood light.

- Route orange **#979** wire to the under hood light and connect the Painless chassis harness to the modified under hood light. Be aware of pinch points like around the hood hinges and where the hood closes at the cowl.

Engine/Ignition Section

The **Engine/Ignition Section** consists of six wires for connections to oil pressure and coolant temperature sending units for the gauges, connections to the coil or ignition system, and a connection for an electric choke on a carburetor. Locations of all of these components will vary from vehicle to vehicle so no specific routing instructions can be given.

All wires of the **Engine/Ignition Section** are open ended wires, meaning they do not have terminals or connectors pre-installed. This is because all wires have ample length to account for the numerous way components can be mounted inside an engine compartment. For example: an Ignition box mounted on the inner fender will require more length of wire than if power was going to a firewall mounted coil.

Coil/Ignition

3 of the 6 wires of the **Engine/Ignition Section** are for Coil/Ignition connections. Usage of only one or all these wires will depend on the components used in your particular installation. All wires can be seen in the diagrams on pages 39 & 40. The three wires intended for the Coil/Ignition connections are Pink/Black, Yellow, and Brown.

“Coil Power”

Locate the 16 gauge Pink/Black wire, it will be printed with **#920 COIL POWER ("+")** and be considerably longer than the other wires found in this section. This wire comes through the bulkhead from the 20 amp COIL fuse. This wire will provide the Coil or ignition system with switched power in one of four ways:

- If the Coil you are using is not internally resisted, a ballast resistor along with the Yellow wire mentioned in the next step, must be used. A ballast resistor, provided in the kit and seen to the right, resists the current going to the coil. **If a coil is not internally resisted and a ballast resistor is not used the coil will overheat within a few minutes to the point it will no longer work.** See the

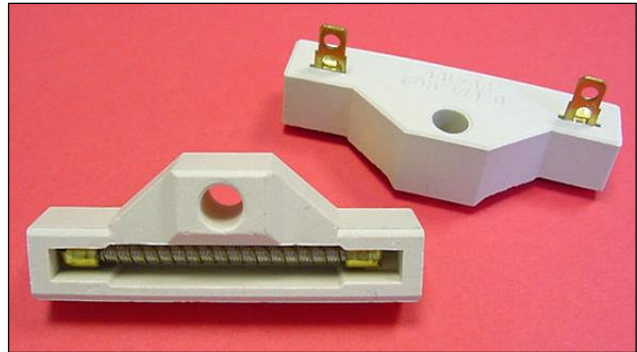

[*Ballast Resistor Connection Diagram*](#) on the next page.

- HEI coils, internally resisted coils, and most aftermarket ignition boxes do not require the use of a ballast resistor. The **#920** wire will connect directly to the + side of the coil. See the [*NO Ballast Resistor Connection Diagram*](#) on page 40.
- If an aftermarket Ignition box is being used, like an MSD, Accel, etc., this Pink/Black **#920** wire will supply the Ignition box with the switched power source it requires. This wire will go to the aftermarket ignition box and **not the Coil**; the Ignition Box will provide the Coil + connection. This Pink/Black **#920** wire may need to be pulled from the **Engine/Ignition Section** and routed to where the box is mounted; extra length has been added to the **#920** wire to accommodate different mounting locations of the box in the engine compartment. See the Ignition box manufacturer's instructions for a specific connection point of this power source. See [*MSD Ignition Connection*](#) on page 40.

- If you have converted to fuel injection and are using a standalone harness, like all of Painless' fuel injection harnesses, and coil power is supplied though the fuel injection harness, like in LT1/LS1 and newer applications, this Pink/Black wire will provide the fuel injection harness with the switched power source the harness requires. If using a Painless fuel injection harness, this Pink/Black **#920** wire will connect to the open ended Pink wire of the fuel injection harness labeled "IGN" or "Fuse Block IGN".

- Route this Pink/Black **#920** wire to its proper connection point and cut to length, install the appropriate terminal for your connection, and connect.

Terminals and a factory style connector, seen in the photo at right, have been supplied to allow connecting to the + side of a HEI Coil. Rollover crimpers will be needed to properly install this terminal. Insulated terminals in the parts kit have been supplied to make connections to other Coils.



An added bonus of the coil fuse is it also provides a built in theft deterrent. Removing the COIL fuse from the fuse block when the car is parked for periods of time will not allow the ignition system to function, making the vehicle impossible to start/run.

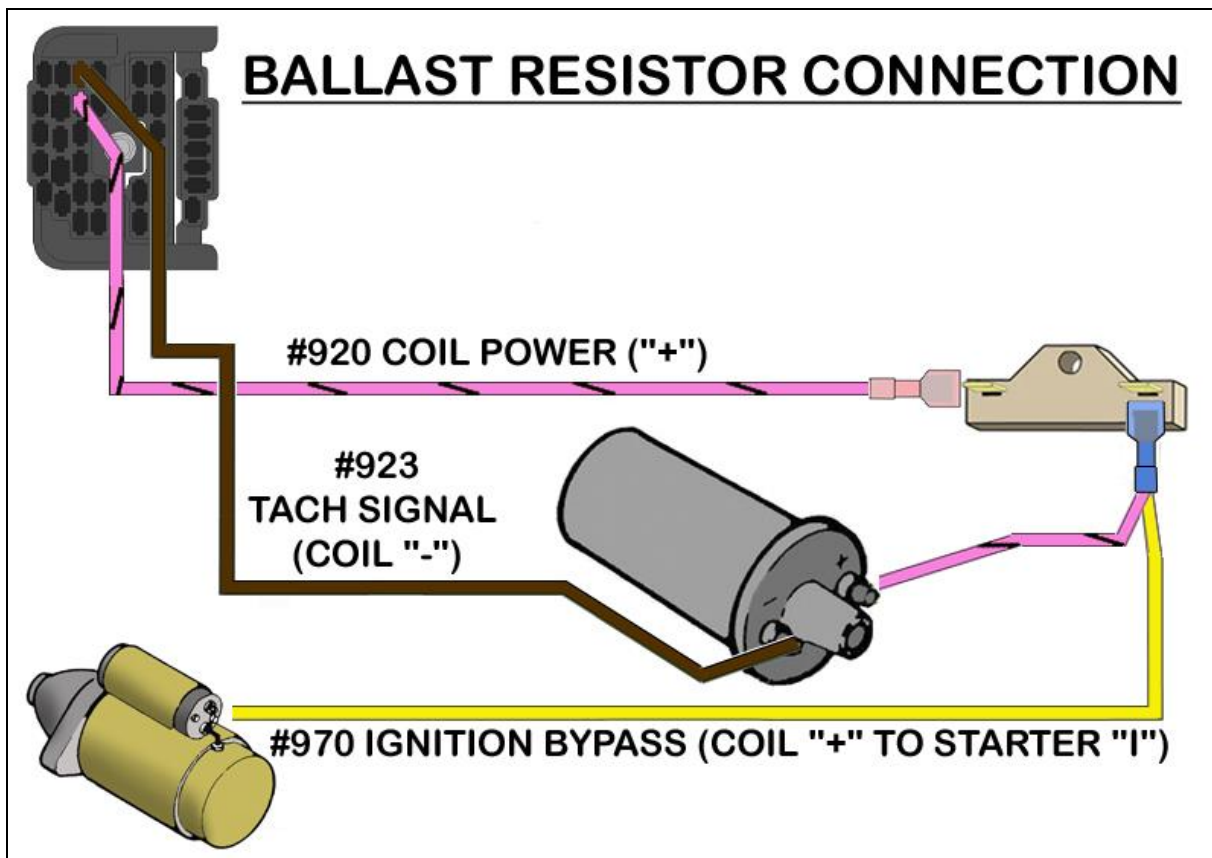

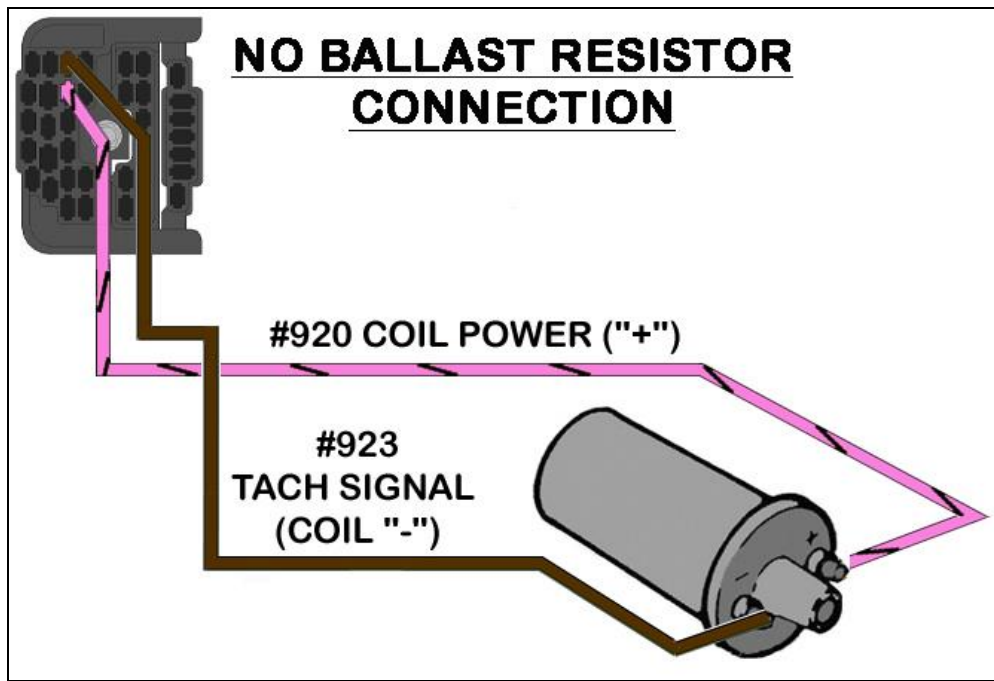

MSD IGNITION CONNECTIONS

ANALOG

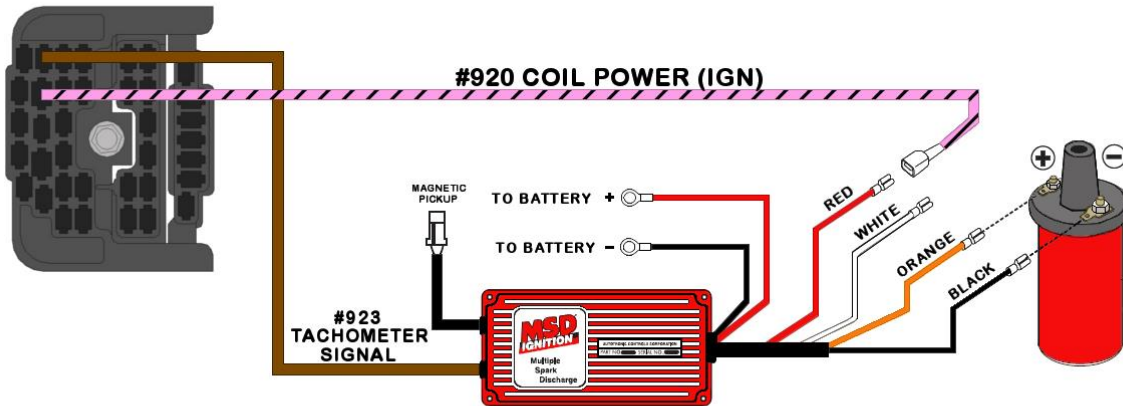

DIGITAL

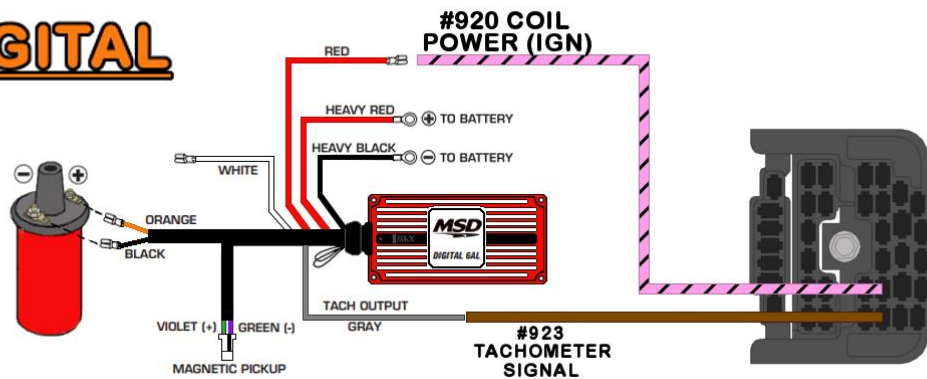

“Ignition Bypass”

Locate the 16 gauge Yellow wire printed **#970 IGNITION BYPASS (COIL "+" TO STARTER "I")**. This wire comes from the starter solenoid and will provide the coil full 12v of power when the starter solenoid is engaged by bypassing the ballast resistor and going directly to the coil. This is done to facilitate starting the engine and will not harm the coil. If connected to the starter, as indicated on page 52, this wire will only have power when the ignition switch is in the START or “crank” position.

This wire will only be needed if you are using a ballast resistor. Most installs will not need this wire and it can be removed from the harness; the other end can be found in the group of wires labeled **Starter**.

- Route the Yellow **#970** wire to the + side of the Coil or to the output side of the Ballast resistor. The [Ballast Resistor Connection Diagram](#) on page 39 has been created to aid in this connection.

“Tachometer”

Locate the 18 gauge Brown wire printed **#923 TACH SIGNAL (COIL "-")**. This wire will send tachometer signal through the bulkhead into the interior of the vehicle to the gauge cluster. This wire will only be connected if you are using a tachometer (factory or aftermarket). If you do not have a tachometer, this wire may be removed from the harness. Depending on your ignition system (factory or aftermarket) or use of fuel injection, the connection of this **#923** wire can vary:

- Standard factory type of installs with a HEI distributor or external coil ignition systems, will require this **#923** wire to be connected to the negative “-” side of the coil. Refer to the [No Ballast Resistor Connection Diagram](#) on the previous page.

Terminals and a factory style connector have been supplied to allow connecting to the - side of a HEI Coil, seen in the photo at right, rollover crimpers will be needed to properly install this terminal. Insulated terminals in the parts kit have been supplied to make other connections.

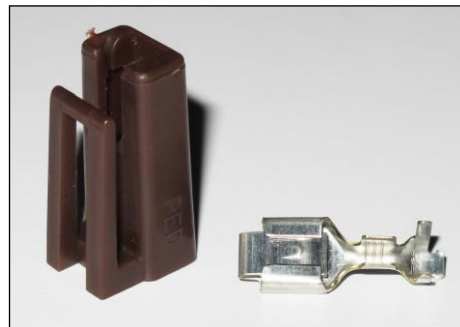

- If you are running fuel injection and your ECM has a tach output wire, this **#923** wire will connect to the tach output wire from the ECM.
 - If an aftermarket ignition box is being used, like an MSD, Accel, etc., this **#923** wire will connect to the tach output found on the ignition box. Refer to the [MSD Ignition Connection](#) on the previous page and to the ignition manufacturer’s installation procedure.
- Route this Brown **#923** tach signal wire to its proper connection point and cut to length, install the appropriate terminal for your connection, and connect.

Engine Sending Units/Switches

The engine should have 2 gauge sending units or 2 indicator light switches mounted to it; coolant temp and a oil pressure. If you are using aftermarket mechanical gauges, then no connections will need to be made. You can skip to the next connection, "Electric Choke" on page 41.

Cars with actual gauges, factory or aftermarket electric, have sending units. Sending units work based on resistance to ground. Meaning the cooler the engine or less oil pressure seen, the more ground (less resistance) these sending units will provide to the wire connected to them. As the ground resistance strengthens as the temps and/or pressure builds, less ground is applied to the gauge. As the ground signal weakens, the needle on the gauge moves to read higher temps and/or higher oil pressure. If you were to not connect these at all, the gauges would peg to their highest reading.

Cars equipped with a factory indicator light dash have switches instead of sending units. These switches simply send a ground signal to the light to turn it on when the temperature is high or oil pressure low enough to cause the switch to close.

"Coolant Temp"



Locate the 18 gauge Green wire printed **#921 COOLANT TEMPERATURE SIGNAL**. This wire will send a ground signal through the bulkhead into the interior of the vehicle to the gauge cluster and aftermarket gauge connector. If you are using an aftermarket mechanical gauge, this wire will not be used. This wire will work with aftermarket electrical gauges and senders.

The coolant temp sending unit/switch can be mounted in the intake manifold or in the side of either cylinder head. These will have a peg, tab or threaded post to connect to. Two wire temperature sensors on fuel injected engines that have weatherproof connectors are for engine computer input, not for gauge signal. Also, if connecting to an engine in a vehicle that has electric fans, make certain you know the difference between the coolant temp sensor and the electric fan thermostatic switch. Both of these sensors can look identical.

If you are installing a new temp sensor, or are unsure of the temp sensor currently mounted in your engine, make sure there is no tape/sealant on the sensor threads. The tape/sealer will interfere with the ground source the sensor needs to read correctly.

- Route this Green **#921** wire to the coolant temp sensor, cut to length, install the appropriate terminal for your connection, and connect.

Terminals and a factory style connector, seen in the photo to the right, have been supplied to allow connecting to a factory style sensor, rollover crimpers will be needed to properly install this terminal.



“Oil Pressure”



Locate the 18 gauge Blue/White wire printed **#922 OIL PRESSURE SIGNAL** and the 18 gauge Black wire printed **#969 OIL PRESSURE SWITCH GROUND**.

The **#922** wire will send a ground signal from the sending unit/switch through the bulkhead into the interior of the vehicle to the gauge cluster and to the aftermarket gauge connector. The black **#969** wire will provide a ground source to oil pressure switches.

The oil pressure sending unit will generally be located near the oil filter. On later model fuel injected engines this pressure sensor will generally be found at the back the engine behind the intake manifold.

Cars with actual gauges, factory or aftermarket electric, will have one wire sending units, like shown in the photo on the previous page. Cars using these types of sending units will not use Black #969.

- Route this Blue/White **#922** wire to the oil pressure sending unit, install the appropriate terminal for your connection, and connect.

Terminals and a factory style connector, seen in the photo to the right, have been supplied to allow connecting to a one wire, “stud” style sensor. Rollover crimpers will be needed to properly install this terminal.



- Black **#969** will not be used. This wire can be connected to a ground source on the firewall. **DO NOT connect this unused wire to a ground on the motor.** In the event your motor is not properly grounded, starter voltage could try to pass through this small 18 gauge wire.

Indicator light clusters require a 2 wire switch, which require both the black **#969** ground wire and the Blue/White **#922**. This switch is specific to the indicator light clusters. If you have a 2 wire sensor on a newer fuel injected donor engine it will not work for your indicator light cluster. 2 wire sensors on fuel injected engines are for fuel pump control and are not designed for oil pressure gauge readings. These types of sensors are generally found on GM TBI and TPI engines.

- Route this Blue/White **#922** and Black **#969** wires to the oil pressure switch, reuse the factory connector (molded onto the factory harness) or install insulated terminals for your connection, and connect.

“Electric Choke”

Locate the 18 gauge Blue wire printed **#954 CHOKE POWER**. This wire will provide a switched ignition power source to the choke from the 10 amp CHOKE fuse. This wire will have power when the ignition switch is in the ON/RUN position.



When you turn your key to the “ON/RUN” position, the voltage this wire carries will heat the bi-metal spring attached to the shaft of the choke. This spring will unravel as it is heated causing the choke to slowly open. When the ignition is turned to the “OFF” position, power is no longer on this wire, causing the spring to begin to cool and contract, closing the choke.

If you do not have an electric choke, or even a carburetor, this wire will not be needed and can be removed from the harness. It can also be used to power an aftermarket accessory or a factory component not supported by the Painless harness, like the Turbo 400 TCS relay.

- Route this Blue **#954** wire to the + terminal of the electric choke, install the appropriate terminal for your connection, and connect.

Ensure the choke is properly grounded, ground wire not supplied in the Painless harness, before continuing with the installation.

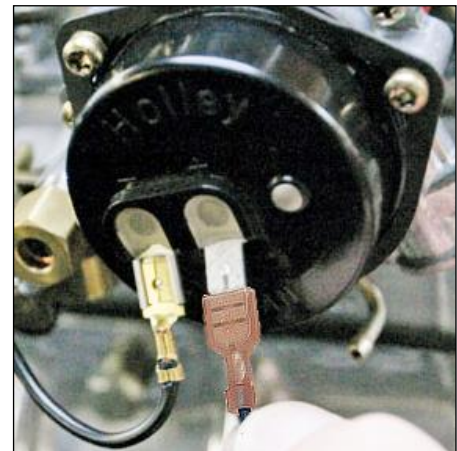

START/CHARGE Section

The Start/Charge Section consists of six wires for connections to the alternator, starter solenoid, and in line MIDI fuse (included with the kit). Locations of all of these components will vary from vehicle to vehicle so no specific routing instructions can be given.

All wires of the Start/Charge Section are open ended wires, meaning they do not have terminals or connectors pre-installed. This is because all wires have ample length to account for the numerous way components can be mounted inside an engine compartment. For example: the alternator can be mounted on either side of the engine depending on what engine or accessory brackets you are using.

The large gauge wires provided in the Start/Charge Section are 4 gauge wires. Taking the under-hood heat into account, these wires will support up to 160 amps.

“Alternator”

The alternator connections will vary depending on the alternator your vehicle currently has installed. The alternator may also need to be removed in order to gain access to the connection points.

- Before removing the alternator from the accessory bracket, route the alternator wires to their connection points and cut to length.

1970-1972 vehicles originally had an external voltage regulator, however most have been changed over to the internally regulated 10-SI or 12-SI alternator. The 1973-1981 came from the factory with the internally regulated 10-SI alternator. If your vehicle has had a motor swap or has had the accessory brackets updated to a serpentine system your vehicle will have a newer style alternator: CS-130, CS-144, or CS-130D.

Locate the bag kit provided with the Painless harness labeled “ALTERNATOR”. This bag kit will contain hardware needed to make the appropriate connections to the alternator as well as contain a covered inline fuse holder.



Locate the three wires intended for alternator connections; they will be grouped together in the Start/Charge Section. These wires are:

Red: 14 gauge wire, printed **#995 ALTERNATOR BATTERY POWER SAMPLE**, this wire will provide a battery power source, or amperage sample that some voltage regulators require. This wire will have power at all times and comes from the large battery supply splice in the harness. **This wire will not be needed if you have a one wire alternator or any of the CS series alternators.** See [Charge/Battery Power Schematic](#) on page 54.

Brown: 16 gauge brown wire, printed **#914 ALTERNATOR EXCITER**, this wire can have switched ignition power directly off the ignition switch (cars with factory clusters with a voltage gauge or switched ignition power from the 15 amp GAUGE fuse (cars with factory indicator light clusters). There are two connectors in the gauge cluster section that will determine how this wire is powered. This will be handled on page 83. In the event you have a one wire alternator, nothing will be done to the connectors, and there will be no power on this wire. **This wire will not be needed if you have a one wire alternator.**

Red: 4 gauge wire, with a label printed **#915 ALTERNATOR OUTPUT**, this wire will provide power out of the alternator to the chassis harness and back to the battery through the MIDI fuse. This wire will have power at all times and comes from the large battery supply splice in the harness. See [Charge/Battery Power Schematic](#) on page 54.

The one connection all alternators will have in common is the output post. This will send amperage from the alternator to the battery. This connection will be made using the large 4 gauge wire with the label reading **#915 ALTERNATOR OUTPUT**.

- Route this **#915** wire to the alternator output post and cut to length.

- Locate the rubber alternator boot and a large un-insulated ring terminal from the "ALTERNATOR" bag that has the right size opening for your alternator post. The piece of red heat shrink may be used along with the boot or just by itself over the terminal crimp if the alternator boot is not desired.



- If the rubber boot is being used, the end will need to be cut as shown in the photo below to allow the large gauge wire to pass through.



- If the heat shrink is being used, slide it onto the **#915** wire, followed by the rubber boot. A very small amount of lubricant like WD-40 or motor oil may be applied on the inside of the rubber boot to allow the boot to slide down the wire easier.

- With the boot on, strip about $\frac{1}{4}$ " of insulation from the charge wire and crimp the ring terminal on. You can use a pair of pliers if your crimpers will not accept this large gauge wire/terminal.



- Connect this wire to the B+/Output stud on the Alternator. Once the nut is on the stud on the output post has been tightened, the boot can now be slid up the wire to cover the nut and ring terminal installed on the Alternator. The heat shrink can be slid over the end of the boot and shrunk down.

Be advised this heat shrink will have to be removed before the rubber boot can slide back down the wire if the charge wire is ever to be removed.

If your vehicle has an aftermarket one wire alternator or if the Painless or other aftermarket fuel injection harness you are using has an alternator connector, then this output wire is the only wire used to make the alternator connection. The two remaining wires, a 14 gauge red wire printed **#995 ALTERNATOR BATTERY POWER SAMPLE** and a 16 gauge brown wire labeled **#914 ALTERNATOR EXCITER**, can be removed from the harness. **#995** may be connected to the output post of the alternator to avoid removing it from the harness since this wire goes into the big battery power splice.

The remaining alternator connections will vary based on what alternator is being used. Choose the alternator that best represents the alternator found on your vehicle from the 10-SI, CS-130 and CS-130D information on the next few pages and follow the instructions provided for your particular alternator.

SI Series Alternators



The 10-SI and 12-SI alternators are easy to identify. They will have an external fan behind the pulley, the 12-SI having enclosed style fan blades, and a two pin connection. This 2 pin connection can be seen on the middle image in the diagram above. These are also known as “Delco” or “Delcotron” alternators.

The two remaining wires, a 14 gauge red wire printed **#995 ALTERNATOR BATTERY POWER SAMPLE** and a 16 gauge brown wire labeled **#914 ALTERNATOR EXCITER**, will connect to the two posts on the back edge of the alternator.

- Route the two wires to the 1 & 2 terminals on the alternator and cut to length. Strip $\frac{1}{4}$ " of insulation from both wires.
- A factory style connector and terminals, seen in the photo, have been provided in the “ALTERNATOR” bag. Crimp a terminal onto each of the two wires.
- Insert the wires into the connector as shown in the diagram below. When terminal pin-out is complete, plug the connector into the alternator.



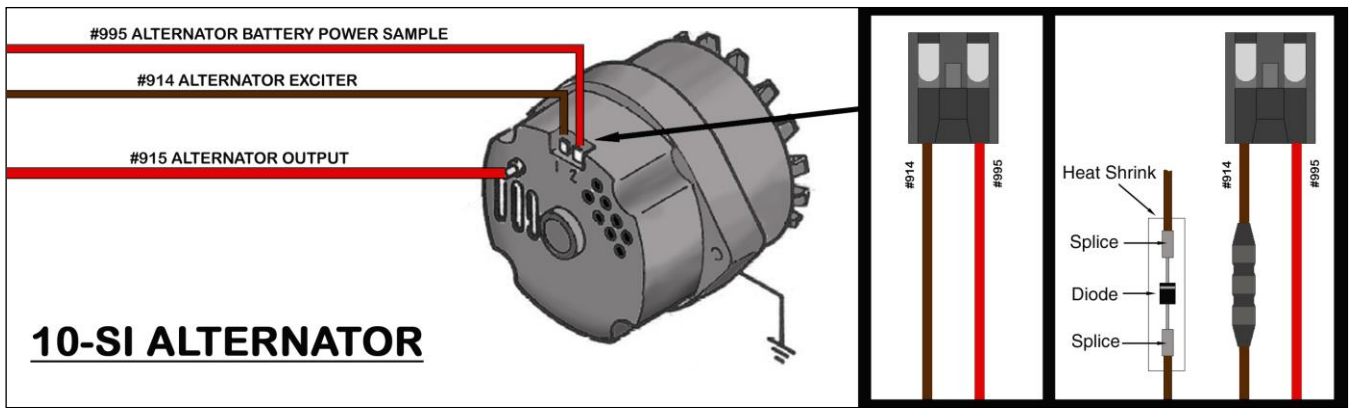

You may experience engine run on. This is caused when the alternator back feeds voltage down the **#914** wire after the key has been turned off. This allows the ignition system to still function causing the engine to continue running even though the key is turned off or even removed from the ignition. If this should happen unplug the alternator connector to shut the engine off. A remedy can be found on the next page.

As shown in the photo and diagram on the previous page, a diode, splices and heat shrink have been provided to remedy this issue. If engine run on occurs, simply install the diode as shown on the previous page. When the diode is installed inline of the **#914** wire **with the stripe towards the alternator**, the diode will let voltage flow towards the alternator, but not away from the alternator towards the ignition system,

CS-130 Series Alternators



The CS-130, CS-121 and CS-144 alternators closely resemble the SI series alternators. They will have an external fan behind the pulley and they generally have some plastic casing on the side and back. These alternators have a four pin sealed connector, seen in the photo below and in the middle image above. The regulator will be marked P,L,S,F. This type of alternator was used on GM TPI and LT1 fuel injected engines among other late 1980's to mid 1990's GM vehicles.

The two remaining wires, a 14 gauge red wire printed **#995 ALTERNATOR BATTERY POWER SAMPLE** and a 16 gauge brown wire labeled **#914 ALTERNATOR EXCITER**, will connect to the regulator on the back of the alternator.

- Route the two wires to the connector on the alternator and cut to length. Strip ¼” of insulation from both wires.

- The 4 pin alternator connector from the harness removed from the vehicle prior to installation of the Painless harness (see photo), will need to be used. Due to a lack of usage by most customers it is not included with this Painless chassis harness.

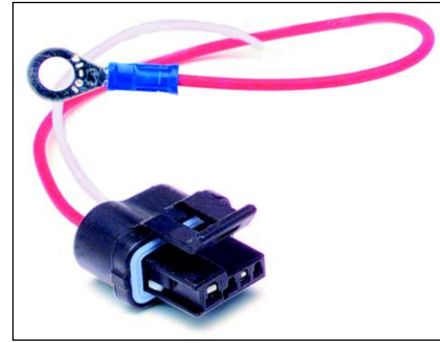

- The CS-130 alternator requires a resistance on the #914 wire. Without this resistance the regulator on the alternator will burn up. A resistor, splices, and heat shrink, seen on the next page, have been provided in the “ALTERNATOR” bag kit. The resistor* will simply need to be installed inline on the #914 wire as shown in the diagram on the next page.

*In factory applications where this alternator was used this resistance was created through a charge indicator light. For those with an instrument cluster consisting of indicator lights instead of gauges or those with a charge indicator light, the resistor will not be needed.

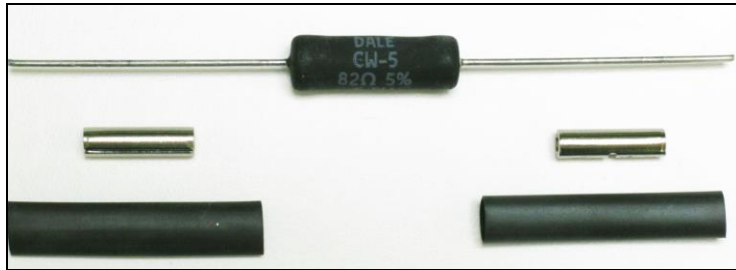

- Using two of the splices and heat shrink provided in the “ALTERNATOR” bag kit, splice the CS-130 pigtail to the #914 and #995 wires according to the diagram below.

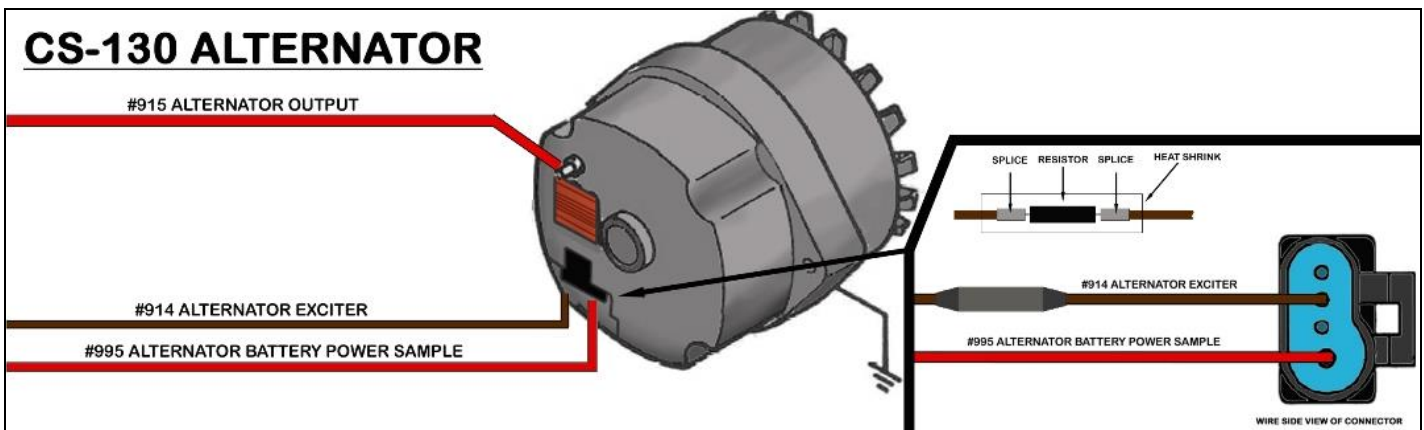

CS-130D Series Alternators

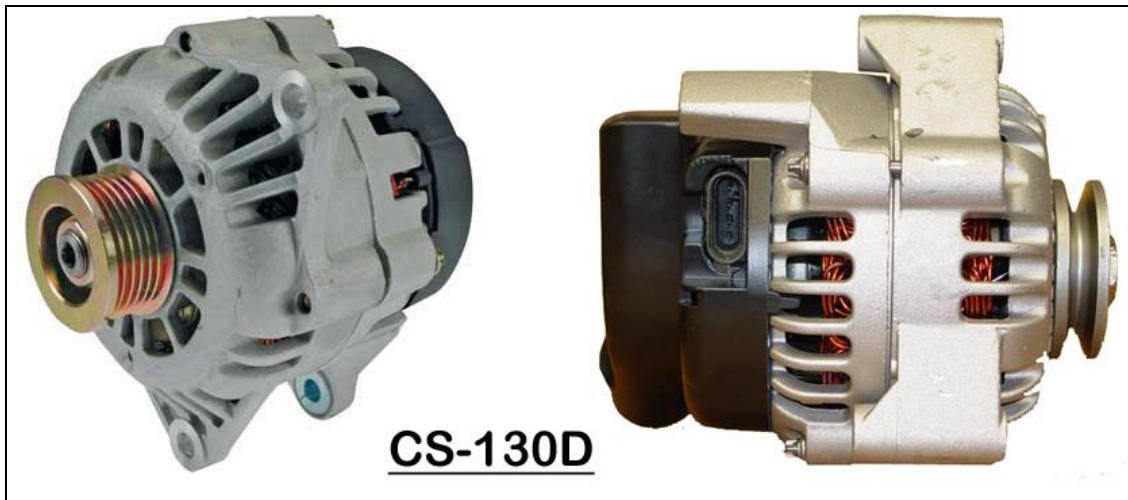

The CS-130D can be spotted by their lack of an external fan behind the pulley. These alternators have an internal fan. They also have a plastic casing on the back. These alternators have an elongated oval, four pin sealed connector, seen in the photo on the next page and in the image above. The regulator will be marked P,L,I,S. This type of alternator was used on many engines, including the GM LS series, Vortec and Gen. III Vortec truck fuel injected engines.

Of the two remaining wires, a 14 gauge red wire printed **#995 ALTERNATOR BATTERY POWER SAMPLE** and a 16 gauge brown wire labeled **#914 ALTERNATOR EXCITER**, only the **#914** will be used. The **#995** may be connected to the alternator output post or removed from the harness.

- Route the brown **#914** to the connector on the alternator and cut to length. Strip ¼" of insulation.

- The four pin alternator connector from the harness removed from the vehicle prior to installation of the Painless harness or a CS-130D pigtail purchased from Painless, [part # 30708](#) (see photo), will need to be used. Due to this connector being provided on most fuel injection harnesses, this connector is not included with this Painless chassis harness.



- The CS-130D alternator requires a switched power source to pin I of the regulator, and a resistance on the wire going to pin L of the regulator, the brown wire in the photo above. Without this resistance the regulator on the alternator will burn up. A resistor, splices, and heat shrink, seen on the previous page, have been provided in the "ALTERNATOR" bag kit. The resistor* will simply need to be installed inline on the L pin wire as shown in the diagrams on the next page.

*In factory applications where this alternator was used this resistance was created through a charge indicator light. For those with an instrument cluster consisting of indicators lights instead of gauges or those with a charge indicator light, the resistor will not be needed. And the brown #914 will connect directly to the wire connecting to pin L of the regulator. If this is done, an un-resisted switched ignition source will need to be run to pin I of the regulator. See page 18 for a switched power source and the diagram below

- Using a splice and heat shrink provided in the “ALTERNATOR” bag kit, splice the CS-130D pigtail to the brown #914 wire according to the diagram below and on the next page that best reflects your application.

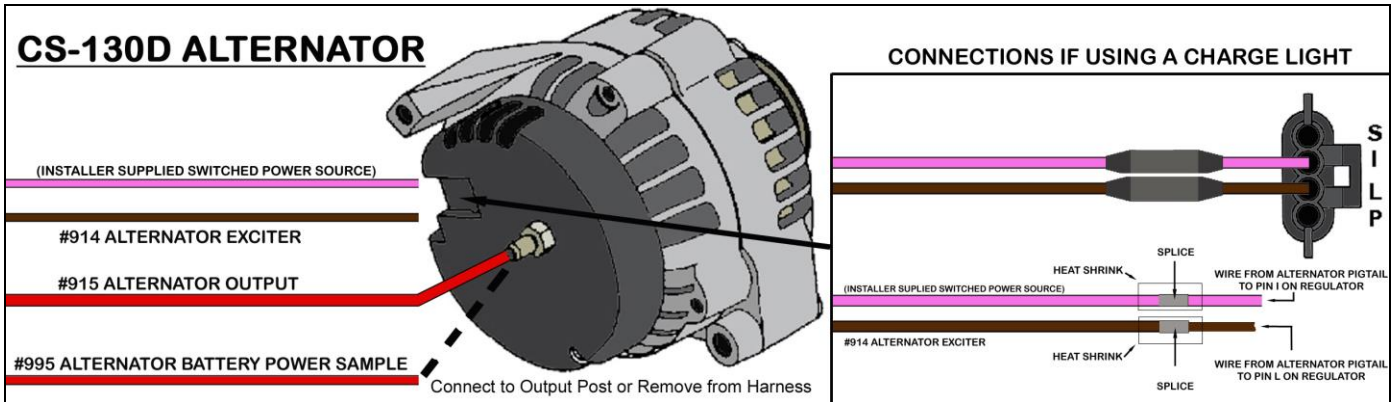

USE THIS DIAGRAM ONLY IF YOU HAVE A CHARGE INDICATOR LIGHT.

Both diagrams accomplish the same task, using the brown #914 ALTERNATOR EXCITER wire to provide a switched power source and a resisted power source to the 2 wires of a CS-130D alternator pigtail/connector when a charge indicator light is **NOT** being used. Pick the method that easiest for you to understand.

CS-130D ALTERNATOR

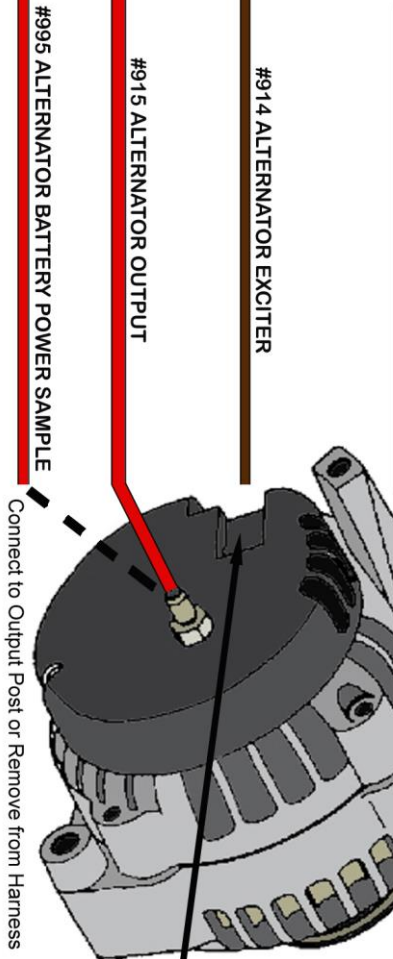

METHOD #1- USING 2 SPLICES

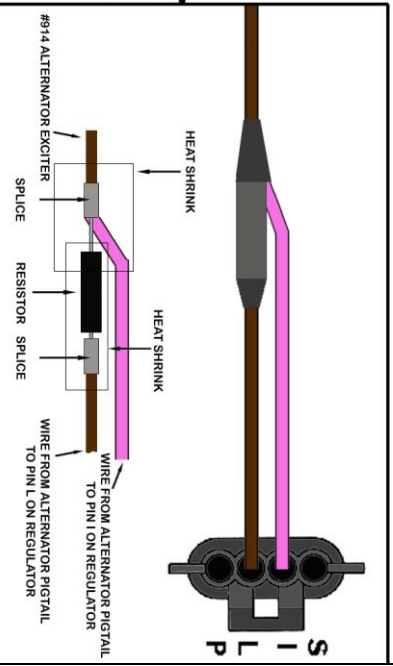

CS-130D ALTERNATOR

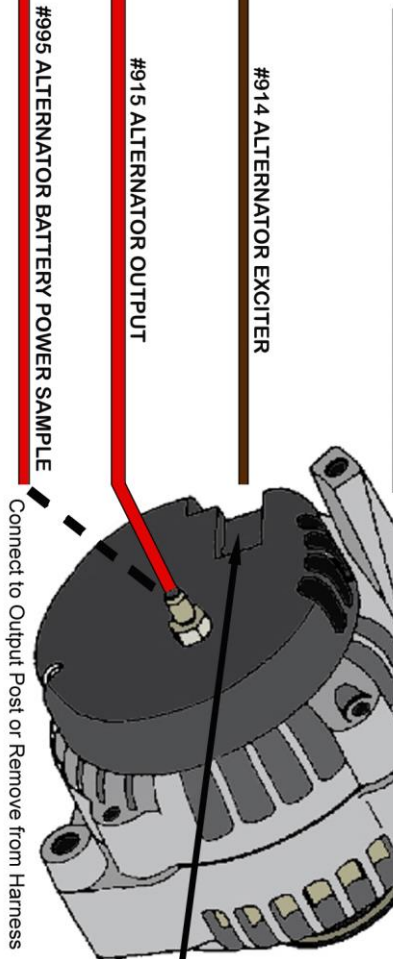

METHOD #2- USING 3 SPLICES

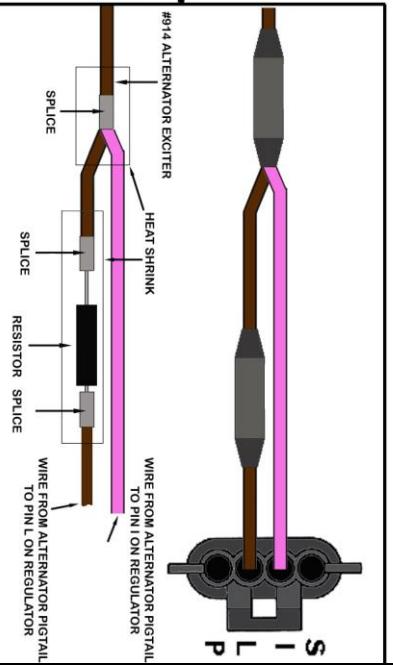

Externally Regulated Alternators

The very first years of production of the second generation Camaro had alternators with external regulators.

The two remaining wires, a 14 gauge red wire printed **#995 ALTERNATOR BATTERY POWER SAMPLE** and a 16 gauge brown wire labeled **#914 ALTERNATOR EXCITER**, will connect to the regulator.

- Route the two wires of the Painless harness to the connection point on the regulator and cut to length. Strip $\frac{1}{4}$ " of insulation from both wires.
- The four pin regulator connector and the two pin alternator connector from the harness removed from the vehicle prior to installation of the Painless will need to be used. Due to a lack of usage by most customers these connectors are not included with this Painless chassis harness. If you do not have these connectors they can be obtained online or at a local auto parts store, or you can use the loose piece insulated terminals in the parts kit to make connections.
- Connect the brown **#914** wire to the "4" terminal on the regulator.
- Connect the red **#995** to the "3" terminal on the regulator.

Two 14 gauge wires which run from the regulator to the alternator and a 14 gauge wire for a ground will need to be provided by the installer to finish the connections. These wires are not in the Painless harness.

- Connect the "2" terminal on the regulator to the "R" terminal on the alternator. This was a white wire from the factory.
- Connect the "F" terminal on the regulator to the "F" terminal on the alternator. This was a blue wire from the factory.
- The last connection will be connecting a wire from the "G" post on the alternator to a chassis ground source.

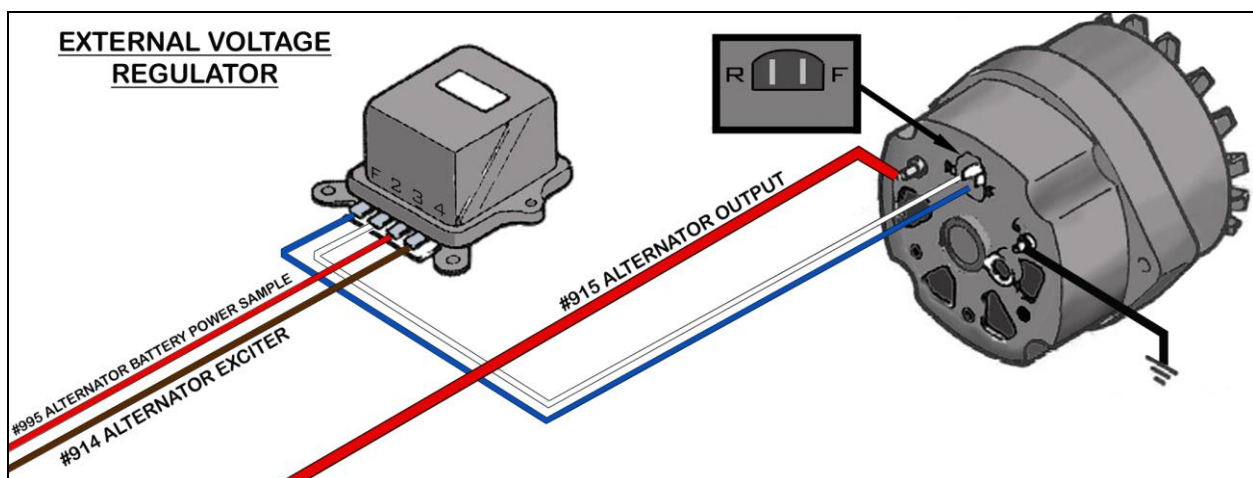

THIS CONCLUDES THE ALTERNATOR CONNECTION

“MIDI Fuse”

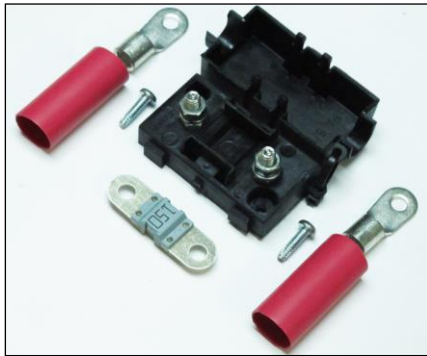

A large in line MIDI fuse has been included in the “Alternator” bag kit. This inline fuse will provide a fused link between the alternator and battery.

● Find a suitable location to mount the supplied fuse holder using the 2 screws provided. A drill with a 3/32” or .100 bit will be required in order to drill holes for the mounting screws. With the holes drilled, mount the fuse holder.

With the fuse holder now mounted locate the red 4 gauge charge wire with the label reading **#916 BATTERY SUPPLY TO FUSE BLOCK**. This wire will feed the harness battery power as well as feed the battery amperage from the alternator to keep the battery charged. See [Charge/Battery Power Schematic](#) on the next page.

● Route the large **#916** wire to one side of the fuse holder and cut the wire to length. **DO NOT DISCARD THE CUT OFF PORTION OF #916.**

The length of excess wire cut from the #916 wire will be used to connect the other side of the fuse to the “+” side of the vehicle’s battery or to the battery post on the starter solenoid. **DO NOT CONNECT THE #916 TO THE ACTUAL BATTERY AT THIS TIME.** If routed to the starter solenoid, this wire will NOT replace the battery cable needed by the starter from the positive side of the battery to the “BAT” or + post of the starter solenoid.

● Connection to both sides of the fuse holder will be made using the large ring terminals with the small #10 hole provided with the kit. You can use a pair of pliers if your crimpers will not accept this large gauge wire/terminal. The heat shrink supplied with this kit is intended to cover the crimped end of each of these two ring terminals. A schematic showing these connections can be found on the next page.

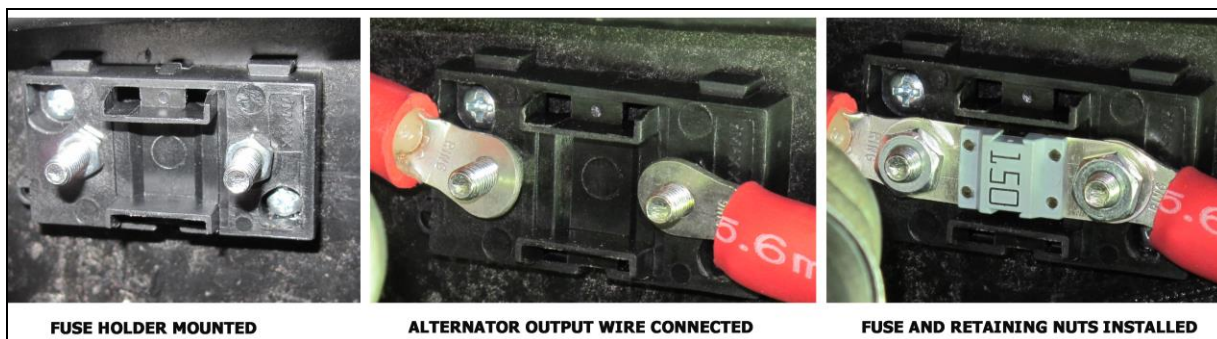

● Once the ring terminals are installed onto both studs of the fuse holder the fuse can be installed and everything can be tightened down with the 2 retaining nuts provided with the fuse holder. Once everything is tightened, the cover can be reinstalled. Depending on how your crimp flares the ring terminal, the cover may or may not need slight trimming in order to snap into place.

Remember to route the remaining end of #916 to either the battery lug or to the starter solenoid.

CHARGE/BATTERY POWER SCHEMATIC

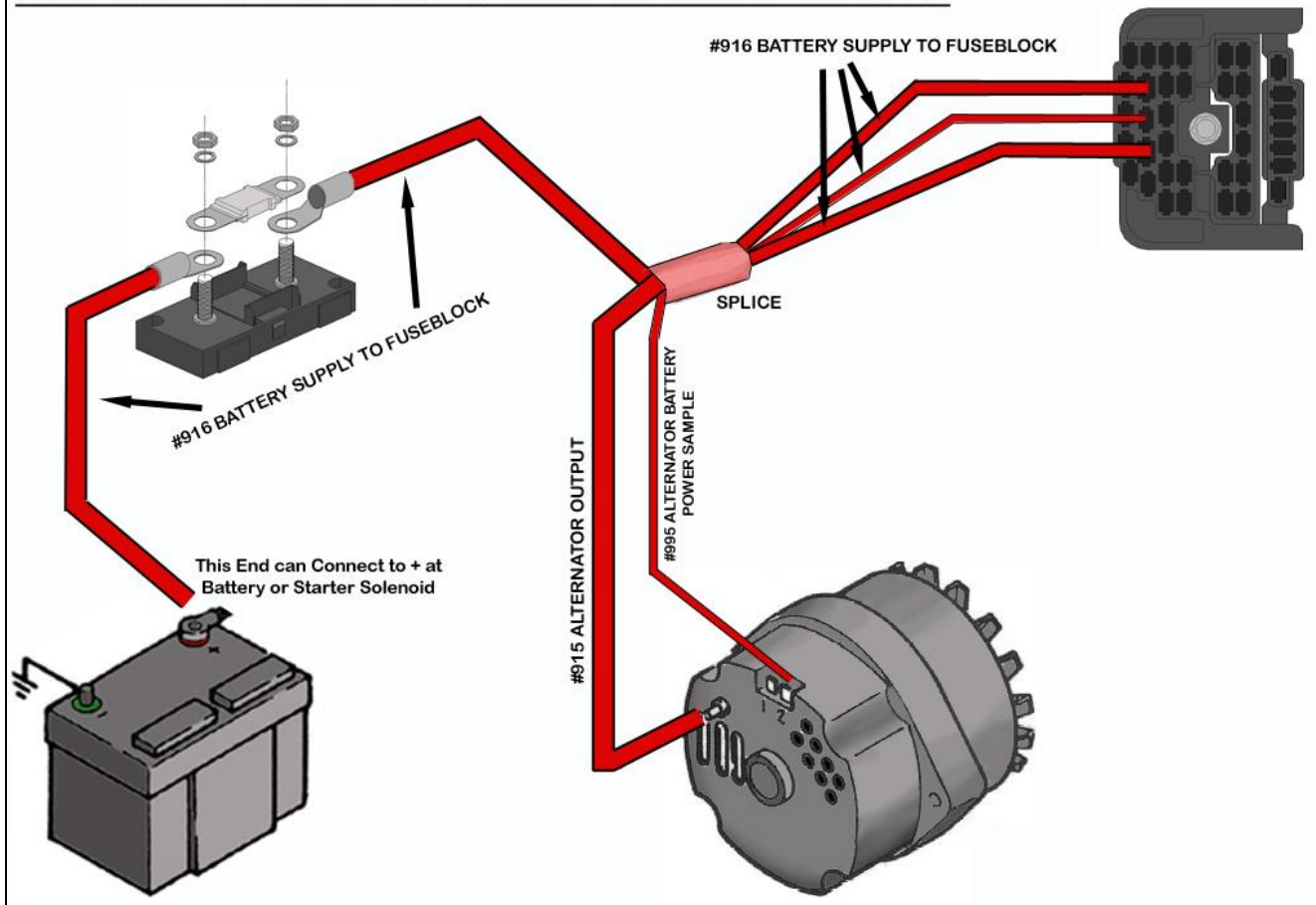

*The diagram above does not show the battery cable that connects from the + side of the battery to the + stud of the starter solenoid. This is not shown because it is not supplied with this Painless harness.

“Starter”

The connections to the starter will vary depending on your ignition system and your connection point on the remainder of the #916 wire coming from the MIDI fuse.

You will find 2 wires grouped together for starter connections. These wires are:

Purple: 12 gauge wire, printed **#919 STARTER SOLENOID "S" (START SIGNAL)**, this wire will supply the solenoid with a switched power source from the ignition switch. This power will activate the starter solenoid causing it to turn the engine over for start up. This wire will only have power when the ignition switch is in the *Start/Crank* position.

Yellow: 16 gauge yellow wire printed **#970 IGNITION BYPASS (COIL "+" TO STARTER "I")**. This wire will provide the coil a full 12v of power when the starter solenoid is engaged this wire will only have power when the key is in the *Start/Crank* position. The installs that utilize an internally resisted coil, an HEI distributor, or an aftermarket electronic ignition will not need to connect this wire; it may be removed from the harness.

- Route the purple **#919**, and the yellow **#970** (if used), to the starter solenoid and cut to length. If the remainder of **#916** from the MIDI fuse is being connected to the “BAT” or + post of the starter solenoid it may be routed at this point as well. Be sure to keep all wires away from the exhaust manifold or header.

- Locate heat shrinkable ring terminals from the parts kit that best fit the posts found on the starter solenoid and install onto the wires going to the starter solenoid. Be sure to apply heat to shrink the insulation to protect the crimp.
- The purple #919 wire will connect to the “START” or “S” post on the solenoid and the yellow #970 wire will connect to the “I” or “R” post of the solenoid, as seen in the schematic below.

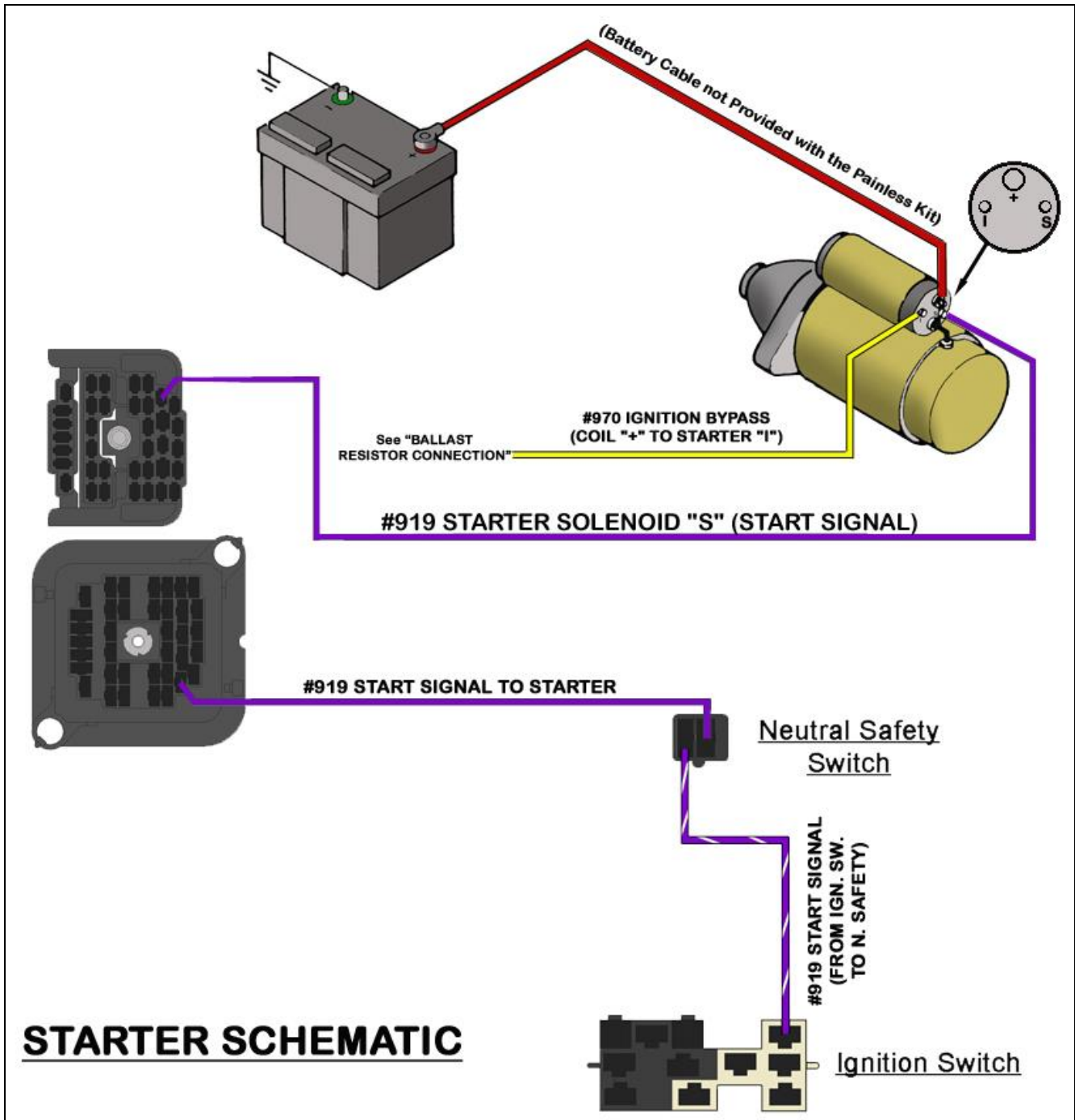

THIS CONCLUDES THE ENGINE HARNESS INSTALLATION



INTERIOR HARNESS

In order to properly route and connect the interior harness, it is recommended that the kick panels, A/C or blower switch panel, gauge cluster, radio, and glove box be removed. This will allow plenty of access to properly install this Painless harness.

The interior harness is broken down into breakouts throughout the dash. These breakouts correspond to the components they connect to as you move from left side of the vehicle or driver side to the right side, passenger side.

- Driver side kick panel area- contains wiring for the dimmer switch, emergency brake switch, key reminder buzzer, seat belt buzzer, heater-A/C switch power and panel light socket, brake switch, driver door jamb switch, a courtesy light, and a chassis ground connection
 - Steering column area- contains wiring for the ignition switch, turn signal switch, neutral safety switch, and reverse switch
 - Radio/Glove box/ Pass. side kick panel area- contains wiring for the radio, aftermarket gauge connector, gear indicator light (for floor mounted shifters), glove box light connector, a courtesy light, seat belt light socket, and passenger door jamb switch
 - Instrument cluster area- contains wiring for the cigarette lighter/power port, clock, instrument cluster/gauges, voltmeter, headlight switch, wiper switch and a panel light socket
- Begin by loosely routing the interior harness over the steering column and towards the passenger side of the vehicle just as the factory harness was routed. You will notice GM was not very generous on the amount of room given for harness routing. It may be a little difficult getting the harness over the column but with patience and passing a single connector through at a time it can be accomplished. Do not pull too hard on any of the wires.

The driver side kick panel area connections such as the driver side door jamb switch, interior ground, A/C panel, driver side courtesy light, and brake switch connections will **NOT** route over the column.

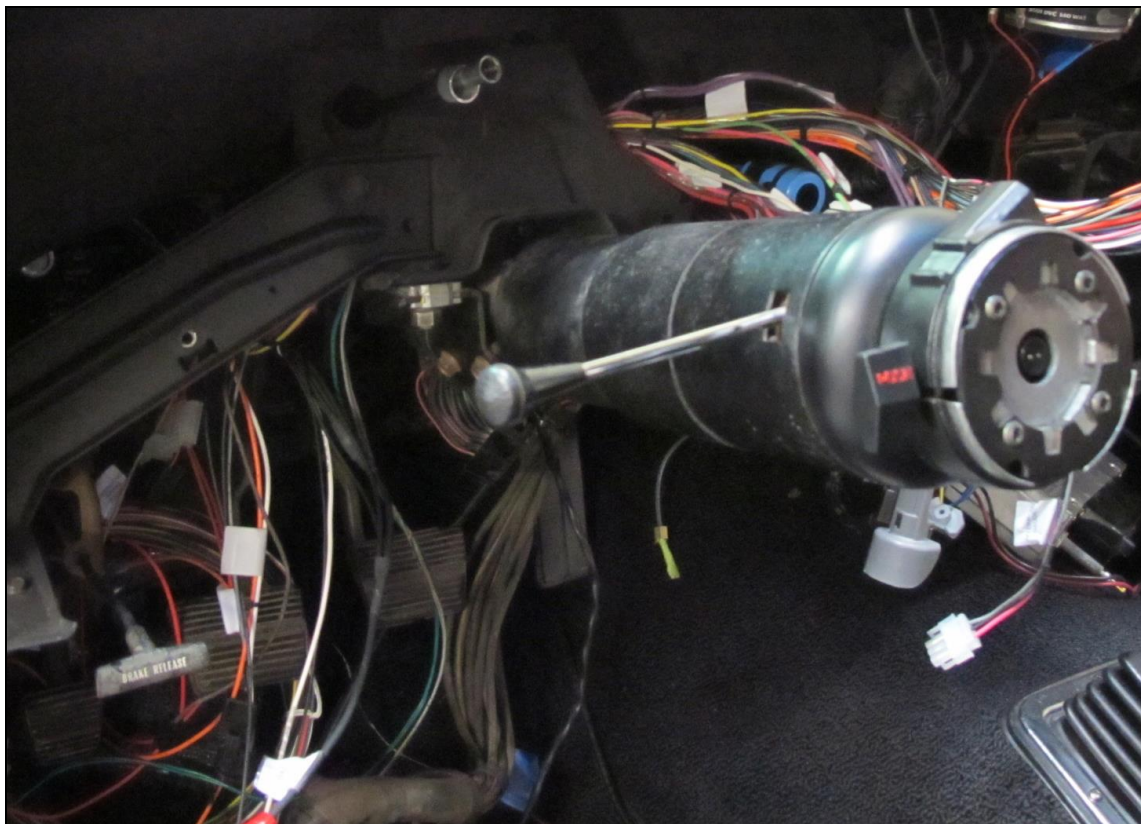

The following instructions will be in the order you come across connection points of the Painless harness as you move across the dash starting at the fuse block and working your way across the harness to the passenger side.

“Dimmer Switch”

The dimmer switch can be found mounted on the floorboard next to the driver side kick panel. The dimmer switch receives power from the headlight switch and based on the position of the switch will send power out the low beam or high beam wire.

Coming out of the bottom of the fuse block you will notice wires grouped together with a section label reading “DIMMER SWITCH”. These wires have a large black 3 pin connector preinstalled. The three wires that make up the connection to the dimmer switch can be seen in the [Front Lighting Schematic](#) on page 31, they are:



Light Blue- 14 gauge wire printed **#907 DIMMER SWITCH POWER**, this comes from the headlight switch and will have power whenever the headlight switch is in the *ON* position.

Tan- 14 gauge wire which is un-printed, this wire provides power through the bulkhead to the low beam filament of the headlights whenever the dimmer switch is in the low beam position and the headlight switch is in the headlights ON position.

Light Green- 14 gauge wire which is un-printed, this wire provides power through the bulkhead to the high beam filament of the headlights as well as power to the high beam indicator in the dash whenever the dimmer switch is in the low beam position and the headlight switch is in the headlights ON position.

- Remove the two screws holding the dimmer switch to the floor board if it is currently mounted.
- Plug the black three pin connector onto the dimmer switch, you will notice the connector will also go underneath the switch and will line up to the mounting holes.
- Using the original screws or two of the black 3/4" self tapping screws found in the parts kit, mount the dimmer switch to the floor board. There should be adequate length on the wires to enable you to re-use the existing holes in the floor.

"Emergency Brake Switch"

Of the wires coming out of the top of the fuse block the first connection you come to is a wire labeled "EMERGENCY BRAKE SWITCH". The emergency brake switch activates the brake indicator light on the dash.

Those that are using aftermarket gauges and do not have a brake indicator light, this wire will have no function and can be removed from the harness.

This connection will be one wire and will have a black single pin connector installed. The wire in this connector is:

Tan/White: 18 gauge wire, printed **#968 EMERGENCY BRAKE SWITCH**, this wire sends a ground source to the brake warning light in the dash, causing it to turn on when the emergency brake pedal is down. This wire is spliced into the low brake wire coming from the switch under the hood that was connected on page 21. This wire can be seen in the [Ignition Switch Schematic](#) on page 76.

Depending on the switch on the emergency brake, this single pin connector may need to be cut from the harness, and a bullet terminal with blue insulation from the parts kit may need to be crimped to the **#968** wire as shown in the photo.

- Route the tan/white **#968** wire to the emergency brake switch found next to the driver side kick panel on the side of the emergency brake pedal bracket and connect.

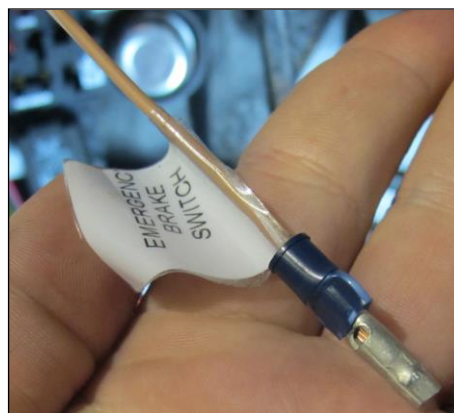
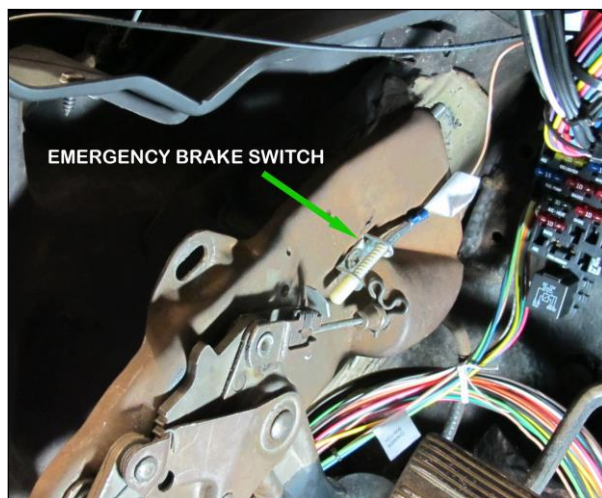

“Key Buzzer”

Locate the 2 pin black connector labeled “KEY BUZZER”. This connector will plug into an installer supplied key buzzer removed from the factory harness of 1972+ vehicles. These buzzers are no longer manufactured so finding a replacement may be difficult if you do not have one; however they may be found online using part GM part #6262663 OR #14001524. The latter has the seatbelt relay built into it, seen in the photo on the next page.

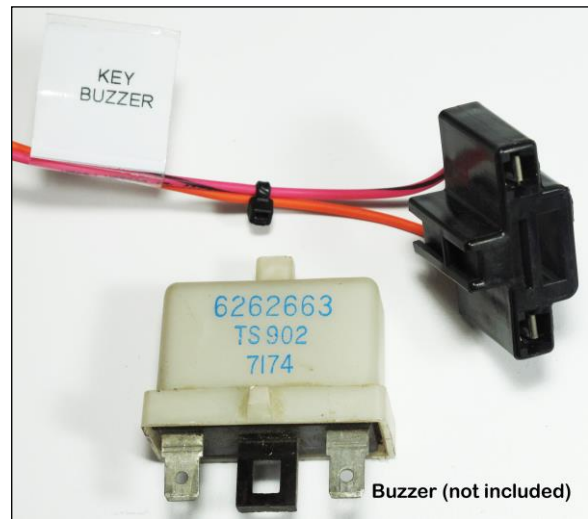

Those with 1970-71 models, either of these buzzers will replace the buzzer you had on the horn relay that was originally mounted in the engine compartment.

The two wires found in this connector will be:

Orange: 18 gauge wire printed **#903 KEY BUZZER POWER**, which receives battery power through the cigarette lighter fuse, this wire can be seen in the [Accessory Schematic](#) on page 82

Pink/Black: 18 gauge wire printed **#999 KEY BUZZER GROUND**, which get its ground source through the turn signal switch, this wire can be seen in the [Turn Signal Schematic](#) on page 78.

The buzzer has constant battery power which means it is ground activated. This is done through the turn signal switch in the steering column. The pink/black wire coming from the turn signal switch will be grounded anytime a key is in the ignition in the *OFF* position and the drive side door is open. The driver side door jamb switch has a black wire going to the turn signal switch to provide the ground source to the column.

If you do not have a key buzzer, zip tie this connector to the harness and skip to the next connection.

- Using fine grit sandpaper or a cleaning agent on a cotton swab, clean the contacts of the key buzzer/buzzer connector to remove any grease/dirt buildup if you are re-using an old key buzzer.
- You can test the working condition of your buzzer before installation by using a piece of wire on each terminal of the key buzzer and touching one wire to the + battery post and the other wire to the – battery post. This buzzer is not polarity specific and either terminal can go to power or ground.
- Plug the buzzer into the connector on the Painless harness; it will only plug in one way. A 1972-1978 buzzer is shown on the previous page, a 1979-1981 is shown below.

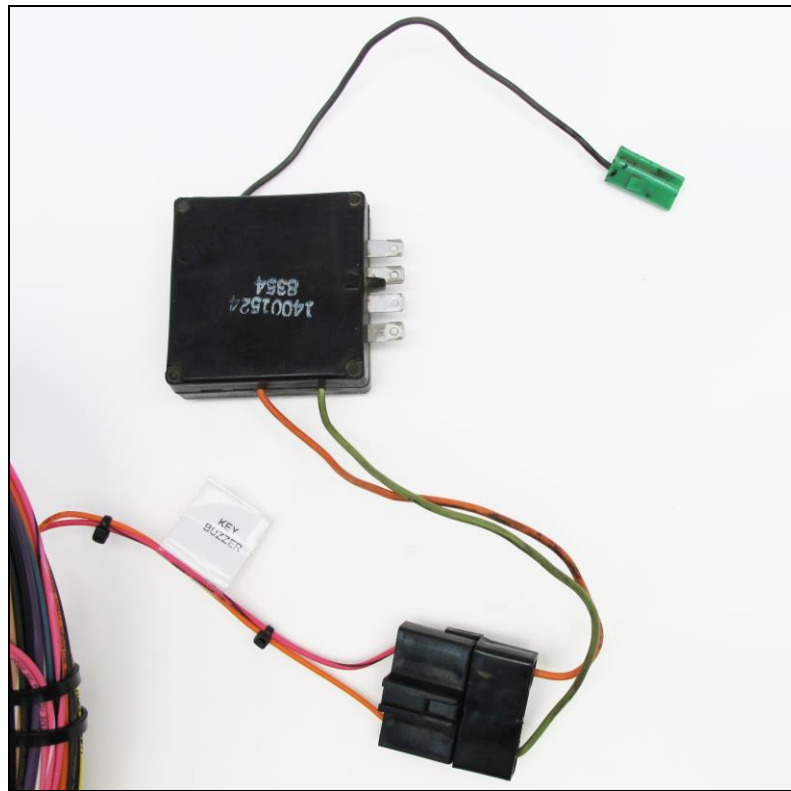

Notice the in the picture above, there is a gray wire coming from the 1979-1981 key buzzer/seatbelt buzzer-relay that goes into a green connector. This is for a headlight reminder buzzer. If the headlights were on, and the driver side door was opened, the buzzer would go off. This originally plugged into the fuse block cavity that had power to the instrument lights. This connection isn't supported in the Painless harness however it will be easy to connect.

- Cut the green connector and terminal from this gray wire.
- Using a splice from the parts kit, connect this wire to any park light/tail light or gauge light power wire coming from the headlight switch. There is also a gauge light power wire at the aftermarket gauge connector that may not be used in your particular install that can be used for this purpose as well.

“Seat Belt Buzzer-Relay”

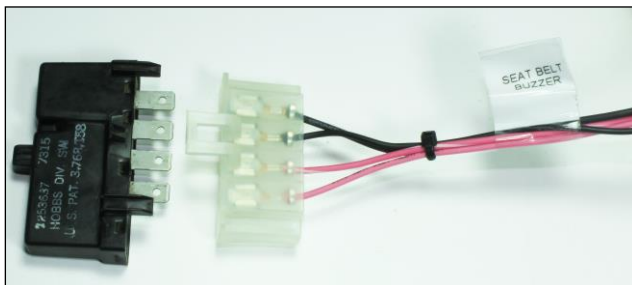

The following connection will only pertain to those with 1973-1981 dashes. More specifically, those with the seat belt indicator on the dash. If you do not have this light on your dash or a working seatbelt buzzer-relay, zip tie this connector to the harness and skip to the next connection.

The seat belt buzzer-relay has an internal timer that controls the seat belt warning light that will illuminate every time the ignition switch is in the ON/RUN position. This light will come on for 4-8 seconds then shut off, regardless if the seat belt is plugged in or not. The buzzer found in this relay will also come on for 4-8 seconds when the ignition switch is in the ON/RUN position, however if you plug the driver side seat belt in before turning the ignition on, this buzzer will not sound.

The wires for proper seat belt buzzer-relay connection will come with a pre-installed 4 pin clear connector. They can be identified by the section label reading “SEAT BELT BUZZER”, these wires are:

Pink: 18 gauge wire, **printed #935 SEAT BELT RELAY POWER**, this wire will provide power to the buzzer-relay anytime the ignition switch is in the ON/RUN position. This wire comes from the 10 amp GAUGES fuse. See the [Gauge Power Schematic](#) on page 95

Pink/White: 18 gauge wire, printed **#942 SEAT BELT LIGHT POWER/ACTIVATION**, this wire is the power from the seat belt relay to the seat belt light. This wire will have power for 4-8 seconds after the ignition is turned to the ON/RUN position. After this 4-8 second the relay will open and this wire will no longer have power.

Black: 18 gauge wire, printed **#993 SEAT BELT GROUND SIGNAL**, this wire supplies the buzzer with a ground signal from the driver side seat belt whenever the seat belt is connected.

Black: 18 gauge wire, there is no print on this wire, this wire provides a ground source to the buzzer-relay and comes from a splice that is tied to the interior ground wire. This ground along with the other interior ground wires and splices, can be seen in the [Ground Schematic](#) on page 15.

- If you are re-using an old key buzzer-relay, use fine grit sandpaper or a cleaning agent on a cotton swab to clean the contacts of the buzzer-relay to remove any grease/dirt buildup.
- Plug the buzzer-relay into the connector on the Painless harness; it will only plug in one way.

“Power Window & Power Lock”

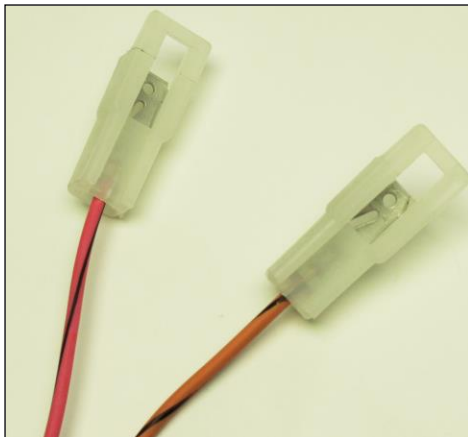

There are two wires provided in the Painless harness for connection to power windows and power locks. These two wires will provide battery power for power locks, and ignition switched power, for power windows. These wires can be used with a factory power window/power lock harness, Painless part #30715, or can be connected to aftermarket systems.

If your vehicle is not equipped with these options or only has one, the unused power window/power lock circuit(s) can be used to provide power to other components. You will need to replace the fuse at the fuse block of which ever circuit you are using to match the amperage rating of the component you are connecting it to. **These wires are not to exceed 30 amps.**

The power lock wire will be indicated by a section label reading “Power Lock”. This will be a single pin white connector, shown in the photo above. The wire in the connector will be:

Orange/Black: 14 gauge wire printed **#910 POWER LOCK POWER SOURCE (BATTERY)**. This wire comes from the 30 amp Power Lock fuse on the fuse block and is a constant battery power source, as indicated by “(Battery)” being printed on the wire. This wire will have a single pin white connector pre-installed and can be seen in the [Accessory Schematic](#) on page 82.

The power window wire will be indicated by a section label reading “Power window”. This will be a single pin white connector, shown in the photo above. The wire in the connector will be:

Pink/Black: 14 gauge wire printed **#911 POWER WINDOW POWER SOURCE (IGN)**. This wire comes from the 30 amp Power Window fuse on the fuse block and is an ignition switched power source, as indicated by “(IGN)” being printed on the wire. This wire can be seen in the [Accessory Schematic](#) on page 80.



Two single pin connectors and two terminals, seen in the photo to the left, have been provided to allow connection to the connectors found on the power lock/power window wires of the Painless harness. These connectors will allow you to make a factory style connection to your factory power lock/power window harness, to aftermarket power lock/power window harnesses, or to a component you may be powering with one of these circuits.

For those reusing the factory power lock/power window harness, the following set of instructions will be used to slightly modify the original harness to work with the Painless harness. For those not connecting a factory harness, proceed to the next connection, the Driver Side Door Jamb Switch.

- Begin by locating the two connectors on the factory power lock/power window harness that connected to the accessory ports at the fuse block. This will be a pink/black wire with a single pin clear connector and an orange/black wire with a red single pin connector. The pink/black provides power to the window switch. The orange/black provides power to the lock actuators in the doors. Both of these connectors can be seen in the photo to the right.

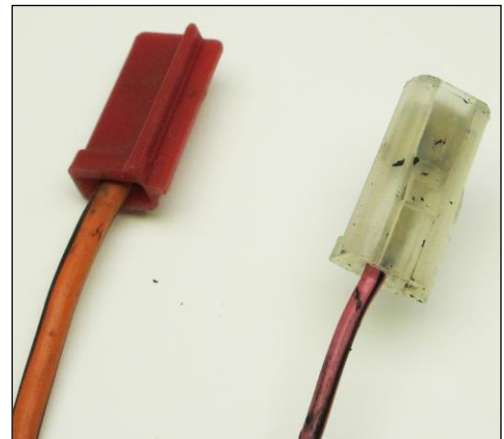

These connectors use the same terminal that is provided in the kit that mates to the power lock/power window connectors found on the Painless harness. A simple connector change is all that is needed in order to re-use the factory power lock/ power window harness with the Painless harness.

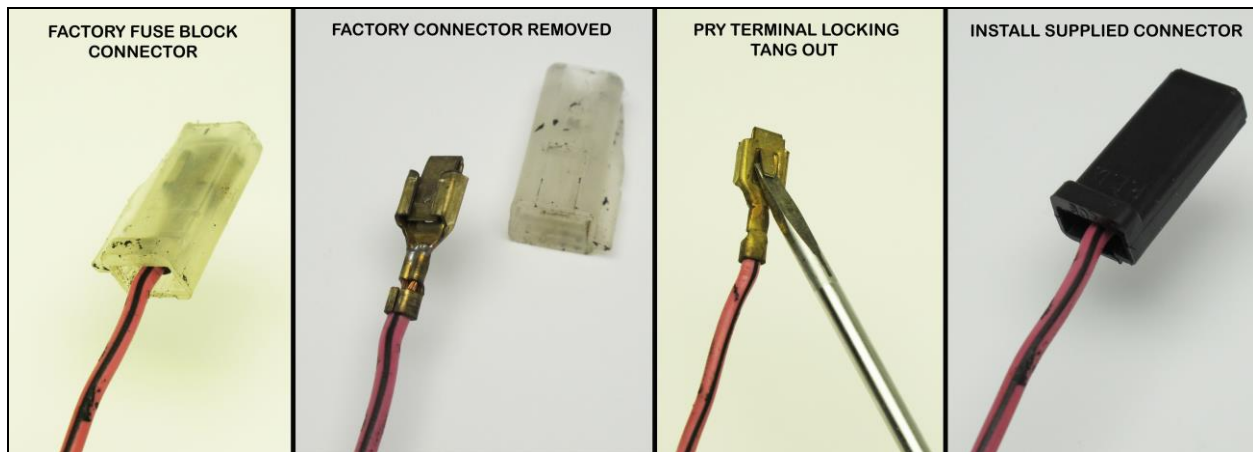

- Using the terminal removal procedure, found in the washer pump section on page 27 of the Engine Harness manual, remove the two fuse block connectors on the factory harness. Remember to pry the locking tang of the terminal back out once the connector is removed. The factory connectors can also be cut from the original harness and the new terminals that are provided with the Painless kit can be installed.
- Install one of the single pin connectors on each of the factory wires and connect them to the Painless harness. The factory pink/black wire will connect to the power window, pink/black #911, wire on the Painless harness. The factory orange/black wire will connect to the power lock, orange/black #910, wire on the Painless harness.

Painless part # 30715 was created to work with the components used in factory 2nd gen Camaro power window/power lock system. #30715 will plug directly into these two connectors found on this chassis harness.

“Driver Side Door Jamb Switch”

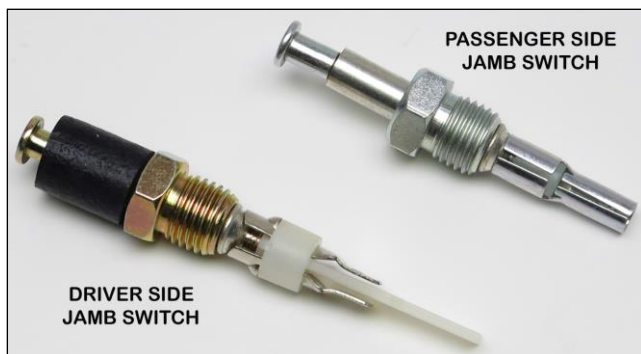

Locate the two door jamb switches provided with the Painless harness. They are included with the kit because the terminals on the switch tend to break during the factory harness removal. These switches are factory replacement switches and will work just as the factory switches did. These switches will provide the ground source activation required to turn the dome and courtesy lights on.

When the door is opened, the plunger on the switch extends out as it is no longer being pushed in by the door. When the plunger extends, the contact point on the back of the switch makes contact with the body of the switch, which is grounded through the mounting into the metal door jamb. This grounding gives the wire(s) attached to the switch a ground source which will then cause the interior lights to come on and if a key is in the ignition, the key buzzer will activate.

- Remove the original door switches, in both driver and passenger side door jamps. This will require a deep 7/16” socket.

- Install the new switches into the door jambs using the same 7/16" socket. Notice there are two different switches, one with two posts and one with a single "barrel" style connection. The two terminal switch is intended for the driver side door jamb. The additional terminal on this switch is for the key buzzer.
- If the holes are striped or contaminated with rust buildup, cleaning the hole with a 3/8" x 24 tap will allow the switches to be installed.



Locate the two wires with the section label reading "DRVR. DOOR JAMB SWITCH". Both of these wires have a small pink colored insulated terminal pre-installed on them, they are:

White: 18 gauge wire, printed "**#961 DRIVER DOOR JAMB SWITCH**", this wire is tied to the ground side of the included courtesy lights as well as the white wire in the Tail Section of the harness intended to be connected to the ground side of the dome light. This wire will be grounded anytime either door is opened or when the headlight switch knob is rotated to the "Dome Light On" position. This wire can be seen in the [Headlight Switch Schematic](#) on page 97 and the [Dome/Courtesy Light Schematic](#) on page 71.

Black: 18 gauge wire, printed "**#966 KEY BUZZER SIGNAL**", this wire sends a ground signal to the turn signal switch. If a key is present in the ignition switch, this ground signal passes through the turn signal switch, to the key buzzer. This wire will only be grounded when the door is open. This wire can be seen in the [Turn Signal Schematic](#) on page 78.

- Route the white #961 and black #966 wires to the driver side door jamb switch and connect to each of the two terminals. It does not matter which terminal either wire is connected to.

You may have to unscrew the door jamb switch ¼ turn in order to make the second connection to the switch. Once connected, retighten the switch in the jamb.

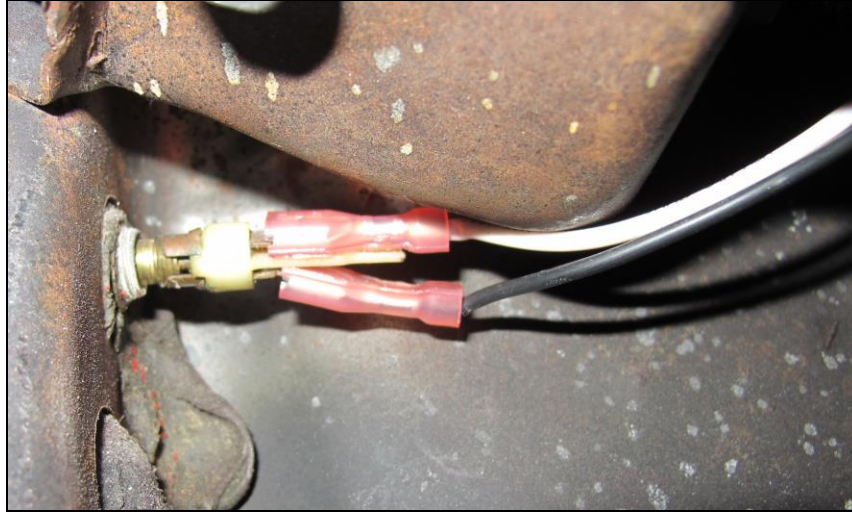

“Brake Switch”



Locate the brake switch at the top of the brake pedal. This will be a small cylindrical switch that has a plunger, like the door switch, that opens and closes the switch based on brake pedal position.

This switch is what is called normally open, meaning the two terminals are not connected together when the switch is in its normal position. As soon as the brake is applied, it closes the switch to internally connect the two posts of the switch.

This switch requires two wires, a battery power wire and an output wire to the brake lights. The pre-installed connector, shown on the previous page, will connect to the factory switch. If your switch differs from the connector provided, the connector can be cut off the harness and insulated terminals from the parts kit, like those shown to the right, can be used to make individual wire connections to the brake switch.



The two wires of the Painless kit that make up the brake switch connection are:

Orange: 16 gauge wire, printed #917 BRAKE SWITCH POWER INPUT, which provides power from the 15 amp STOP fuse. This wire will have power at all times.

White: 16 gauge wire, that is not printed. This wire supplies power from the brake switch to the brake lights. This wire goes into a splice with 2 other wires. This splice can be seen in the [Turn Signal Schematic](#) on page 78.

- Route the brake switch wires to the brake switch and connect using the pre-installed connector or loose piece insulated terminals provided in the parts kit. Be sure to route the wires away from the moving parts of the brake pedal and/or clutch pedal.

If your brake switch has four connection pins, two pins will have contact or will be closed when the brakes are not applied and two will be separate or open when the brakes are not applied. You will need the 2 posts that are separate or normally open. The normally closed pins are for cars equipped with cruise control or an automatic transmission with a lockup torque convertor, this harness does not provide wires these components.

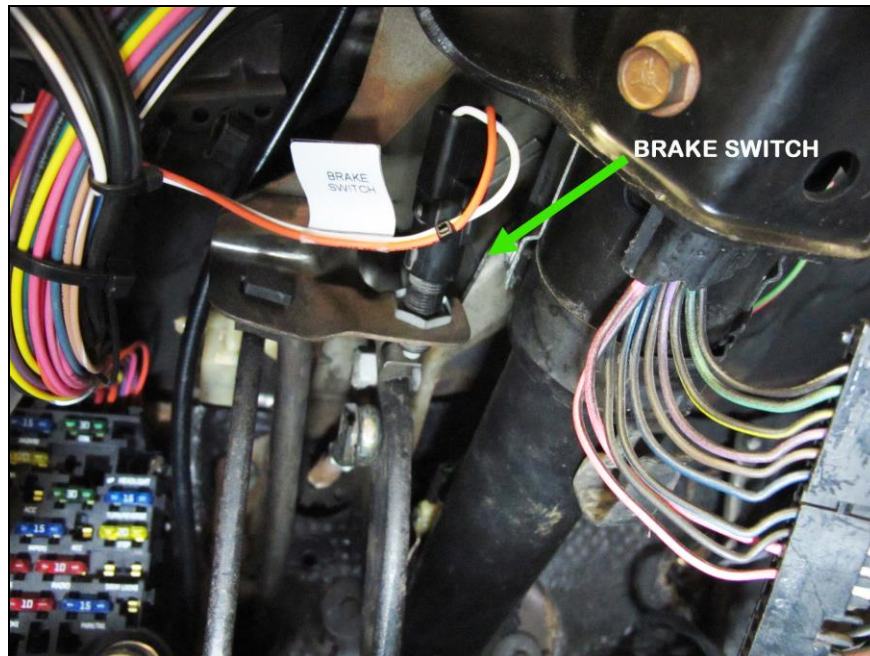

“Blower Switch Power”



The next connection is the power supply from the Painless harness to the blower switch.

The blower switch power wire has a section label reading “A/C & BLOWER SWITCH POWER”. This will have a single pin black connector pre-installed, as seen in the photo to the right. The wire in the connector will be:

Brown: 14 gauge wire, printed **#904 HEATER SWITCH POWER INPUT**. This connection will be a 30 amp, ignition switch power source, from the A/C-HEAT fuse on the fuse block. This wire can be seen in the [Accessory Schematic](#) on page 80 and also in the [Heater Only Schematic](#) on page 67.



This connection will be made to the inline connector on the supplied blower switch harness or to the inline power connector on your factory A/C harness. Those with factory A/C equipped vehicles will re-use your original harness.

The supplied blower switch harness, will only work on vehicles that have heater only systems. If you have a heater only system, locate the supplied blower switch sub harness, seen in the photo above, and remove it from the bag.



Installs using an aftermarket A/C, this brown **#904** wire will provide a switched ignition power source your system may need. A connector and flag style terminal, seen in the photo, have been provided to allow you to make a factory style connection to your aftermarket system by installing them on your aftermarket A/C harness.

Those using factory systems:

- Locate the inline connector on the factory A/C harness or on the blower motor harness supplied with this kit. It will be a single pin connector with a brown wire. The connector will look like the one pictured above, also seen in the blower switch sub harness above.
- Plug the connector on the brown **#904** from the Painless harness into the inline connector of the A/C harness or the blower motor sub harness. This will be the only connection made between the chassis harness and the A/C harness or the blower motor harness.
- Connect the remaining connectors of your A/C harness or the blower switch sub harness, to the A/C panel or blower switch. The photo to the right shows the blower switch connector found on the heater only Blower switch sub harness included with the Painless kit.
- The remainder of the A/C harness or blower switch sub harness will route to the passenger side of the vehicle with the remainder of the chassis harness.

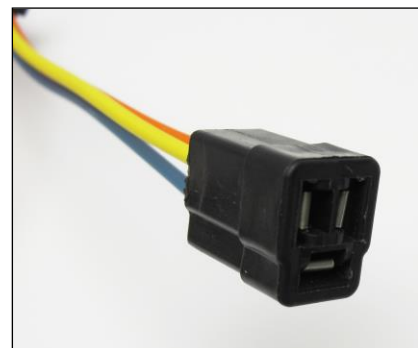

Vehicles with heater only systems will connect the 3 pin connector found on the sub harness, seen to the right, to the blower motor resistor. The remaining 14 gauge orange wire, printed **#967 BLOWER MOTOR POWER**, of the sub harness will route to the blower motor through the 1 ¼" hole found on the fire wall behind the resistor.

Blower Motor

The blower motor is located on the firewall behind the passenger side inner fender. In order to access the blower motor, the passenger side inner fender will need to be loosened or removed. This will involve removing the ½" bolts around the fender lip as well as inside the inner fender.

Locate the 12 gauge orange wire printed **#967 BLOWER MOTOR POWER**. This wire will have a single pin black connector pre-installed. This wire will provide power to the blower motor from the blower switch. A schematic showing this wire can be seen on the next page.

- Route the **#967** wire towards the blower motor.
- Connect the **#967** wire to the top terminal on the blower motor, this will be the power terminal. The bottom terminal will connect to ground. This ground wire is not included with the Painless harness because it was a dedicated ground and not part of the factory chassis harness.

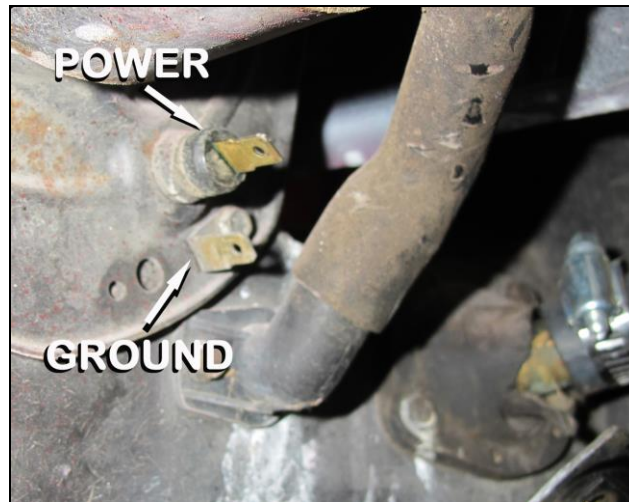

HEATER ONLY SCHEMATIC

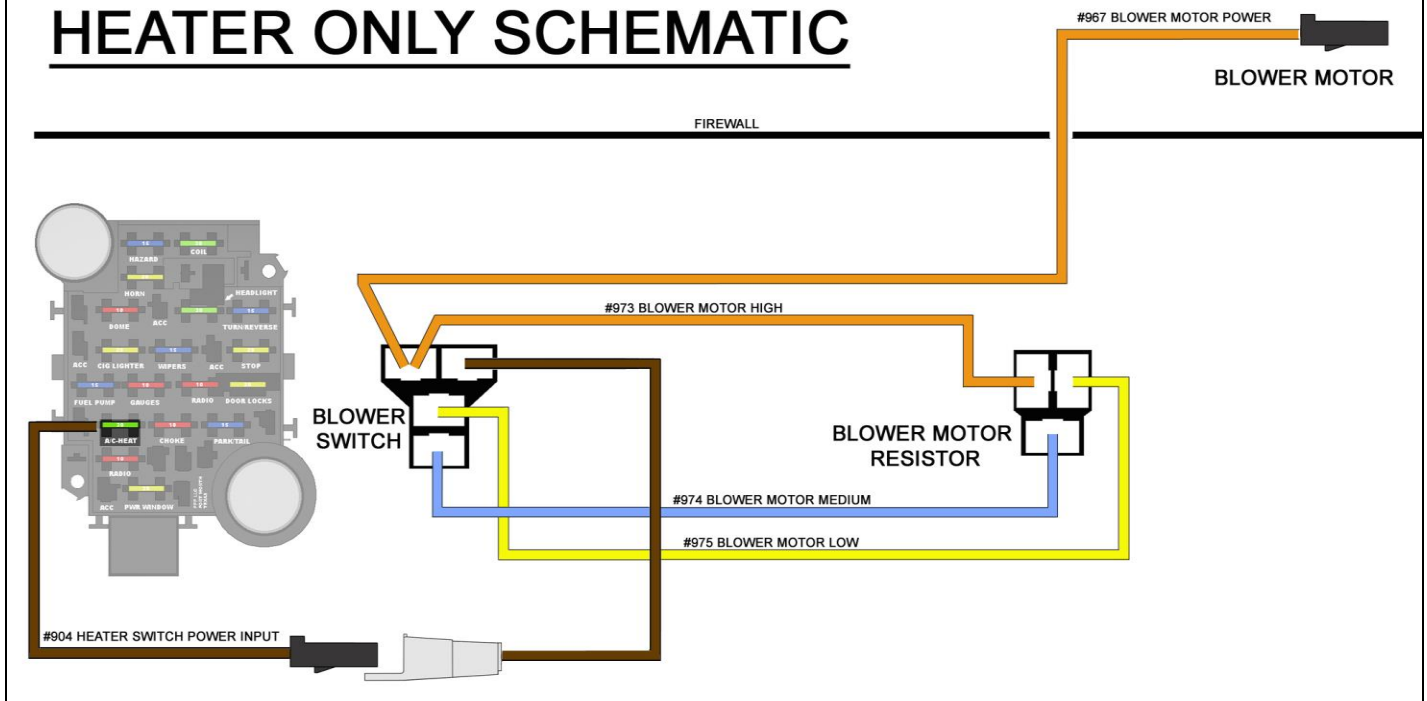

“Panel Light”

The next connection on the new Painless chassis harness is the panel light. This connection will provide a light source to the A/C or blower switch panel. This light socket receives power from the headlight switch whenever the headlight switch is in the Park Lights ON and in the Headlights ON positions.

The panel light connector has a section label reading PANEL LIGHT, as seen in the photo. This will be a two pin black socket pre-installed, the wires in the socket will be:



Gray: 18 gauge wire, printed **#930 PANEL LIGHT POWER**. This wire comes from a splice that distributes power from the headlight switch. This splice can be seen in the [Headlight Switch Schematic](#) on page 97.

Black: 18 gauge wire, this wire is not printed. This wire provides a ground source for the light and comes from a splice that is tied to the interior ground wire. This panel light ground along with the other interior ground wires and splices, can be seen in the [Ground Schematic](#) on page 15.

- Insert the socket, with the bulb installed, into the panel lamp hole on the back of the A/C or blower switch panel.

“Interior Ground”



The interior ground wire is the next connection you will come to. It will help provide a clean ground source to interior components such as the gauge cluster, radio, wiper switch, headlight switch, etc. This connection will also supply another good ground source to the integrated ground circuit that has been incorporated into this Painless kit.

This ground wire will have a section label reading “Ground” and will have a ring terminal pre-installed. The wire going to this ring terminal will be:

Black: 10 gauge wire, this wire will not have any print. It is part of the **#969** circuit as it is spliced into the ground circuit. This ground wire, along with all the other wires it is spliced to can be seen in the [Ground Schematic](#) on page 15.

- Locate the ground wire on the Painless harness.
- Route this ground wire to a clean ground source, such as one of the bolts on the brace above the steering column, see photo below. Ring terminals and self tapping screws have been provided in the parts kit to allow you to easily make this connection if this brace location does not work for you.



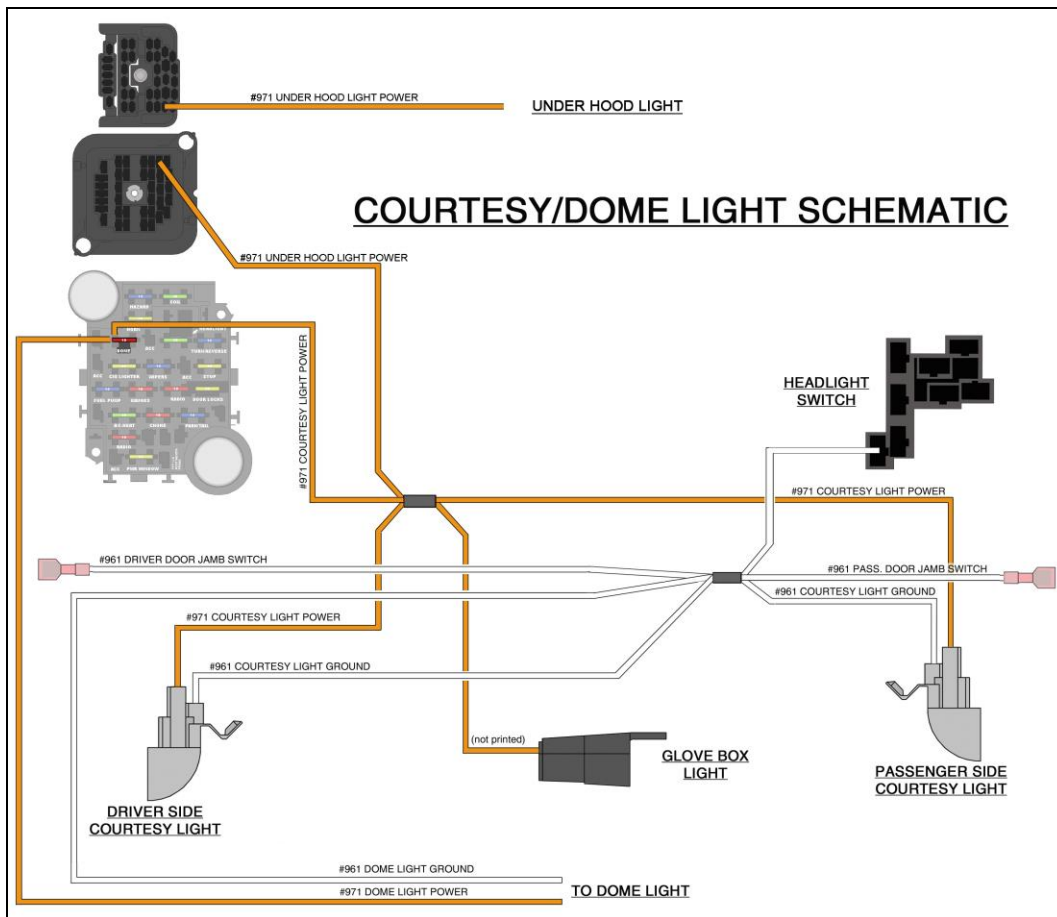

“Courtesy Light”

The courtesy light is the last connection of the driver side kick panel area connections. This connection will allow the under dash/pedals of the driver side of the vehicle to be illuminated any time a door is open or when the headlight switch is activating the dome light. Your vehicle may or may not have had them from the factory; that will not affect these working properly as they have been pre-wired into the Painless harness.



This connection will have a section label reading “COURTESY LIGHT”. It will be a large gray colored lamps socket with two wires pre-wired to it, these wire are:

Orange: 18 gauge, printed **#971 COURTESY LIGHT POWER**. This power wire is spliced to the wires going to the passenger side courtesy light, the glove box light, and to a wire that comes from the 10 amp DOME fuse on the fuse block; this fuse has battery power and is hot at all times. This wire can be seen in the [Courtesy/Dome Light Schematic](#) above.

White: 18 gauge, printed **#961 COURTESY LIGHT GROUND**. This wire is the ground wire that activates the courtesy light. When this wire is grounded it completes the voltage path causing the light to illuminate. This ground will come from either the door jamb switch or the headlight switch. This wire is splices to wires going to these components and can be seen in the [Courtesy/Dome Light Schematic](#) above.

This light socket uses both a 63 and 67 series bulb; a 67 series bulb has been pre-installed into the socket.

- Route the socket to a suitable mounting location under the dash. The light socket has a small hole in a mounting tab to allow mounting. Self tapping screws have been provided as a mounting solution. Small zip ties, provide with this kit, may also come in handy if a suitable location for the light socket cannot accommodate mounting with a screw.

“Neutral Safety/ Clutch switch”

This switch sits inline of the wire coming from the “Start” terminal of the ignition switch to the “S” terminals of the starter solenoid.

This switch is a 2 pin, normally open, switch that has power coming into one side from the start position of the ignition switch and power going out the other side to the starter solenoid “S” terminal.



This switch is a safety device that will prevent the vehicle from being started while in gear and causing an unfortunate accident. The purpose of this switch is to only allow the engine to be started when the vehicle is in park or neutral (automatic transmissions) or if the clutch is applied (manual transmissions). When the transmission is put into park/neutral or the clutch is applied, contact is made between these two pins, closing the switch. This allows power to flow from one pin to another, transferring power through the switch to the starter solenoid.

The neutral safety/clutch switch connection will have a section label reading “NEUTRAL SAFETY”. This will be a black 2 pin connector with 2 wires going to it, as seen above. These wires are:

Purple: 14 gauge wire, printed **#919 START SIGNAL (FROM IGN.SW. TO N.SAFETY)**, this wire comes from the Ignition switch. This wire is a switched ignition power wire. It will only have power when the ignition switch is in the START position. This wire can be seen in the [Starter Schematic](#) on page 5, and on the [Ignition Switch Schematic](#) on page 76 of this manual.

Purple/White: 14 gauge wire, printed, **#919 START SIGNAL TO STARTER**, this wire provides power from the neutral safety to the Starter solenoid. This wire will have power when the ignition switch is in the START position AND the transmission is in park or neutral (automatic) or the clutch is applied (manual). This wire can be seen in the [Starter Schematic](#) on page 54.

- Locate the Neutral Safety switch at the base of the steering column, if you have an automatic transmission. If you have a manual, the clutch switch will be located at the top of the clutch pedal much like the brake switch on the brake pedal. See the photos on the next page
- Plug the neutral safety connector onto the two pins of the neutral safety/clutch switch.

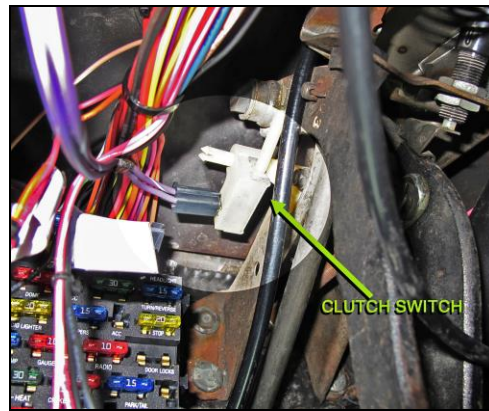
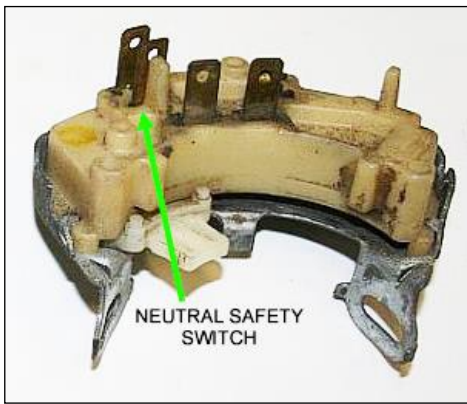

Those with an automatic transmission and an aftermarket floor mounted shifter, in most cases, this switch will be found on the base of the shifter. This connection will need to be lengthened and routed to the shifter, as seen in the photo to the right. Small insulated terminals have been provided in the parts kit to accommodate aftermarket shifter reverse switches.

If you do not have a neutral safety/clutch switch, and do not plan on getting one, cut the connector from these two wires and connect the purple #919 and the purple/white #919 together.



Painless does not recommend operating your vehicle without a neutral safety/clutch switch.

“Reverse Switch”

The reverse switch connection will provide the backup lights the power they need to illuminate. This switch is a 2 pin normally open switch that has power coming into one side and power going out the other side to the backup lights. When the shifter is put into the reverse position, contact is made between these two pins, closing the switch. This allows power to flow from one pin to another, transferring power through the switch out to the backup lamps.

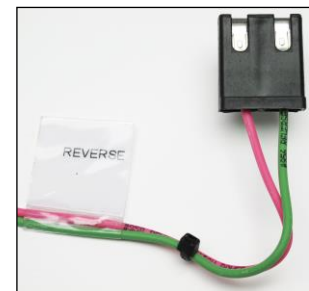

The reverse switch connection will have a section label reading “Reverse”. This will be a black two pin connector with two wires going to it, as seen above. These wires are:

Pink: 16 gauge wire, printed #958 REVERSE SWITCH POWER INPUT, this wire comes from the 15 amp TURN/REVERSE fuse on the fuse block. This wire is a switched ignition power wire meaning it will only have power when the ignition switch is in the ON/RUN position.

Light Green: 16 gauge wire, printed #956 REVERSE LIGHT POWER, this wire provides power from the reverse switch to the backup lights in the Tail Section of the Painless harness.

- Locate the reverse switch at the base of the steering column.
- Plug the reverse switch connector onto the 2 pins of the reverse switch.

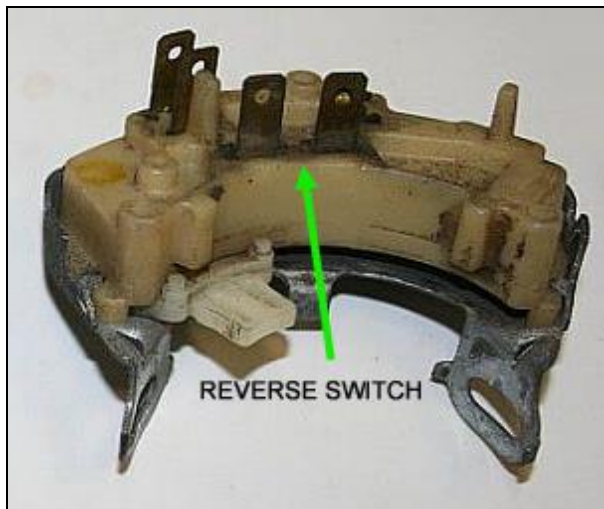

If you are using an aftermarket floor mounted shifter, this switch may be found on the base of the shifter. This connection will need to be lengthened and routed to the shifter. Small insulated terminals have been provided in the parts kit to accommodate aftermarket shifter reverse switches.

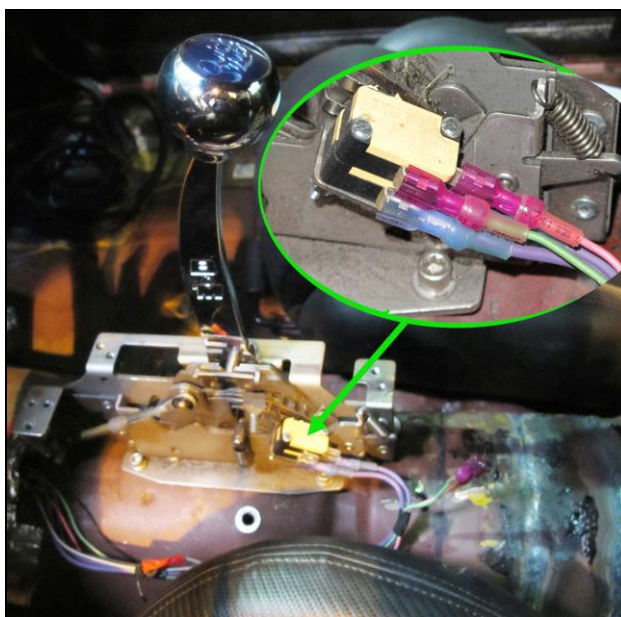

“Ignition Switch”

The ignition switch is one of the most important connections of a wire harness. Its function will control power to the switched ignition fuses on the fuse block as well as sending a start signal to the starter to allow engine operation.

The ignition switch connection consists of two connectors with a section label reading “IGNITION SWITCH”. These two connectors will be black and clear. All wires going to the ignition switch connectors can be seen in the [Ignition Switch Schematic](#) on page 76.

The black connector is a four pin connector with the following wires:

Red: 12 gauge wire, printed **#934 IGNITION SWITCH POWER**, this wire comes from a buss bar on the fuse block and feeds battery power to the ignition switch. This wire will have power at all times.

Orange: 12 gauge wire, printed **#933 SWITCHED (IGN) POWER TO FUSE BLOCK**, this wire provides the switched power source to the fuse block. This wire powers all of the switched power circuits to the harness, with the exception of the A/C-HEAT, RADIO, and POWER WINDOW fuses. This wire will only have power when the ignition switch is in the ON/RUN position. This wire is in the same pin location on the black ignition switch connector as the brown/white wire.

Brown/White: 16 gauge wire, printed **#914 ALTERNATOR EXCITER**, this wire provides the alternator with a switched power source needed to excite the field of the alternator allowing it to begin to charge. This wire is in the same pin location on the black ignition switch connector as the orange wire. This wire goes to a connector found in the instrument cluster section on this harness. **Pay attention to the details of this wire when you get to the "Instrument Cluster" section of this manual, page 83, or your alternator will not charge correctly.**

Tan/White: 18 gauge wire, this wire is not printed but it is part of the **#968** Low brake signal circuit. This will provide a ground source to the low brake light on the instrument cluster when the key in the start position. This will indicate that the bulb is operable and will indicate when a low brake fluid pressure condition occurs or if the emergency brake is still applied.

Green: 18 gauge wire, printed **#921 ENGINE TEMP SIGNAL**, this wire comes from the cooling temp sending unit on the engine. This wire is in the same pin location on the black ignition switch connector as the brown/white wire.

Green: 18 gauge wire, printed **#921 ENGINE TEMP SIGNAL/TEST**, this wire goes to the gauge cluster to provide the coolant temp gauge/light a ground signal for operation. This will provide a ground source to the coolant light on instrument clusters with indicator lights when the key in the start position. This will indicate that the bulb is operable.

The clear connector is a five pin connector with the following wires:

Pink/Black: 16 gauge wire, printed **#931 SWITCHED POWER TO "COIL" FUSE**, this wire provides power from the ignition switch to the COIL fuse on the fuse block. This wire will have power when the ignition switch is in the ON/RUN position as well as the START position.

Purple/white: 12 gauge wire, printed **#919 START SIGNAL (FROM IGN. SW. TO N. SAFETY)**, this wire will send power to the neutral safety/clutch switch to engage the starter solenoid. This wire will only have power when the ignition switch is in the START position.

Red: 12 gauge wire, printed **#934 IGNITION SWITCH POWER**, this wire comes from a buss bar on the fuse block and feeds power to the ignition switch. This wire will have power at all times.

Brown: 12 gauge wire, printed **#932 ACCESSORY POWER**, this wire carries power to the accessory fuses on the fuse block. These fuses are the A/C-HEAT, RADIO, and POWER WINDOW fuses. This **#932** wire will have power when the ignition is in the ACCESSORY position and when it is in the ON/RUN position.

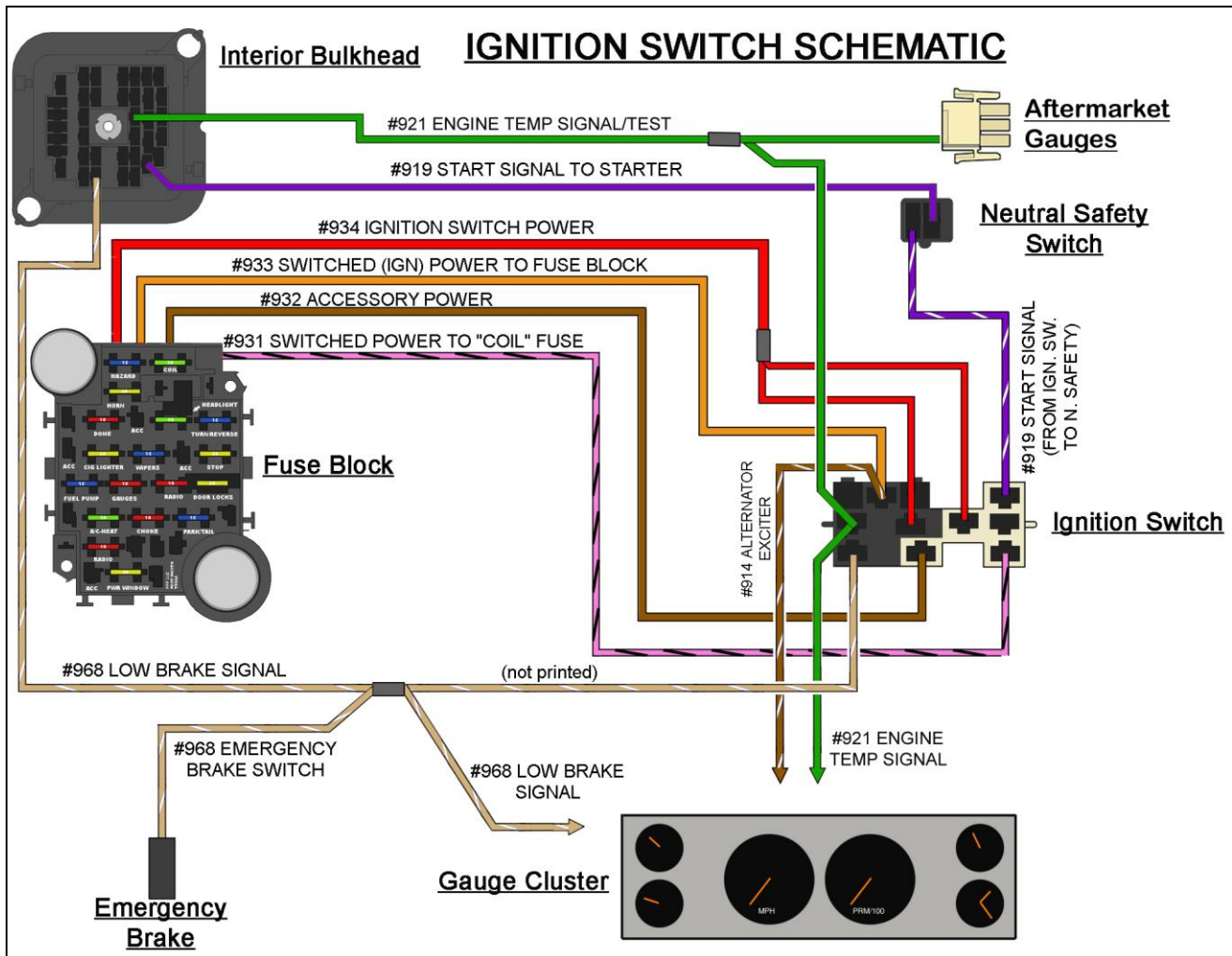

- Locate the ignition switch on the steering column, route the two connectors to the ignition switch.
- **The connectors must be installed in a specific order;** the clear connector will need to be connected first, and then the black. Part of the black connector will overlap the clear connector as seen in the photo below.

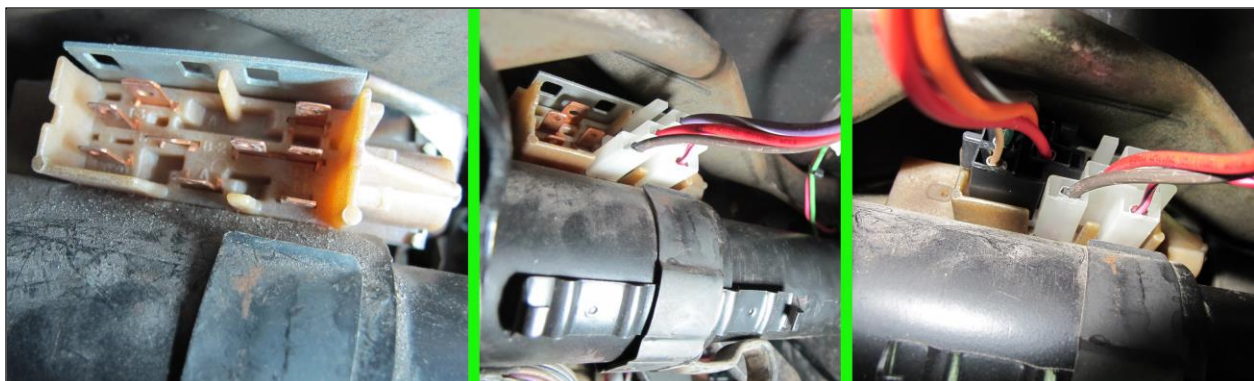

“Turn Signal Switch”

The column mounted turn signal switch will provide power to each turn signal indicator. The turn signal switch connection will exit the bottom of the steering column into a long black connector.

The connector found on the steering column will vary between the first years of the second generation Camaro and those used in the later years of production. Mates to both types of turn signal connectors have been provided with your new Painless harness, seen in the photos on page 77. The earlier production turn signal switch will require the smooth connector.

The wires provided in the Painless harness for turn signal connection can be identified by the section label reading “TURN SWITCH”. These will be ten pre-terminated wires that need to be plugged into the appropriate turn signal connector. These wires can be seen in the [Turn Signal Schematic](#) on the next page, they are:

Black: 18 gauge wire, printed **#966 KEY BUZZER SIGNAL**, this is a ground signal from the driver side door jamb switch. This wire will supply a ground signal to the turn switch to activate the key buzzer anytime the driver side door is open.

Pink/Black: 18 gauge wire, printed **#999 KEY BUZZER GROUND**, this is a ground activation signal to the key buzzer. The only time this wire will be grounded is when a key is in the ignition and the driver side door is open.

Black: 18 gauge wire, printed **#963 HORN RELAY GROUND ACTIVATION**, this wire is a ground activation signal to the horn relay. The only time this wire will be grounded is when the horn button on the steering wheel makes contact to a ground source.

Light Blue: 16 gauge wire, printed **#926 FRONT LEFT TURN SIGNAL POWER**, this wire will provide power to the left turn signal indicator on the gauge cluster as well as power to the front left turn signal. This wire will have power anytime the hazard switch is activated and also when the turn signal lever is in the down/left turn position and the ignition switch is in the ON/RUN position.

Blue: 16 gauge wire, printed **#925 FRONT RIGHT TURN SIGNAL POWER**, this wire will provide power to the right turn signal indicator on the gauge cluster as well as power to the front right turn signal. This wire will have power anytime the hazard switch is activated and also when the turn signal lever is in the up/right turn position and the ignition switch is in the ON/RUN position.

Brown: 16 gauge wire, printed **#951 HAZARD SWITCH POWER**, this wire provides power to the column mounted hazard switch. It comes from the hazard flasher found on the fuse block. It is a battery power wire but it will have power only when the hazard switch is activated, which causes the flasher to send power through this wire. See [Flashers](#) on page 16 for how this process works.

Purple: 16 gauge wire, printed **#952 TURN SIGNAL SWITCH POWER**, this wire provides power to the turn signal switch. It comes from the turn signal flasher found on the fuse block. It is an ignition power wire but it will have power only when the turn signal switch is activated, which causes the flasher to send power through this wire. See [Flashers](#) on page 16 for how this process works.

Yellow: 16 gauge wire, printed **#949 REAR LEFT TURN SIGNAL POWER**, this wire provides power to the left rear turn signal. This wire will have power anytime the hazard switch is activated and also when the turn signal lever is in the down/left turn position and the ignition switch is in the ON/RUN position. On 1970-1976 Camaros, this wire also carries the brake light power wire. In those cases this wire will also have power anytime the brake pedal is pressed.

Green: 16 gauge wire, printed **#948 REAR RIGHT TURN SIGNAL POWER**, this wire provides power to the right rear turn signal. This wire will have power anytime the hazard switch is activated and also when the turn signal lever is in the up/right turn position and the ignition switch is in the ON/RUN position. On 1970-1976 Camaros, this wire also carries the brake light power wire. In those cases this wire will also have power anytime the brake pedal is pressed.

White: 16 gauge wire, printed **#918 BRAKE SWITCH OUTPUT**, this wire will feed the brake light power into the turn signal switch on 1970-1976 Camaros. These vehicles have integrated brake/turn signals. Meaning, the turn signal and brake light share a filament in the bulb. This wire will have power anytime the brake pedal is pressed.

Those with a 1977-1981 Camaro will not need this white #918 wire.

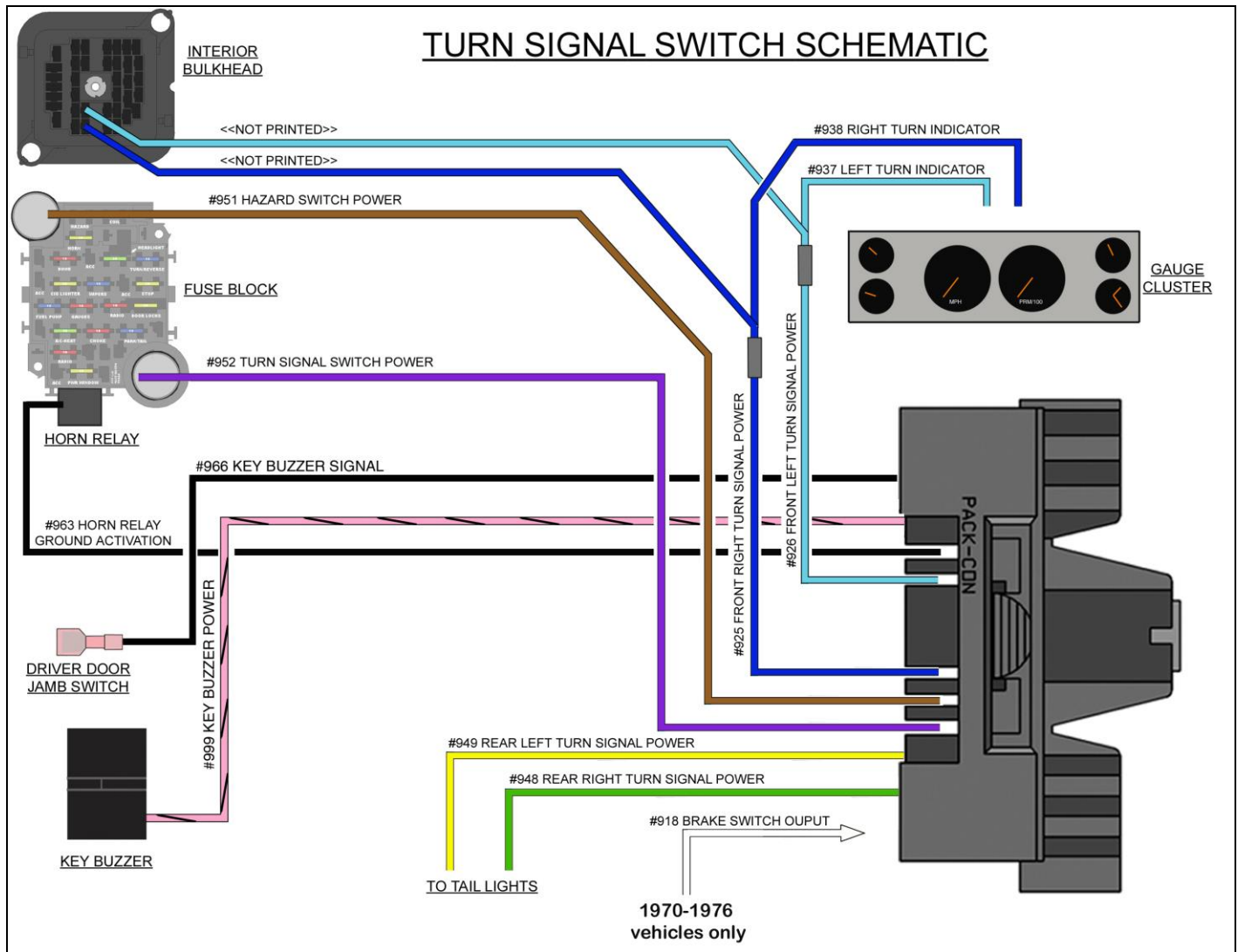

- Locate the turn signal connector in the parts kit that mates to the connector on your column, as seen on the next page.

- One by one, plug the wires of the “TURN SWITCH” group of wires on the Painless harness into the connector according to the drawing below. Pay close attention to the two black wires, do not get them crossed. Also note, the white wire #918 will not be used on 1977-1981 Camaros; pin P of the connector will remain empty. This wire will need to have the end taped /insulated to avoid shorts.

The terminals will only insert into the connector ONE WAY, as shown below. Make certain you are inserting the wire into the CORRECT LOCATION as the terminals are very difficult to remove once inserted.

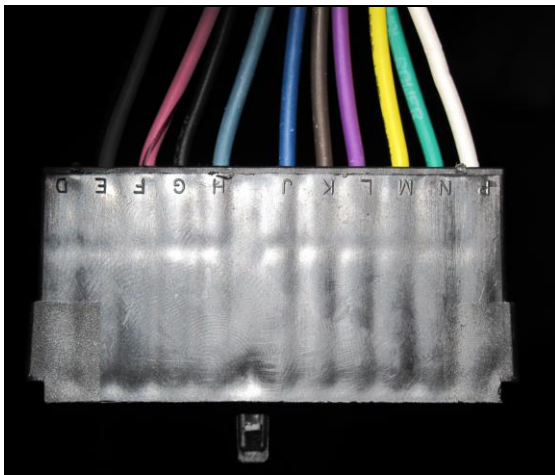
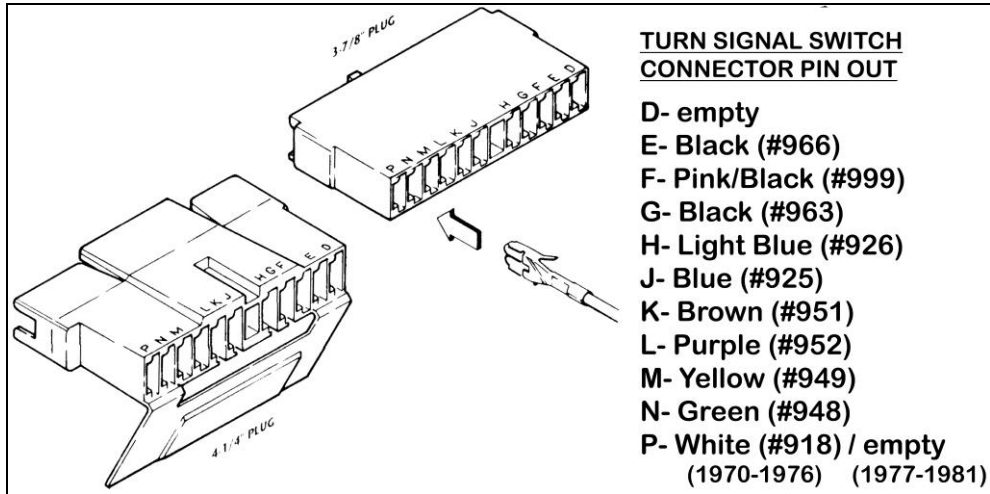

Early Turn Signal Connector

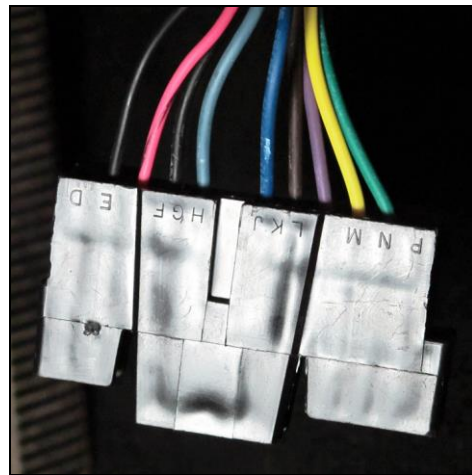

Late Turn Signal Connector

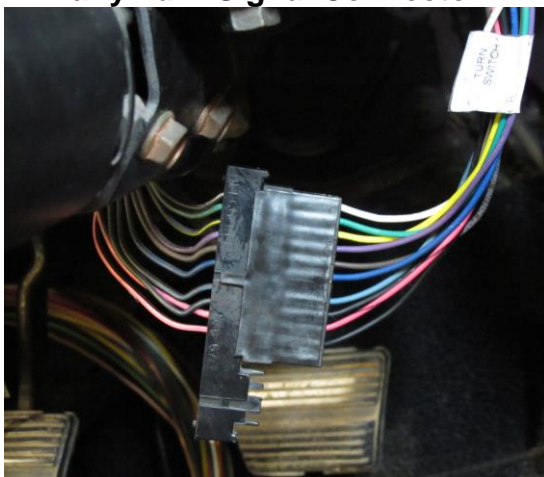

“Radio”

The radio connection on the Painless harness is set up for a universal application since most Camaros no longer have the factory radio in place. The two power wire colors used by Painless reflect the colors most aftermarket companies’ use on radios manufactured today.



The Painless harness includes four wires dedicated for a connection to the radio. The wires can be identified by a section label reading “RADIO”. These four wires are:

Yellow: 16 gauge wire, printed **#940 RADIO BATTERY POWER (MEMORY)**, this wire will provide the radio a battery power source that will allow the time and radio presets to remain every time the ignition is turned off. This wire comes from the 10 amp RADIO fuse found towards the middle of the fuse block. This wire can be seen in the [Accessory Schematic](#) on page 82.

Red: 16 gauge wire, printed **#941 RADIO SWITCHED POWER**, this wire will provide the radio with ignition switched power for operation. This wire will have power when the ignition switch is in the ACCESSORY and ON/RUN positions. This wire comes from the 10 amp RADIO fuse on the lower part of the fuse block. This wire can be seen in the [Accessory Schematic](#) on page 82.

Black/White: 16 gauge wire, printed **#969 RADIO GROUND**, this wire will supply a ground source to the radio. This wire is part of the integrated ground circuit of the Painless harness. This wire can be seen in the [Ground Schematic](#) on page 15.

Gray: 18 gauge wire, printed **#930 RADIO BACKLIGHT DIM**, this wire will provide a power signal to the radio to dim the back lighting/display during low light conditions. On older radios this power source will illuminate the backlighting. The gray #930 is tied to the other #930 wires coming from the headlight switch to things like the gauge lights, panel lights, and gear indicator light. This wire will have power anytime the headlight switch is in the Park/Tail Lights ON or Headlights On position. This wire can be seen in the [Headlight Switch Schematic](#) on page 97.

- Those reusing a factory radio, Yellow wire #940 will not be used, this wire will need to have the end taped /insulated to avoid shorts. The factory connector will need to be reused. Red #941 will connect to the factory yellow wire, Gray #930 will connect to the gray wire, and Black/White #969 will connect to the black wire. Splices and quick disconnect terminals have been provided in the parts kit.
- If you are using an aftermarket radio, refer to the manufacturer’s installation guide for proper connection. Splices and quick disconnect terminals have been provided in the parts kit.

The next set of connections will follow the harness up, towards the gauge cluster panel area. These connections require the gauge cluster to be removed from the dash.

“Cigarette Lighter/Power Port”

The Cigarette Lighter/Power Port connection on the Painless harness is set up for a universal application since the factory connector is no longer produced. This connection is a simple two wire, power and ground, connection. In many applications, the cigarette lighter is more commonly used as a power port to charge cell phones and run other electronic components requiring a 12vDC power source.

If you are using an aftermarket cluster panel, you may not have a hole pre-drilled for this component. Extra length has been provided to mount a Cigarette Lighter/Power Port elsewhere on the dash.

The Cigarette Lighter/Power Port connection will be two wires with a section label reading “CIG. LIGHTER”, these wires are:

Orange: 16 gauge wire, printed **#903 CIGARETTE LIGHTER POWER**, this wire will provide constant battery power. This wire comes from the 20 amp CIG LIGHTER fuse on the fuse block and can be seen in the [Accessory Schematic](#) on the next page.

Black; 16 gauge wire, printed **#969 CIGARETTE LIGHTER GROUND**, this wire provides a ground source. This wire is tied into the integrated ground circuit and can be seen in the [Ground Schematic](#) on page 15.

- Route the #903 and the #969 wires to the cigarette lighter/power port.
- Cut the wires to length and connect according to one of the following:
 - Ring terminals and bullet/socket/spade style terminals have been provided in the parts kit to connect universal aftermarket lighters/power ports. Universal Lighter socket part #56458 can be seen below. This socket can be found at most local parts store.
 - You can cut the connector from your factory harness, as shown below, leaving 3” or 4” of wire to create a pigtail to splice it to the wires of the Painless kit. Match the Orange factory wire to the Orange #903 wire and the black factory wire to the black #969 wire. Splices have been provided in the parts kit.

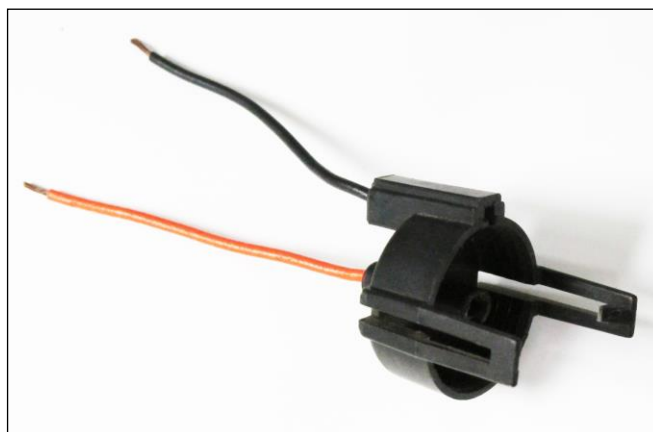

ACCESSORY SCHEMATIC

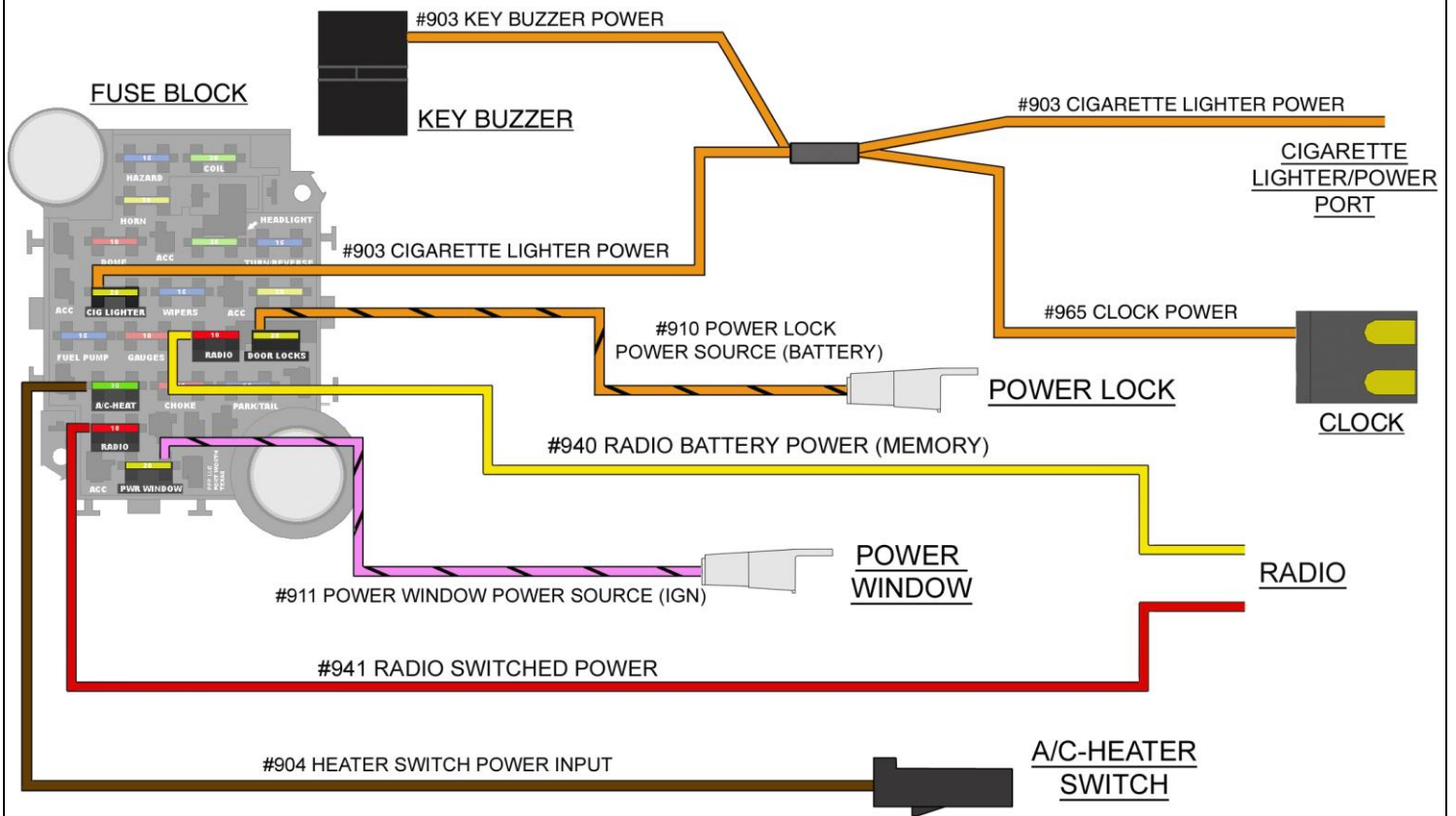

“Clock”

The clock connection will provide power and ground to allow proper operation of the clock found on factory instrument clusters that have gauges. Instrument clusters with indicator lights instead of gauges did not have a clock. Both clusters, with and without the clock can be seen on pages 86 & 87.

Those without a clock can skip this connection and go on to the next component, the Instrument cluster. Wrap a piece of electrical tape around the exposed terminals of the clock connector to avoid them shorting to the metal of the dash.

The clock connection will be a two pin black connector with a section label reading “CLOCK”, these wires going into this connector are:

Orange: 18 gauge wire, printed **#965 CLOCK POWER**, this wire will provide constant battery power. This wire comes from the 20 amp CIG LIGHTER fuse on the fuse block and can be seen in the [Accessory Schematic](#) above.

Black; 16 gauge wire, printed **#969 CIGARETTE LIGHTER GROUND**, this wire provides a ground source. This wire is tied into the integrated ground circuit and can be seen in the [Ground Schematic](#) on page 15.



- With the cluster removed, route and connect the clock connector to the two tabs of the clock in the lower left corner of the cluster, as seen below.
- Ring terminals and bullet/socket/spade style terminals have been provided in the parts kit to connect universal aftermarket clock if one is being installed in place of the factory clock.

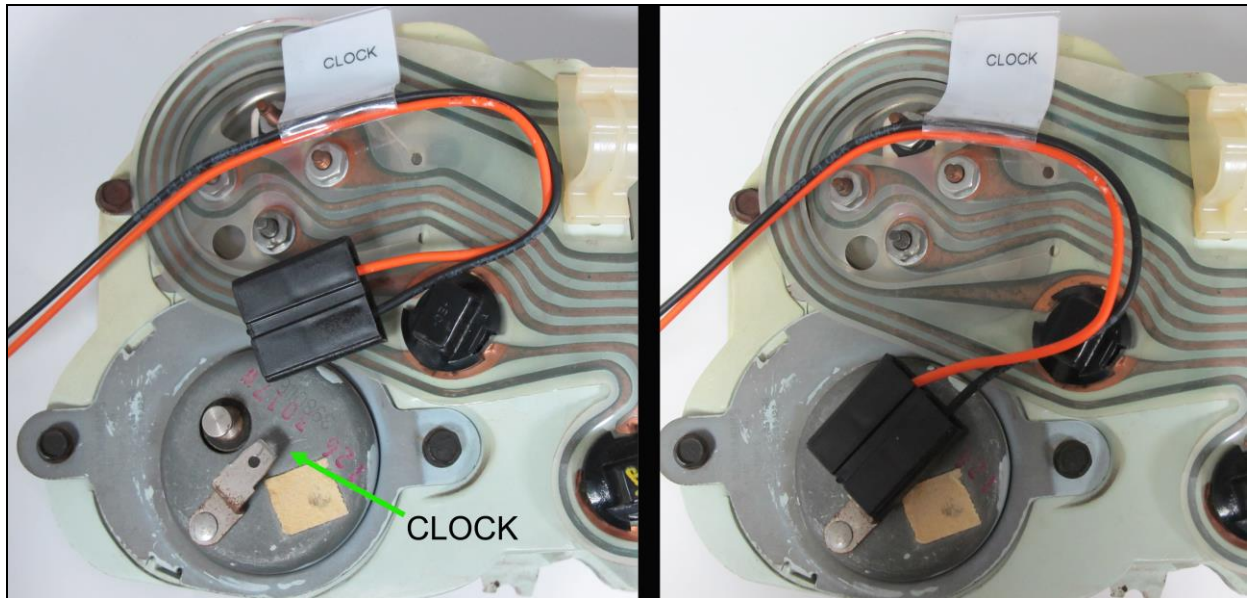

Instrument Cluster

The instrument cluster connection of the Painless harness will vary according to the gauge cluster or aftermarket gauges you are using. First, before any connections can be made to the gauges, we need to address the alternator exciter connectors; these were not found on the factory harness. **If you are using a one wire alternator, this connection can be skipped, go to page 86.**



Alternator Exciter Connectors

Based on the instrument cluster you are using and/or the use of a charge indicator light, connection of the alternator exciter connectors will vary. These wires provide the switched power source required to excite the voltage regulator allowing the alternator to produce voltage. These are the two small white connectors seen in the lower right corner of the photo above, these wires are:

Brown/White: 16 gauge wire, printed **#914 ALTERNATOR EXCITER**, this wire provides an ignition power source for the voltage regulator from the ignition switch. This wire will only have power when the ignition is in the ON/RUN position.

Brown/White: 16 gauge wire, printed **#914 ALT. EXCITER/CHARGE INDICATOR**, this wire provides an ignition power source to the voltage regulator.

These wires must be connected in one of the following three methods. If they are left untouched, and your alternator requires a 12v exciter, your alternator WILL NOT CHARGE.

Those using a cluster with a charge indicator light or adding a charge indicator light, the light will function like this:

Power will come into one side of the light, power will pass through the light to the voltage regulator. Power moving through the filament will cause the light to illuminate. This light will illuminate when the key is in the ON/RUN position and the alternator is not charging because the engine is not running or the alternator is not working properly. Once the alternator is charging the voltage regulator no longer needs power, which stops the flow of power. Since power is no longer flowing through the filament, the bulb does not illuminate.

Method #1) For factory clusters with indicator lights (generator light)

- Locate the bag provided with the painless kit labeled “CHARGE INDICATOR”. This will have a simple one wire pigtail inside.
- Connect this “CHARGE INDICATOR” pigtail to the mating white connector, this will be the wire circled in the picture, printed **#914 ALT. EXCITER/CHARGE INDICATOR**. This pigtail has a terminal pre-installed on one end that will fit into the gauge cluster connector. This will allow voltage to go from the gauge cluster, to the voltage regulator.

The other white connector on the Painless harness that runs to the ignition switch, wire **#914 ALTERNATOR EXCITER**, will not be used.

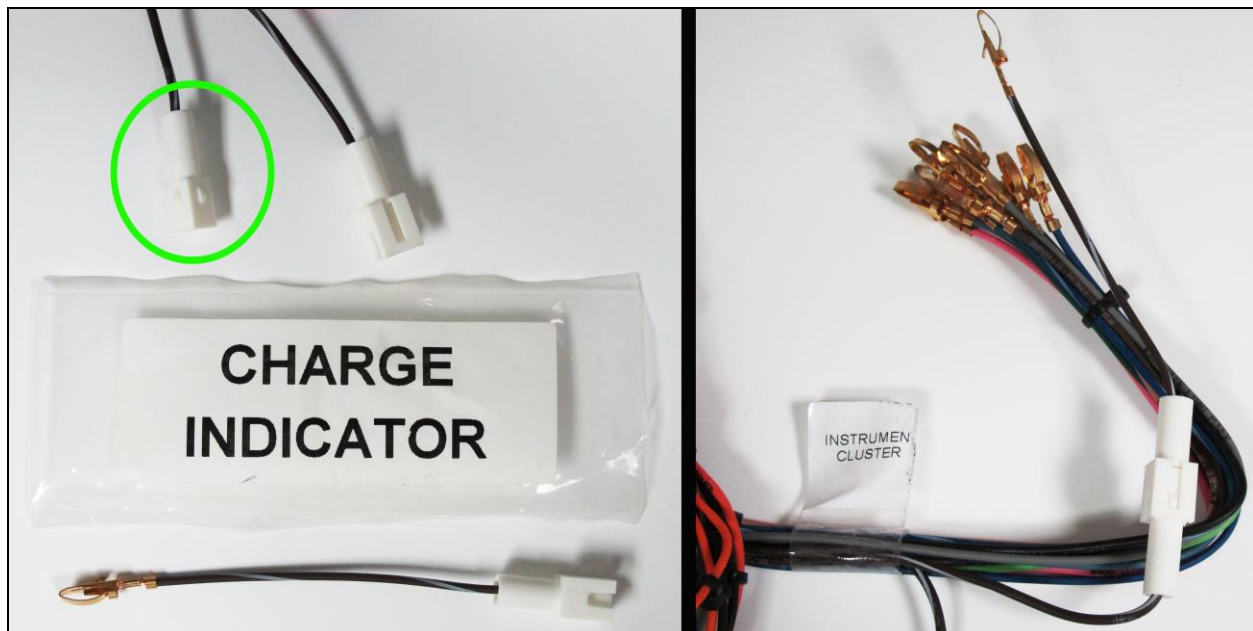

Method #2) For factory clusters with gauges (aka U14) & aftermarket gauges without a charge indicator light:

- Connect the two small white connectors on the Painless harness together, seen highlighted in the photo below. This will send power from the ignition switch to the voltage regulator. The “CHARGE INDICATOR” pigtail provided with the kit will not be needed.

These two white connectors will only be connected if you **DO NOT** have an indicator light.

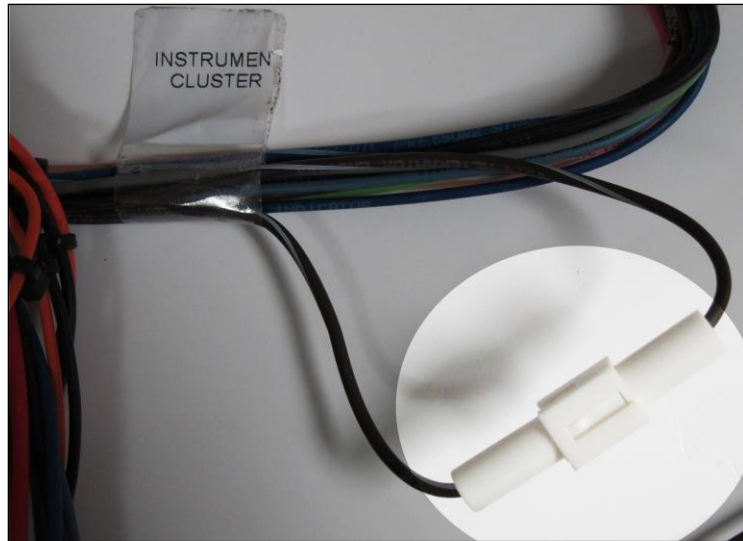

Method #3) Aftermarket Charge Indicator Light

Those with aftermarket gauges or even those with a factory cluster may opt to install a charge indicator light in the dash or elsewhere. These lights are typically a two wire install.

- Cut the white connectors from the Painless harness.
- Connect a wire for power into the light, wire **#914 ALTERNATOR EXCITER**, and power out of the light to the voltage regulator, wire printed **#914 ALT. EXCITER/CHARGE INDICATOR**. See the diagram below. Splices have been provided in the parts kit for this type of connection.



It is also recommended, but not necessary, to wire in a 15 ohm 2 watt resistor between the power in and power out, seen in the diagram below. This will still provide enough power to the voltage regulator to allow the alternator to still charge in the event the bulb burns out. This resistor can be found through online electronic component suppliers such as Mouser or Allied Electronics under part # OY150KE.

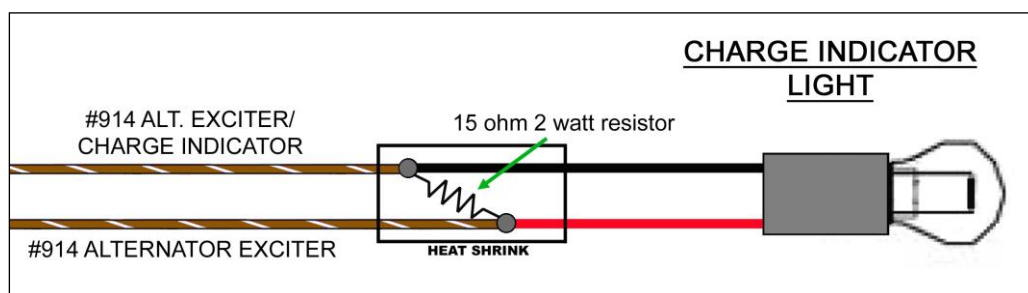

Pre-Terminated Wires



The second generation Camaro had two different styles of gauge clusters. One with actual gauges for the temp and voltage; this cluster also has a tachometer. This cluster is more commonly known as “U14” gauges in reference to the factory RPO code for this option. The other cluster only has a fuel gauge; everything else is an indicator light. Both clusters can be seen on pages 86 & 87.

The connector for the instrument cluster has not been pre-installed. Both clusters use the same connector, however the pin outs change based on which cluster you have. The wires for this connection have the terminals pre-installed, these wires are:

Black: 16 gauge wire, printed **#969 INSTRUMENT CLUSTER GROUND**, this wire provides a ground source. This wire is tied into the integrated ground circuit and can be seen in the [Ground Schematic](#) on page 15.

Gray: 18 gauge wire, printed **#930 GAUGE LIGHT POWER**, this wire will provide a power to the cluster back lighting. The gray #930 is tied to the other #930 wires coming from the headlight switch to things like the radio backlight/dim, panel lights, and gear indicator light. This wire will have power anytime the headlight switch is in the Park/Tail Lights ON or Headlights On position. This wire can also be seen in the [Headlight Switch Schematic](#) on page 97.

Tan: 18 gauge wire, printed **#939 FUEL LEVEL SIGNAL**, this wire is a ground signal from the fuel level sending unit in the fuel tank. The resistance to ground will vary on this wire according to how much fuel is in the tank. This wire can also be seen in the [Tail Harness Ground Schematics](#) on pages 117, 128, and 137.

2 Pink: 18 gauge wires, both printed **#935 GAUGE POWER**, these wires provide a switched ignition power source to the cluster. These wires come from a splice of a pink wire that comes from the 10 amp GAUGES fuse on the fuse block. This wire will have power anytime the key is in the ON/RUN position. See the [Gauge Power Schematic](#) on page 95.

Green: 18 gauge wire, printed **#921 ENGINE TEMP SIGNAL/TEST**, this wire is a ground signal from the engine coolant sending unit. The resistance to ground will vary on this wire according to engine temperature. This wire can also be seen in the [Ignition Switch Schematic](#) on page 76.

Brown: 18 gauge wire, printed **#923 TACH SIGNAL**, this wire is a ground signal from the negative side of the ignition coil. This wire can also be seen in the coil connection diagrams on pages 39 & 40.

Blue/White: 18 gauge wire, printed **#922 OIL PRESSURE SIGNAL**, this wire is a ground signal from the oil pressure sending unit. The resistance to ground will vary on this wire according to oil pressure.

Tan/White: 18 gauge wire, printed **#968 LOW BRAKE SIGNAL**, this wire is a ground activation wire for the brake light on the cluster. This wire will be grounded, causing the light to illuminate when low brake fluid pressure condition occurs, if the emergency brake is still applied, and when the ignition is in the ON/RUN position without the engine running. This wire can also be seen in the [Ignition Switch Schematic](#) on page 76.

Light Blue: 18 gauge wire, printed **#937 LEFT TURN INDICATOR**, this wire is a power activation wire for the left turn signal indicator. This light blue wire is spliced into the wire going to the front left turn signal. It will have interrupted switched ignition power, through the turn flasher, anytime the left turn signal is activated. It will also have interrupted switched battery power, through the hazard flasher, anytime the hazard switch is activated. This wire can also be seen in the [Turn Signal Switch Schematic](#) on page 78.

Light Green: 18 gauge wire, printed **#936 HIGH BEAM INDICATOR POWER**, this wire is a power activation wire for high beam indicator. This wire is spliced into the wire coming from the high beam side of the dimmer switch, to the headlights. This wire will have power anytime the headlight switch is in the HEADLIGHT ON position and the dimmer switch in the HIGH BEAM position. This wire can also be seen in the [Front Exterior Light Schematic](#) on page 31.

Blue: 18 gauge wire, printed **#938 RIGHT TURN INDICATOR**, this wire is a power activation wire for the right turn signal indicator. This blue wire is spliced into the wire going to the front right turn signal. It will have interrupted switched ignition power, through the turn flasher, anytime the right turn signal is activated. It will also have interrupted switched battery power, through the hazard flasher, anytime the hazard switch is activated. This wire can also be seen in the [Turn Signal Switch Schematic](#) on page 78.

If you are using aftermarket gauges skip to the aftermarket gauge section on page 90 at this time. If you are simply adding aftermarket gauges to the vehicle, but still utilizing a factory gauge cluster, connect the Instrument cluster wires according to the type of factory cluster you have. Wiring for additional aftermarket gauges is supported with the Painless harness and will be handled later in the manual, on page 104.

- Locate the black 12 way gauge cluster connector in the parts kit. Seen in the photo to the right.
- Connect the wires of the “INSTRUMENT CLUSTER” section according to the diagram on pages 88 or 89 that matches the cluster you are using. Zip ties pre-installed on the instrument cluster wires may need to be removed in order for all the wires to reach their designated pin locations. All diagrams show the side of the connector the wire/terminal fits into. Also notice the numbered locations on the side of the connector, 1-6 seen in the connector photo, as well as the numbers in the diagrams.



Factory Instrument Cluster w/Indicator lights (no gauges)

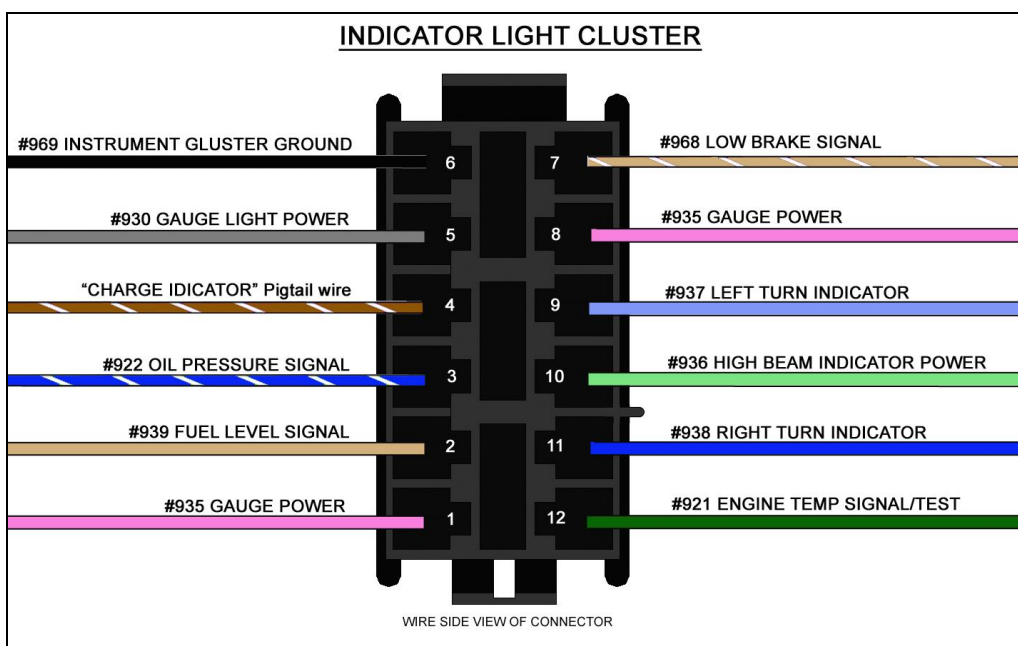

- With the connector properly pinned out, and **double checked for accuracy**, plug the connector into the back of the gauge cluster. If the connector is pinned out incorrectly you can and will burn up the printed circuit on the cluster. The ends of the connector will have a tab; you will notice one tab is bigger than the other is. Notice the openings on the cluster differ from one another to accept these different tabs; this is to ensure the connector is connected properly.

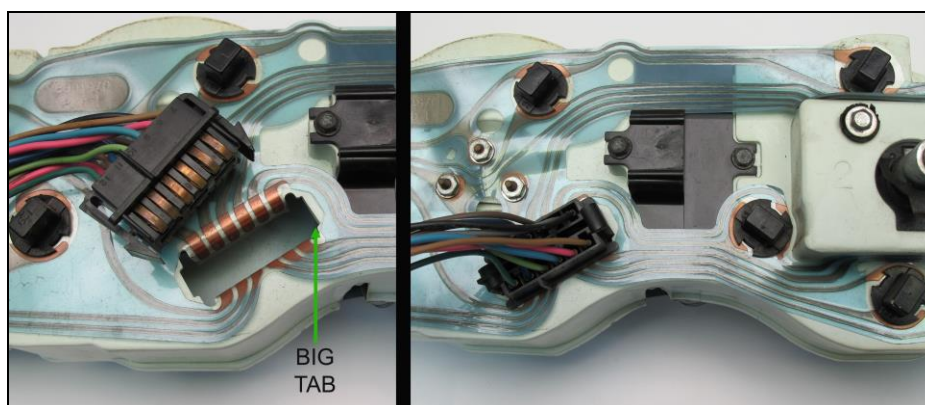

Factory Instrument Cluster w/ Gauges (U14)

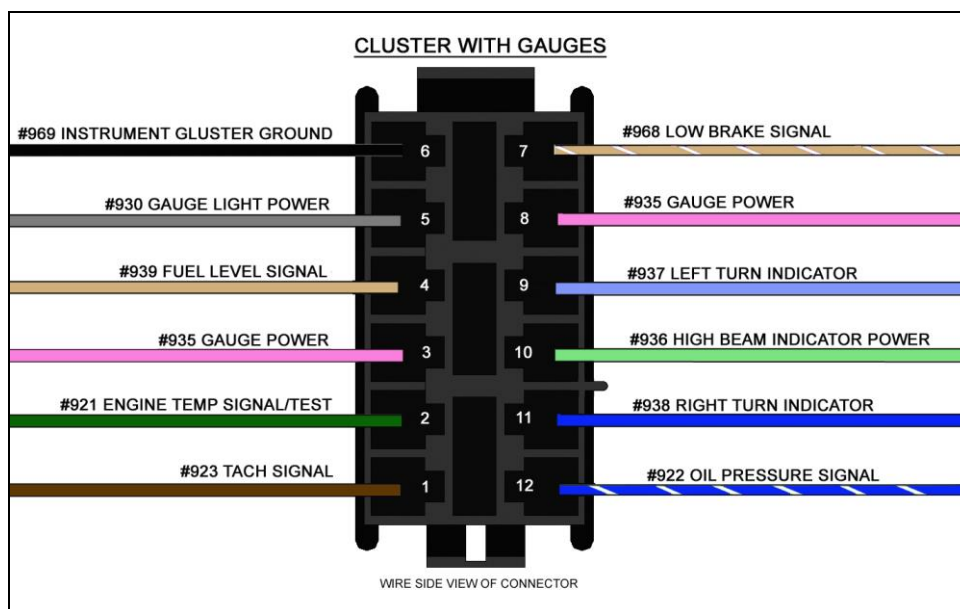

- With the connector properly pinned out, and **double checked for accuracy**, plug the connector into the back of the gauge cluster. If the connector is pinned out incorrectly you can and will burn up the printed circuit on the cluster. The ends of the connector will have a tab; you will notice one tab is bigger than the other is. Notice the openings on the cluster differ from one another to accept these different tabs; this is to ensure the connector is connected properly.

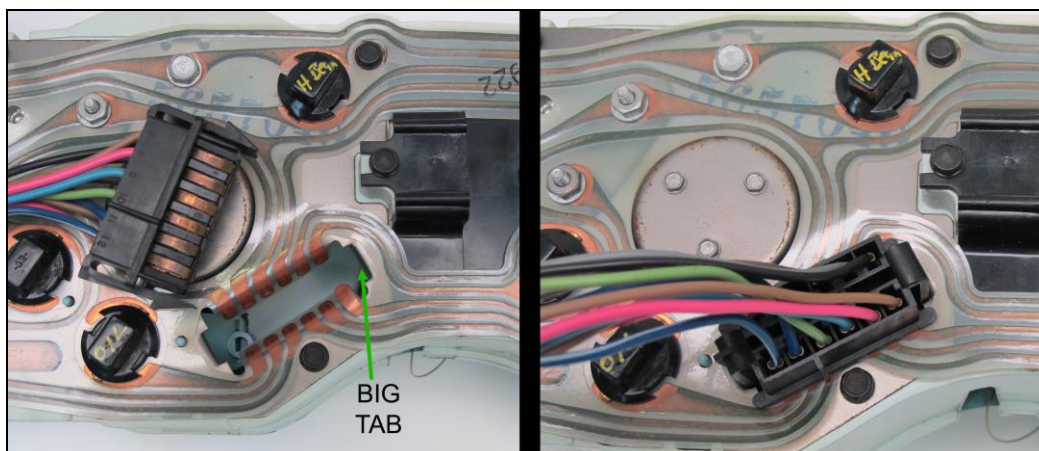

Aftermarket Gauges

The following set of instructions is for those completely replacing the factory gauge cluster with aftermarket gauges. If you are installing aftermarket gauges elsewhere on the dash, or near the console area, wiring for additional aftermarket gauges in these locations is supported in the Painless harness and will be handled later in the manual in a different section of wires, "Aftermarket Gauges" on page 104.

The following instructions will be universal in nature due to all the different manufacturers of aftermarket gauges. Use the following instructions along with the gauge manufacturer's instructions.

Most electric aftermarket gauges require five wire connections:

- Gauge Power- a Switched 12 volt power source
- Gauge Ground
- Signal- from a sensor or sending unit
- Gauge Light Power- 12 volt power source from the Gauge Lighting circuit
- Gauge Light Ground

Most mechanical aftermarket gauges only require two wires to be connected:

- Gauge Light Power- 12 volt power source from the Gauge Lighting circuit
- Gauge Light Ground

All of these connections are already present in the wiring for the factory instrument cluster. Additional length may need to be added to some wires, as the wires of the Painless harness have all been pre-cut according to the factory gauge cluster.

There are two methods to connecting aftermarket gauges, separate harness and hard wiring:

Separate harness:

To facilitate wiring aftermarket gauges, Painless offers and recommends the use of [Painless part # 30301 \(#30302 if using an electric speedometer\)](#). This will be a universal gauge cluster harness that has all the splicing and termination pre-installed for these types of applications. This harness will also offer you the benefit of having an inline connector instead of hardwiring the chassis harness directly to the gauges.



- Cut the pre-installed brass terminals from the instrument cluster wires.
- Using the terminals and connector found in the 30301 or 30302 kit, install the wires of this Camaro chassis harness according to the diagram below. Use the numbers on the connectors as well as the circled reference points in the diagram for proper cavity location.

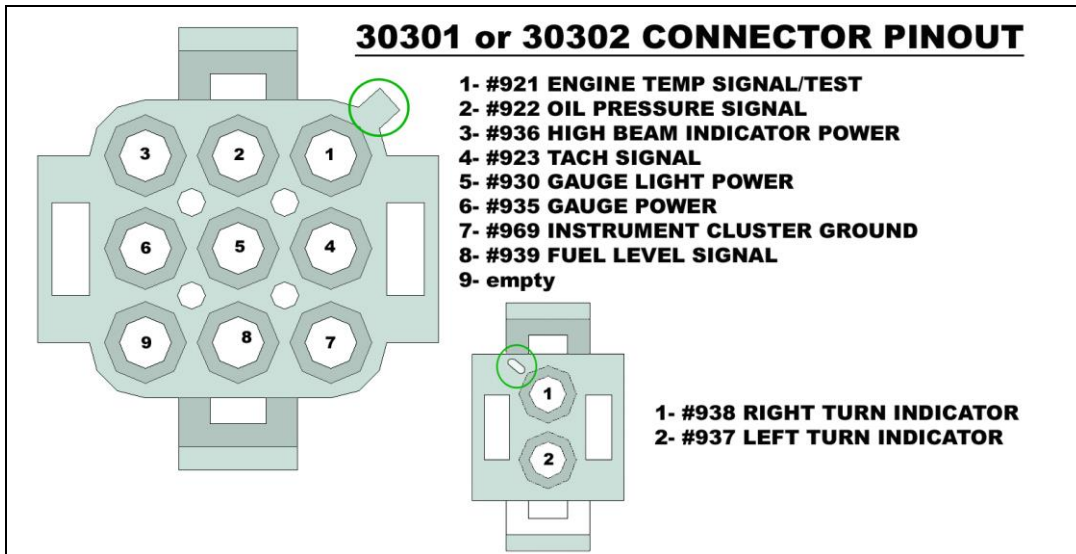

Hard Wiring:

Those choosing to wire aftermarket gauges with just the wires found in the Painless chassis harness, and not purchasing an additional gauge harness, the following steps will walk you through the process of distributing power and ground, as well as connecting the sender wires. The following diagrams only show temp, oil pressure, volt and fuel level gauges. Power, ground and sender wires will connect in the same manner to speedometers and tachometers.

Power to the gauges will need to come from the pink **#935 GAUGE POWER** wires and/or the pink **#935 VOLTMETER POWER** wire which can be found farther down the harness. Power will need to be connected to the “I” or “12v” post on the gauge. The power wire can be connected in one of two ways:

#1) Splicing- Splice off one of the #935 wires and running wires to several gauges and splicing off the other #935 wire and running wires to the remaining gauges.

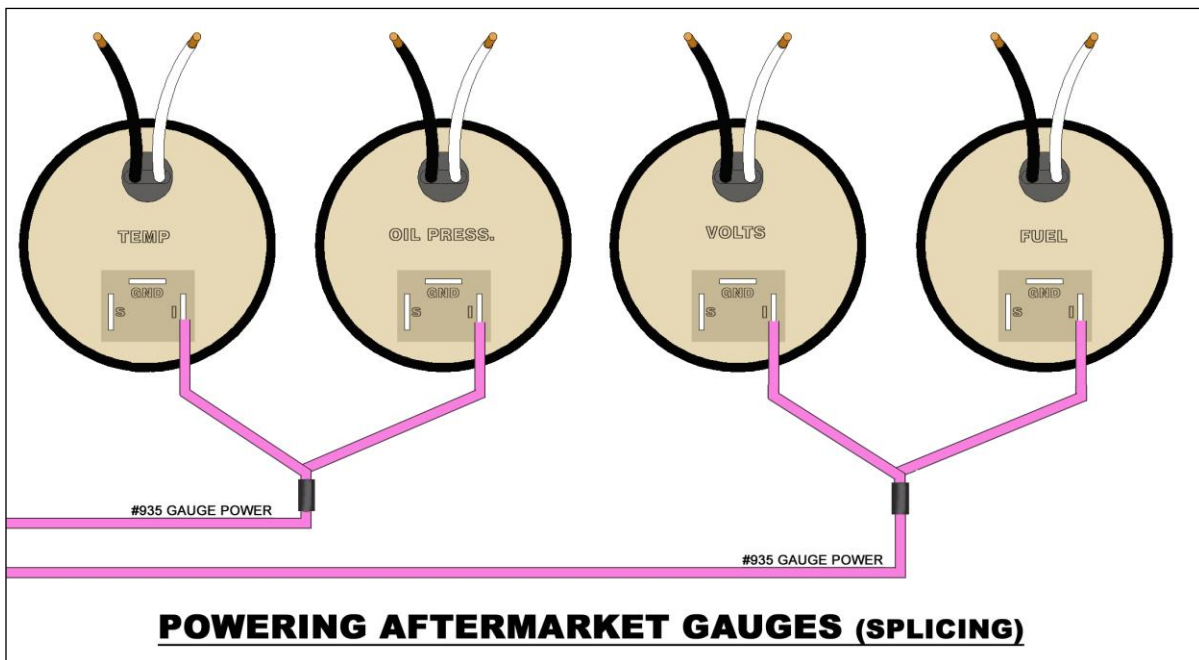

#2) Chaining or Jumpering- Run one of the #935 wires to a power post, before terminating the wire with the proper terminal, you will insert another wire into the terminal and crimp. You will now have 2 wires in one terminal. This additional wire will then route to the power post on another gauge. Before terminating the wire with the proper terminal, you will insert another wire into the terminal; and so on.

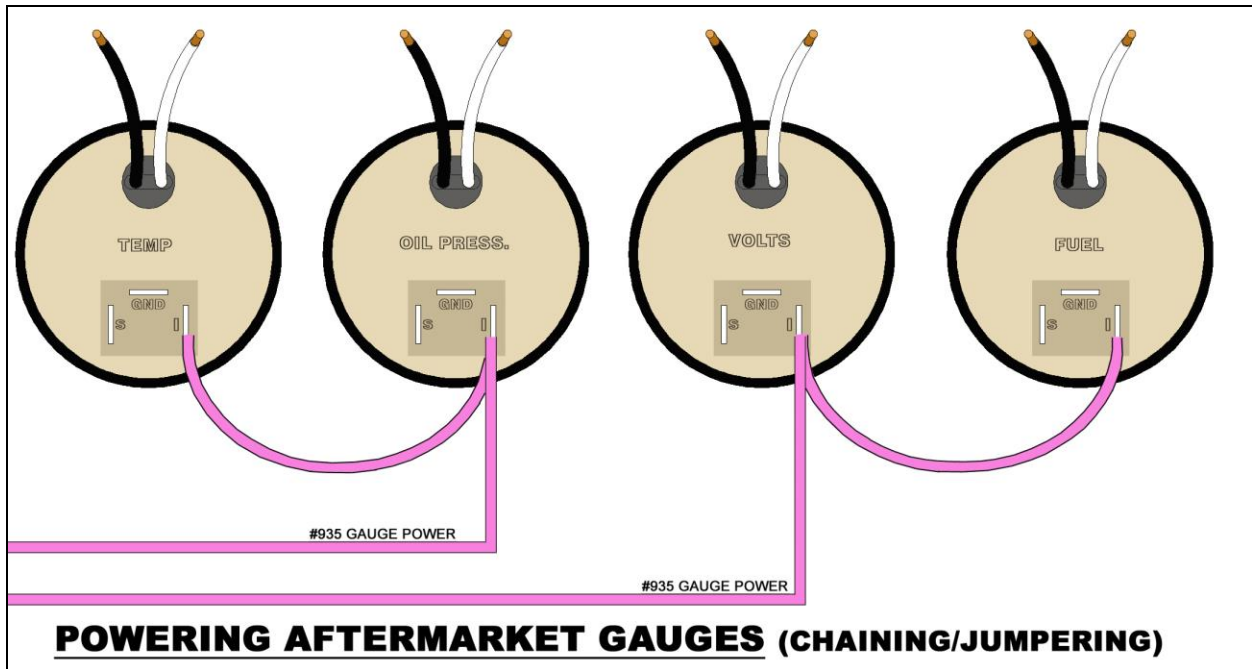

Grounds will need to be supplied to the gauge lights and to any ground tab on the gauges. These grounds can come from the black **#969 INSTRUMENT CLUSTER GROUND** wire and/or seeing that a good ground source is not hard to find on these vehicles, the installer could run their own ground circuit for gauge connections. To make these ground connections you can splice from this #969 wire to all the gauges or chain/jumper it all together. Both methods seen in the following two drawings:

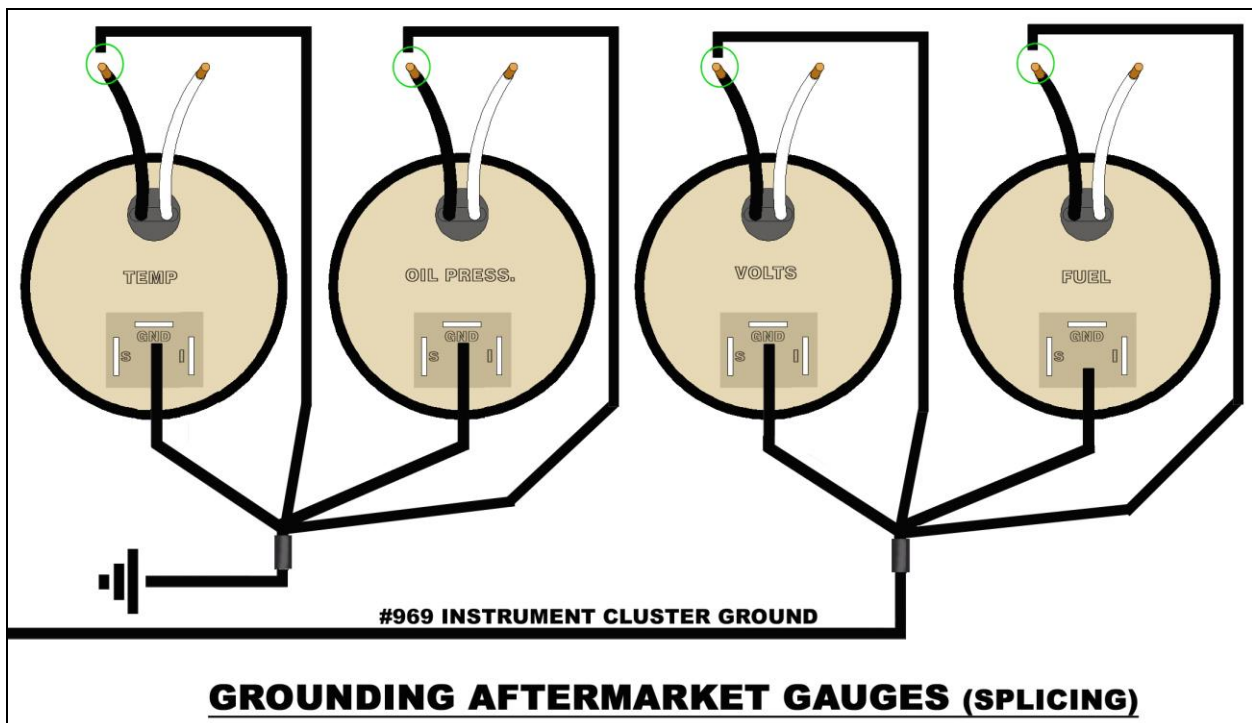

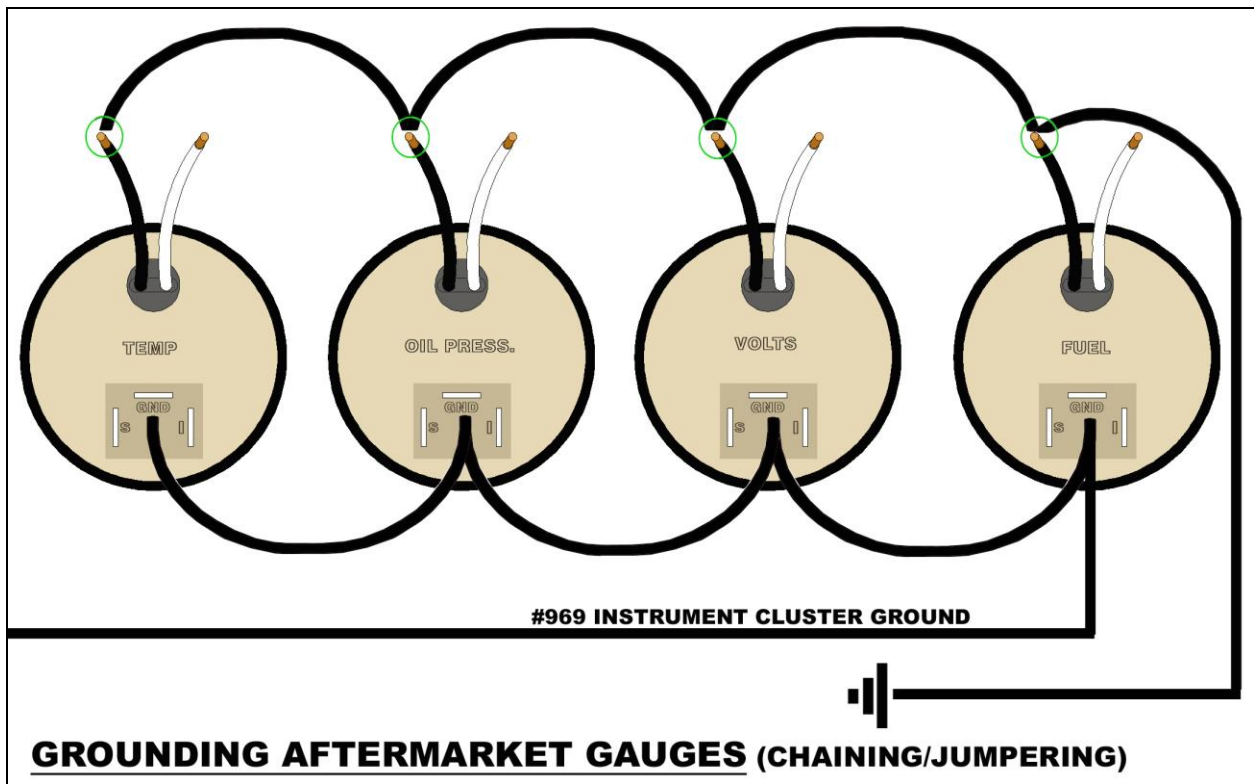

Gauge light power will be supported by the gray **#930 GAUGE LIGHT POWER** wire. This wire will connect to one of the leads for the gauge light, or to the gauge light tab found on gauges with LED backlighting. To make these connections you can splice from this #930 wire to all the gauges or chain/jumper it all together.

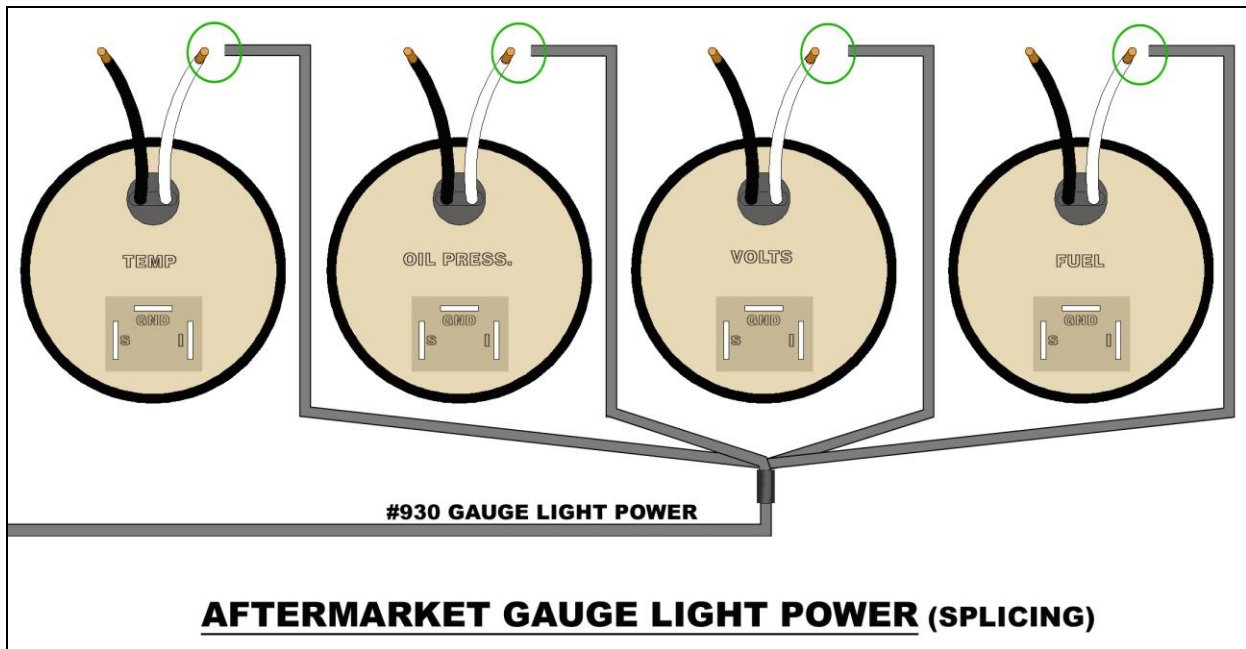

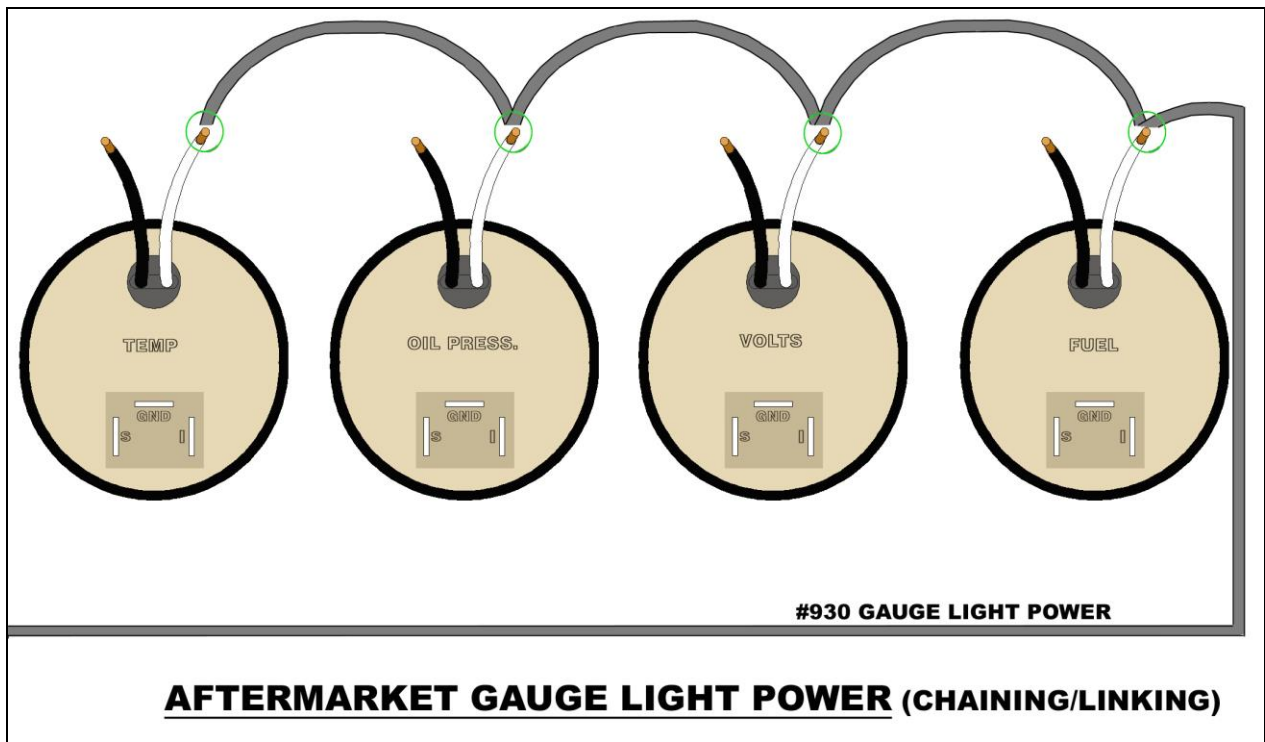

The last connection needing to be made will be the sending unit wires or signal wires. These will be the wires which come from the temperature sending unit, oil pressure sending unit, and fuel level sending unit. Not shown in the diagram, but also provided in the Painless chassis harness is the brown #923 TACH SIGNAL wire.

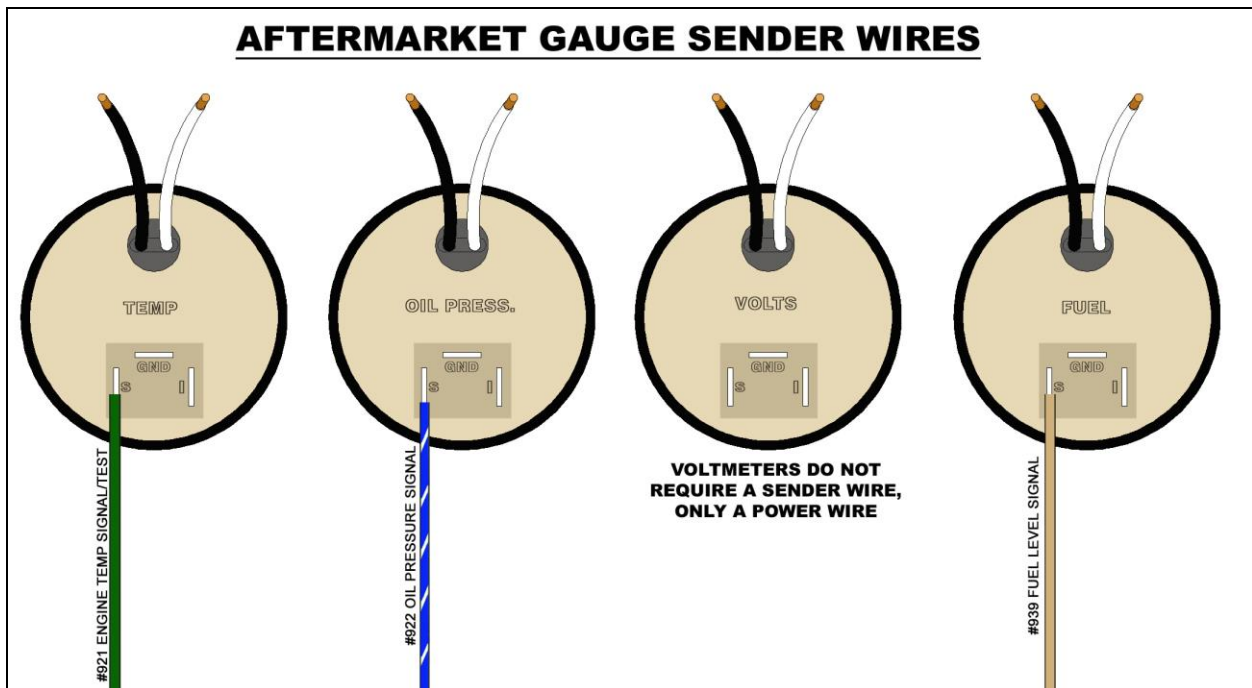

This concludes the connection of the wires labeled “INSTRUMENT CLUSTER”

“Voltmeter”

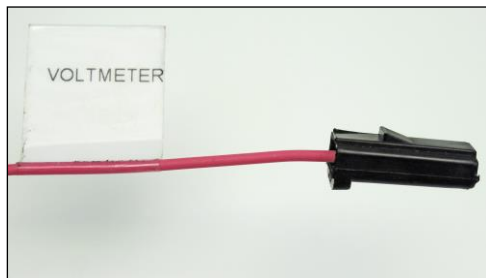

This connection will provide a power source to the voltmeter on factory clusters that had gauges instead of indicator lights. This connection will be a single pin black connector. The wire going into this connector will be:

Pink: 18 gauge wire, printed **#935 VOLTMETER POWER**, this wire will provide an ignition switched power source to the voltmeter. This wire comes from a splice with the **#935 GAUGE POWER** wire from the 10 amp **GAUGE** fuse on the fuse block. This wire can be seen in the [Gauge Power schematic](#) below.

- Connection will be as easy as simply installing the black single pin connector onto the tab coming off the back of the voltmeter. Looking at the back of the cluster, this will be in the bottom right corner.

Those installs that do not have a voltmeter will not have a need for this wire. It can remain unconnected; however the end of the connector should be wrapped in electrical tape to avoid any shorts.

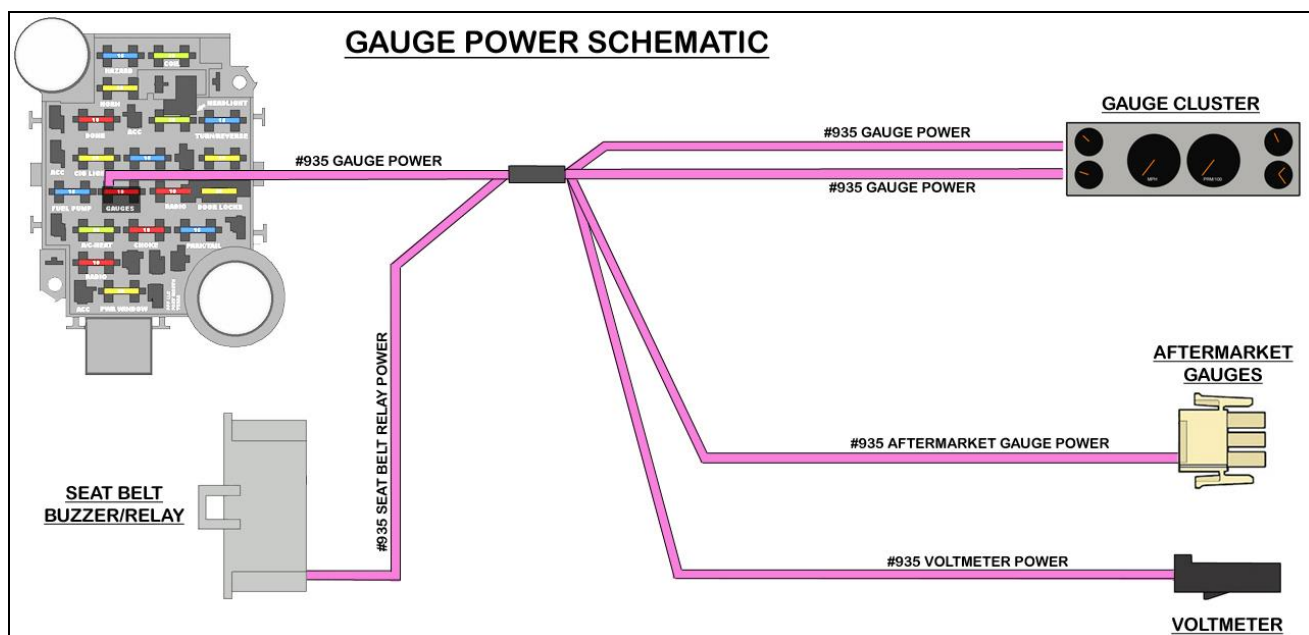

Headlight Switch

The headlight switch connection will control function of the park/tail lights, headlights, gauge lights, and the dome/courtesy lights. This will be a three way switch:

- The first pull of the headlight switch will send power to illuminate the park lights, tail lights, and also the backlighting for the gauges.
- The second pull of the switch will still provide power to everything listed above, but will now send power to the dimmer switch which will then route power to the high beam or low beam headlights depending on the dimmer switch position.

- The third position is dome light/courtesy light control and gauge dimming. By rotating the knob to the left and right, you can dim/brighten the gauge backlighting. This is done through the rheostat (the coiled metal that looks like a spring) on the switch that resists the power going to the gauge lights. Turn the knob to the left to make the gauges brighter, all the way to the left you will feel a click, this click will provide a ground source out to the interior lighting circuit causing the dome/courtesy lights to come on without opening a door. Turning the knob to the right will turn the interior lights off and will begin to dim the gauge backlighting.

The headlight switch connection on the Painless harness comes with two connectors pre-installed; a black eight pin connector and a black single pin connector. The wires going into these connectors can all be seen in the [Headlight Switch Schematic](#) on the next page. These wires are:

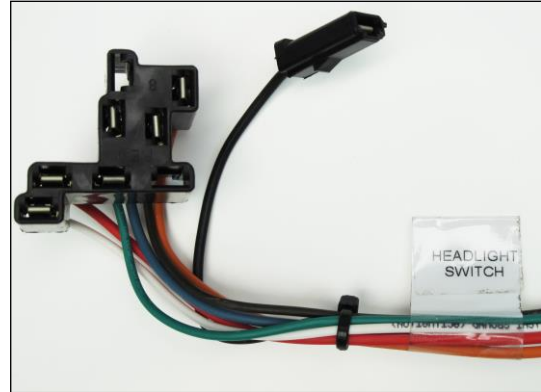

8 pin connector

Orange: 14 gauge wire, printed **#959 HEADLIGHT SWITCH POWER (PARK/TAIL)**, this wire supplies constant battery power for the park/tail lights as well as for the gauge back lighting. This wire comes from the 15 amp PARK/TAIL fuse on the fuse block.

Brown: 16 gauge wire, printed **#927 PARK LIGHT POWER**, this wire supplies power to the park lights and tail lights. This wire will have constant battery power any time the headlight switch knob is pulled out in the both the first and second positions.

Light blue: 14 gauge wire, printed **#907 DIMMER SWITCH POWER**, this wire supplies power to the dimmer switch for headlight operation. This wire will have constant battery power any time the headlight switch knob is pulled out in the second position.

Green: 16 gauge wire, printed **#930 POWER TO GAUGE/PANEL LIGHTS**, this wire provides power to the gauge lights. This wire will have constant battery power any time the headlight switch knob is pulled out in both the first and second positions.

If the knob of the headlight switch is rotated all the way to the right, you will not have power on this wire. If you do not have power to the gauge lights during testing, first check the knob position.

Red: 14 gauge wire, printed **#928 HEADLIGHT SWITCH POWER (HEADLIGHTS)**, this wire provides constant battery power to the headlight switch for headlight operation. This wire comes from the 30 amp HEADLIGHT fuse on the fuse block.

White: 16 gauge wire, printed **#961 DOME LIGHT GROUND (ACTIVATION)**, this wire provides the ground source for interior light activation. This wire will be grounded by the black #969 wire, found in the single pin connector, when the knob is turned all the way to the left. The white #961 is spliced into the door switch/ground wires of all the dome and courtesy lights. This wire can also be seen in the [Courtesy/Dome Light Schematic](#) on page 71.

Wiper Switch

The wiper switch connection is made up by two two pin connectors and three loose open ended wires. All of the wires in the wiper switch section can be seen in the [Wiper Switch Schematic](#) on page 103. These wires are:

Two pin Stacked Connector

Blue: 16 gauge wire, printed **#984 WASHER PUMP GROUND ACTIVATION**, this wire will send a ground signal to the washer pump causing the pump to begin sending fluid to the windshield spray nozzles.

Black: 16 gauge wire, printed **#969 WIPER SWITCH GROUND**, this is the ground source to the wiper switch. This #969 wire is part of the integrated ground circuit of this Painless harness. It can also be seen in the [Ground Schematic](#) on page 15.

Two pin Flat Connector

Light Blue: 16 gauge wire, printed **#979 WIPER SWITCH (LOW)**, this is a ground signal to the low speed tab on the wiper motor.

Black: 16 gauge wire, printed **#977 WIPER SWITCH (HIGH)**, this is a ground signal to the high speed tab on the wiper motor.

Loose, Open Ended Wires

Green: 16 gauge wire, printed **“FOR ALL DELAY SYSTEMS”**, this wire runs to the wiper motor and will be used with both factory delay wiper systems.

White: 16 gauge wire, printed **“FOR 1977-1979 DELAY SYSTEMS”**, this wire will only be used on factory 1977-1979 delay systems and runs to the wiper motor.

Orange: 16 gauge wire, printed **“FOR 1977-1979 DELAY SYSTEMS (POWER)”**, this is a power wire required on factory 1977-1979 delay systems. This wire is a switched ignition power source from the 15 amp WIPER fuse. In most installs this wire will not be used.

The wiper switch connection will vary depending on the year of your Camaro and if you are using a delay/pulse wiper system. When it comes to the connection point there are six different switches, connect the wires of the Wiper Switch section according to one of the following sets of instructions:

1970-1971 Switches

The factory connector for this switch is no longer produced; you can re-use your factory connector or install insulated terminals to make this connection. However the two pin flat connector pre-installed on the Painless harness will fit this connector.

To re-use your factory connector:

- Remove the wires from both pre-installed connectors on the Painless harness as well as the factory harness. Terminal removal instructions can be found in the “Washer Pump” section on page 33 of the Engine Harness manual.
- Re-pin your factory connector with the wires on the Painless harness according to the numbers and instructions following the “1970-1971” photo below. The black #969 will not be needed.

Those without a factory connector:

- Cut the two pin stacked connector from the Painless harness.
- Install an insulated terminal from the parts kit on the **#984** Blue wire. The black **#969** wire will not be used.
- The pre-installed flat connector on the Painless harness will fit this switch so no changes needed to that connector.

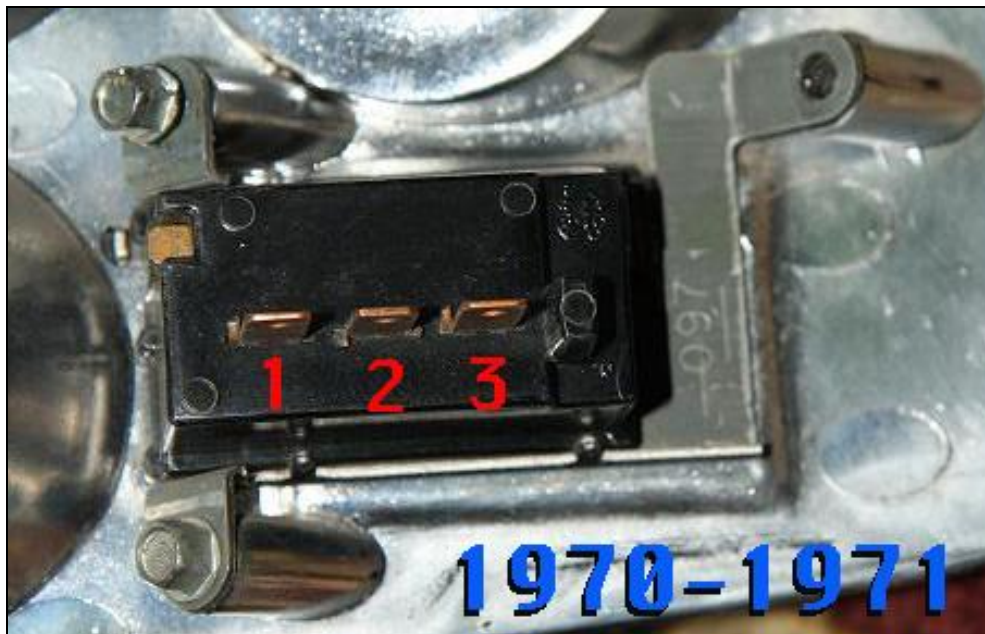

1: Black wire **#977 (HIGH)** **2:** Light Blue wire **#979 (LOW)** **3:** Blue wire **#984 Washer**

1972-1974 Switches

The factory connector for this switch is no longer produced; you can re-use your factory connector or install insulated terminals to make this connection. However the two pin flat connector pre-installed on the Painless harness will fit this connector.

To re-use your factory connector:

- Remove the wires from both pre-installed connectors on the Painless harness as well as the factory harness. Terminal removal instructions can be found under the “Washer Pump” section on page 33 of the Engine Harness manual.

- Re-pin your factory connectors with the wires on the Painless harness according to the numbers and instructions following the “1972-1974” photo below.

Those without a factory connector:

- Cut the two pin stacked connector from the Painless harness.
- Install an insulated terminal from the parts kit on the #984 Blue wire and the #969 Black wire
- The pre-installed flat connector on the Painless harness will fit this switch so no changes needed to that connector.

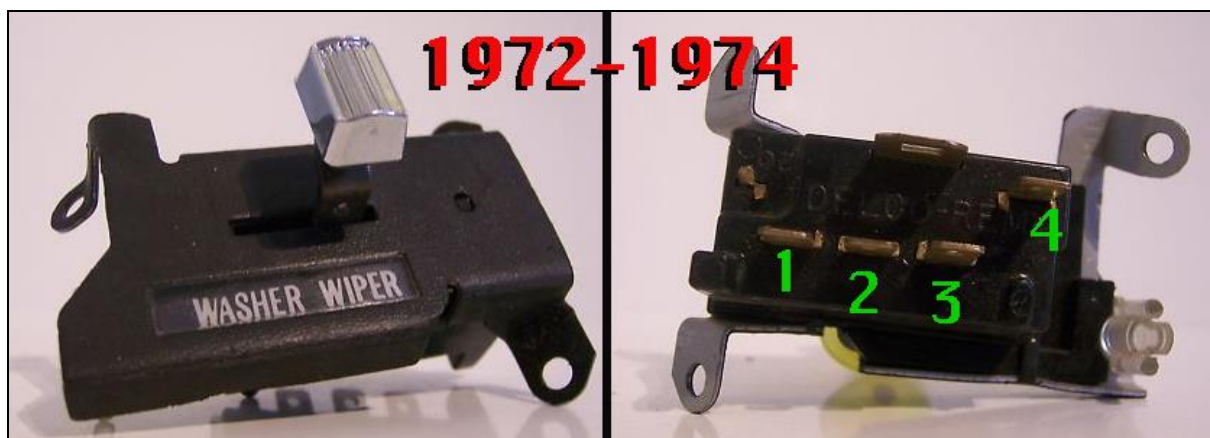

- 1: Black wire #977 (HIGH) 2: Light Blue wire #979 (LOW) 3: Blue wire #984 Washer
4: Black wire #969 GROUND

1975-1978 Switches (Non-Delay and Delay)

The connectors pre-installed on the Painless harness will fit this switch.

- Plug the two pin stacked connector onto the two stacked terminals. The dark blue wire will go towards the center of the switch.
- Plug the flat two pin connector into the bottom two terminals of the wiper switch. There is a plastic keeper that will only allow the connector to plug in one way. If that keeper isn't present make sure the light blue wire of the flat connector is closest to the panel light, as seen in the connection sequence photos.

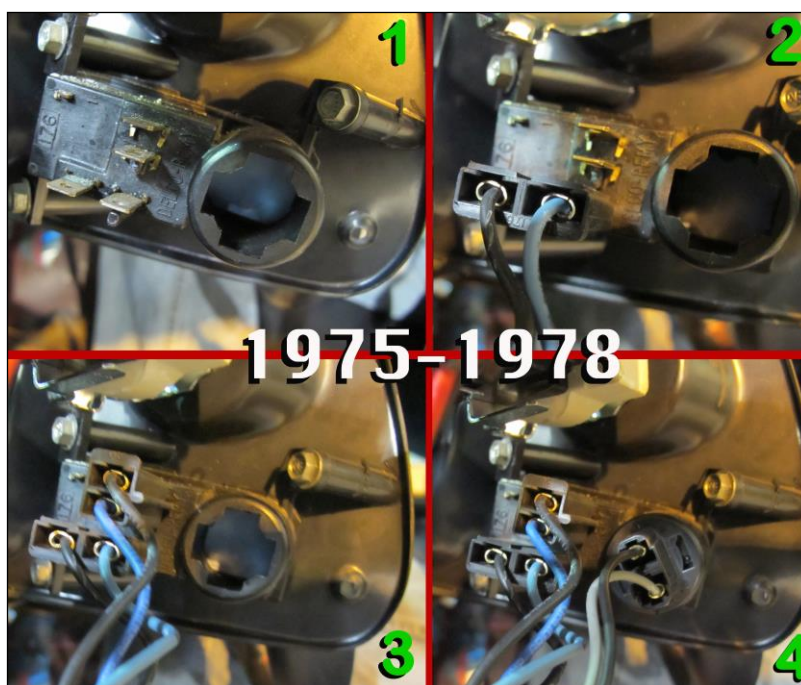

1977 saw the introduction of the intermittent wiper option. This switch will have an additional three wires (green, white, and orange) coming from the back of the wiper switch.

- The three wires coming from the back of this switch will match color for color the three un-terminated wires found on the Painless harness. The factory connector is no longer available so insulated terminals from the parts kit will need to be utilized in order to make these connections.

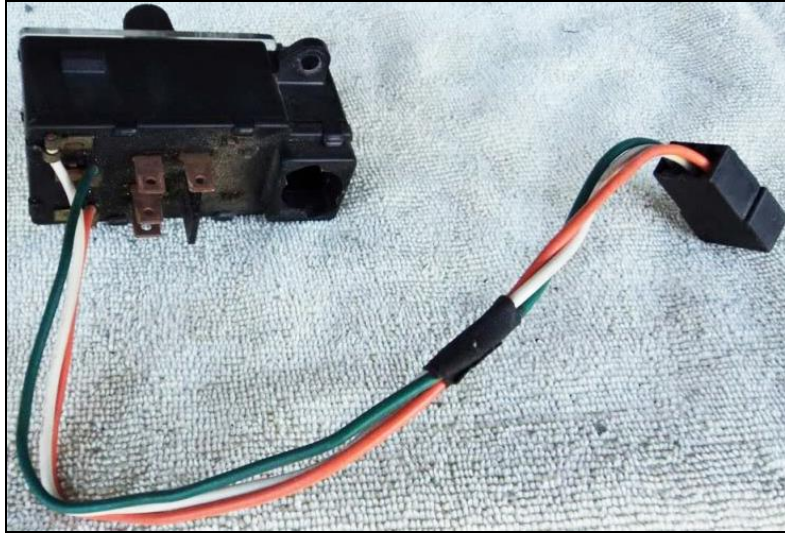

1979-1981 Switches (Non-Delay and Delay)

The connectors pre-installed on the Painless harness will fit this switch.

- Plug the two pin stacked connector onto the two stacked terminals. The dark blue wire will go towards the center of the switch.
- Plug the flat two pin connector into the bottom two terminals of the wiper switch. Make sure the light blue wire of the flat connector is closest to the panel light, as seen in the connection sequence photos to the right.

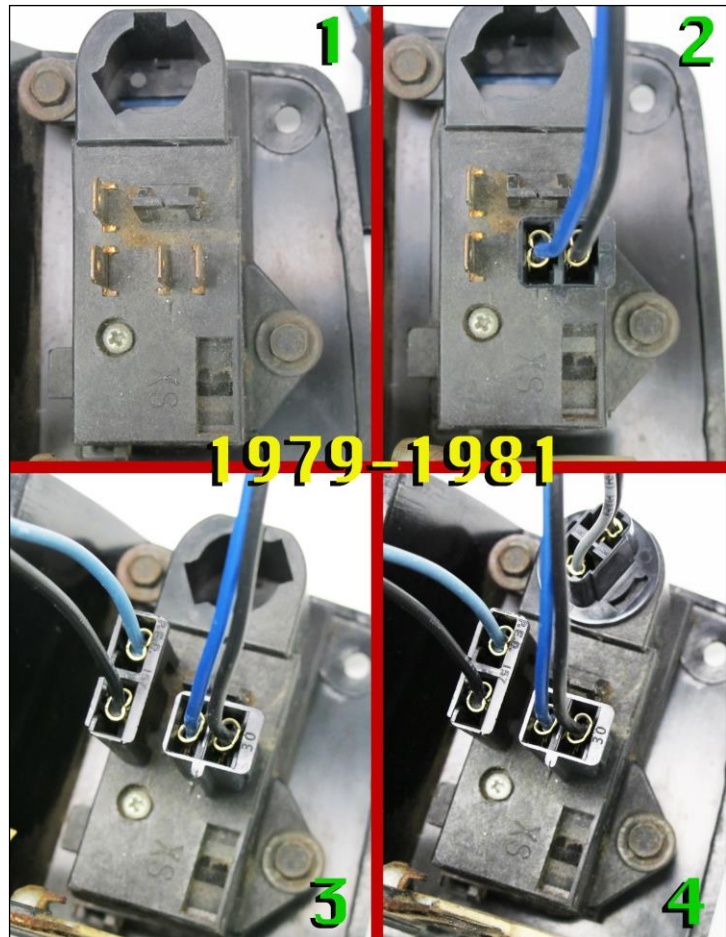

There are two different intermittent switches for the 1979-1981 models; a three wire, seen on the previous page, and a single wire, seen below. The connectors on the Painless harness will connect exactly like the normal two speed switch on both delay switches. Refer to one of the previous pages for connection of the HI, LOW, WASH, and Ground wires according to what year switch you are using.

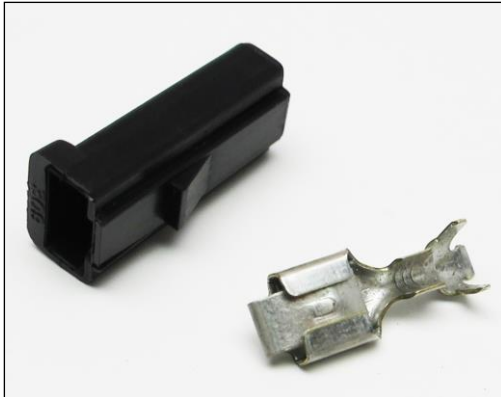

For the single wire delay switches, locate the terminal and connector, seen in the photo to the left, in the parts kit.

- Install the terminal onto the green wire, printed “**FOR ALL DELAY SYSTEMS**”, in the wiper switch section and install the connector.
- This connector will now plug into the wire coming from the switch.

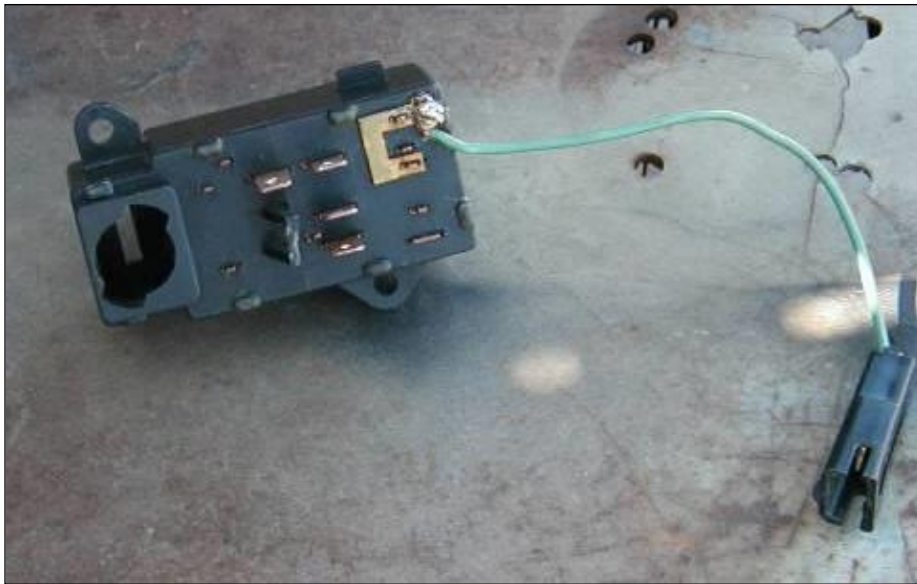

Wiper Switch Panel Light

The final connection on the wiper switch is the panel light. This connection will provide a light source to the wiper switch panel. This light socket receives power from the headlight switch whenever the headlight switch is in the Park Lights ON and in the Headlights ON positions. 1970-1974 Camaros did not have this panel light; those with vehicles in this year range will skip to the next connection.



The panel light connector has a section label reading “PANEL LIGHT”, as seen in the photo. This will be a two pin black connector pre-installed, the wires in the connector will be:

Gray: 18 gauge wire, printed **#930 PANEL LIGHT POWER**. This wire comes from a splice that distributes power from the headlight switch. This splice and the #930 wire can be seen in the [Headlight Switch Schematic](#) on page 97.

Black: 18 gauge wire, printed **#969 PANEL LIGHT GROUND**, this wire provides a ground source for the light and comes from a splice that is tied to the interior ground wire. This panel light ground along with the other interior ground wires and splices, can be seen in the [Ground Schematic](#) on page 15 of the Engine Harness manual.

- Locate the small bulb from the parts kit that fits into the panel light socket. Install this bulb into the socket. This will be a 194 bulb, the same style that is used on the exterior marker lights.
- With the bulb now installed, insert the socket into the panel lamp hole on the back of wiper switch. As seen in the “#4” photos on pages 100 & 101.

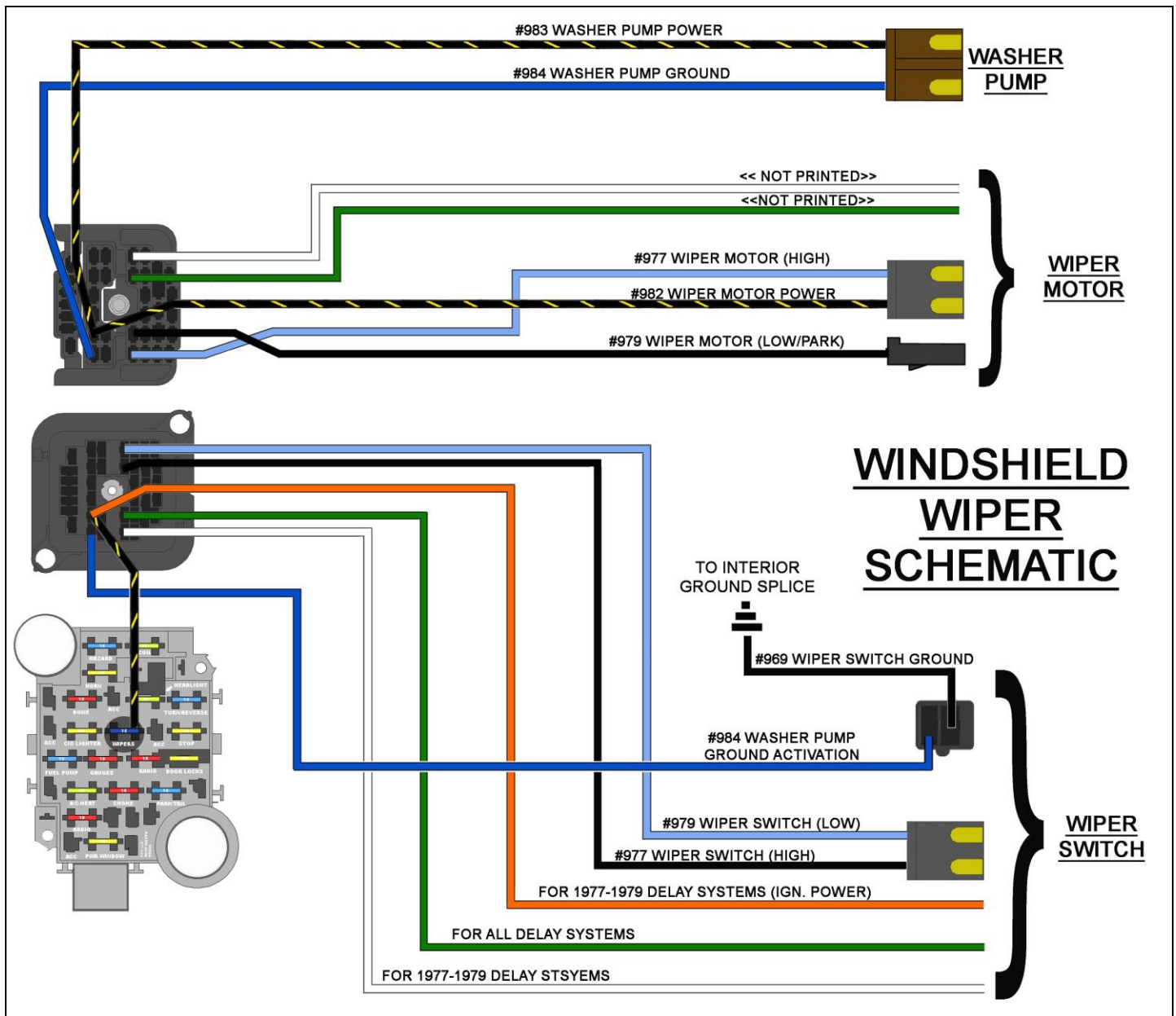

Aftermarket Gauges

An addition to the Painless harness, and not found on a factory harness, is a connection providing all the wires needed for aftermarket electric or mechanical gauges. If you are mounting gauges on the dash below the radio or on the console, this connection will be useful to you as you do not have to trace any wires or run addition wires to for these gauges.



This connection on the Painless harness will consist of an eight pin connector and will have a section label reading "AFTERMARKET GAUGES". The wires in this connector are:

Black: 16 gauge wire, printed **#969 INSTRUMENT CLUSTER GROUND**, this wire provides a ground source. This wire is tied into the integrated ground circuit and can be seen in the [Ground Schematic](#) on page 15.

Gray: 18 gauge wire, printed **#930 GAUGE LIGHT POWER**, this wire will provide a power source for the gauge light(s). The gray #930 is tied to the other #930 wires coming from the headlight switch to things like the radio backlight/dim, panel lights, and gear indicator light. This wire will have power anytime the headlight switch is in the Park/Tail Lights ON or Headlights ON position. This wire can also be seen in the [Headlight Switch Schematic](#) on page 97

Black: 16 gauge wire, printed **#969 GAUGE LIGHT GROUND**, this wire provides a ground source for the gauge light(s). This wire is tied into the integrated ground circuit and can be seen in the [Ground Schematic](#) on page 15.

Pink: 18 gauge wire, printed **#935 GAUGE POWER**, this wire provides a switched ignition power source for any gauges. This wire comes from a splice of a wire that comes from the 10 amp GAUGES fuse on the fuse block. This wire will have power anytime the key is in the ON/RUN position. See the [Gauge Power Schematic](#) on page 95.

Tan: 18 gauge wire, printed **#939 FUEL LEVEL SIGNAL**, this wire is a ground signal from a fuel level sending unit in the fuel tank. The resistance to ground will vary on this wire according to how much fuel is in the tank. This wire can also be seen in the [Tail Harness Ground Schematics](#) on pages 117, 128, and 137.

Green: 18 gauge wire, printed **#921 ENGINE TEMP SIGNAL/TEST**, this wire is a ground signal from the engine coolant sending unit. The resistance to ground will vary on this wire according to engine temperature. This wire can also be seen in the [Ignition Switch Schematic](#) on page 76.

Brown: 18 gauge wire, printed **#923 TACH SIGNAL**, this wire is a ground signal from the negative side of the ignition coil. This wire can also be seen in the coil connection diagrams on pages 39 & 40.

Blue/White: 18 gauge wire, printed **#922 OIL PRESSURE SIGNAL**, this wire is a ground signal from the oil pressure sending unit. The resistance to ground will vary on this wire according to oil pressure.

A mating connector and terminals have been provided to allow connections to be made to gauges without having to hard wire the chassis harness directly to the gauges.

Refer back to the series of diagrams on pages 89-92 to route gauge power/ground and backlighting power/ground from the mating connector to the gauge(s).

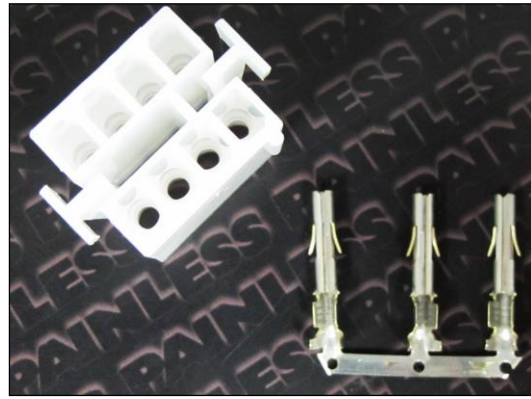

- The included terminals will require a ¼” strip length on the wire they are being applied to, and the use of roll over crimpers, pictured on page 8 of the Engine Harness manual.
- Using the diagram pin out of the supplied connector, plug the wires going to your aftermarket gauges into their corresponding pin location. The terminals will be inserted into the square opening of the connector and the pin locations can be identified by the numbers printed above the round opening of the connector.

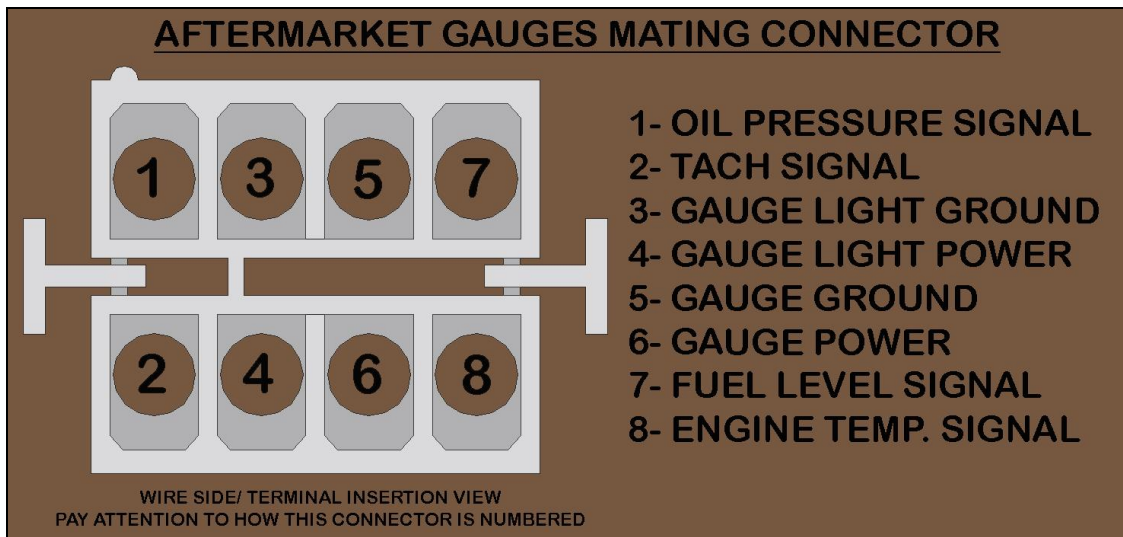

- 1- OIL PRESSURE SIGNAL
- 2- TACH SIGNAL
- 3- GAUGE LIGHT GROUND
- 4- GAUGE LIGHT POWER
- 5- GAUGE GROUND
- 6- GAUGE POWER
- 7- FUEL LEVEL SIGNAL
- 8- ENGINE TEMP. SIGNAL

“Gear Indicator Light”

This connection will provide power and ground to a factory or aftermarket floor mounted automatic shifter with a gear indicator light. There will be two open ended wires with a section label reading “GEAR INDICATOR LIGHT” that are 3’ long coming from the harness. These two wires are:

Gray: 18 gauge wire, printed **#930 GEAR INDICATOR LIGHT POWER**, this wire will provide a power source for the gear indicator light. The gray #930 is tied to the other #930 wires coming from the headlight switch to things like the radio backlight/dim and gauge lights. This wire will have power anytime the headlight switch is in the Park/Tail Lights ON or Headlights ON position. This wire can also be seen in the [Headlight Switch Schematic](#) on page 97.

Black: 18 gauge wire, printed **#969 GEAR INDICATOR LIGHT GROUND**, this wire provides a ground source for the gear indicator light. This wire is tied into the integrated ground circuit and can be seen in the [Ground Schematic](#) on page 15.

- Route these wires to the gear indicator light at the base of the shifter and cut to length. It may be necessary to route these wires under the carpet if a console is not being used.
- Connect the wires to the gear indicator light by splicing the wires to the original light housing or to the wires coming off your aftermarket shifter.

“Courtesy Light”

This connection will allow the under dash/foot well area of the passenger side of the vehicle to be illuminated any time a door is open or when the headlight switch is activating the dome light. Your vehicle may or may not have had them from the factory; that will not affect these working properly as they have been pre-wired into the Painless harness.

This connection will have a section label reading “COURTESY LIGHT”. It will be a large gray colored lamps socket with two wires pre-wired to it, these wire are:



Orange: 18 gauge wire, printed **#971 COURTESY LIGHT POWER**. This power wire is spliced to the wires going to the driver side courtesy light, the glove box light, and to a wire that comes from the 10 amp DOME fuse on the fuse block; this fuse has battery power and is hot at all times. This wire can be seen in the [Courtesy/Dome Light Schematic](#) on page 71.

White: 18 gauge wire, printed **#961 COURTESY LIGHT GROUND**. This wire is the ground wire that activates the courtesy light. When this wire is grounded it completes the voltage path causing the light to illuminate. This ground will come from either the door jamb switch or the headlight switch. This wire is splices to wires going to these components and can be seen in the [Courtesy/Dome Light Schematic](#) on page 71.

This light socket uses a 67 series bulb; a 67 series bulb has been pre-installed into the socket.

- Route the socket to a suitable mounting location under the dash. The light socket has a small hole in a mounting tab to allow mounting. Self tapping screws have been provided as a mounting solution. Small zip ties, provided with this kit, may also come in handy if a suitable location for the light socket cannot accommodate mounting with a screw.

“Seat Belt Light”

The seat belt light will only be found on 1973 and up vehicles, as indicated by the photo below. Those with 1970-1972 dashes and those who did not install a working seat belt relay-buzzer on page 61 will skip to the next connection.

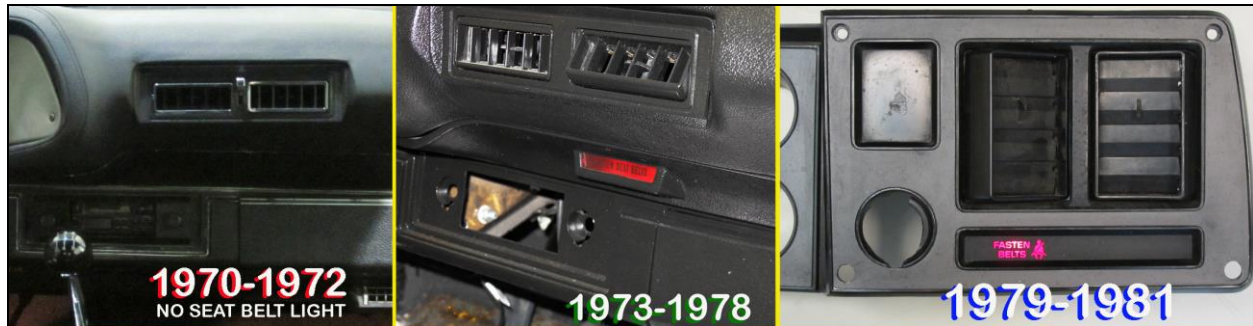

The seat belt light is an indicator found close the center of the dash. This light will activate when the ignition switch is turned to the ON position. If the seat belt relay is working properly this light will come on for 4-8 seconds and then turn off. This light will come on regardless if the seat belt is plugged in or not.

The seatbelt light connection on the Painless harness will be a light socket with a label reading “SEAT BELT LIGHT”. This socket will have two wires going to it, these wires are:

Pink/White: 18 gauge wire, printed **#942 SEAT BELT LIGHT POWER/ACTIVATION**, this wire comes from the seat relay relay/buzzer. The relay switches power to this wire to activate the light.

Black: 18 gauge wire, printed **#969 SEAT BELT LIGHT GROUND**, this wire provides a ground source for the seat belt light. This wire is tied into the integrated ground circuit and can be seen in the [Ground Schematic](#) on page 15.



- Locate the small bulb from the parts kit that fits into the panel light socket, seen in the photo to the left. Install this bulb into the socket. This will be a 194 bulb, the same style that is used on the exterior marker lights.
- With the bulb now installed, insert the socket into the panel lamp hole on the back of wiper switch.

If the socket does not turn to lock in place, it may be necessary to gently pry the tab on the socket up towards the bulb for clearance, shown in the photo.

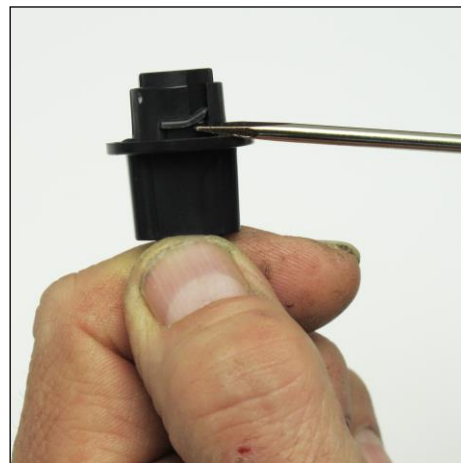

The next two connections pertain to the glove box light. If your Camaro does not have this option, skip to the passenger side door jamb switch on the next page.

Glove Box Switch



The glove box switch connection will activate the glove box anytime the glove box door is open. This switch acts just like the driver and passenger door jamb switches as this switch provides a ground source from the switch to the light mounted on top of the glove box..

The glove box switch will only require one wire from the Painless chassis harness; there will be another wire hard wired from the switch to the glove box light. This wire from the switch to the light is not in the Painless harness as it is a component that is part of the switch and light. This hard wired wire can be seen in the photo at the top of the next page.

The wire found on the Painless harness will have a single pin black connector pre-installed, with a section label reading "GLOVE BOX SWITCH", this wire is:

Black: 18 gauge wire, printed **#969 GLOVE BOX SWITCH GROUND**, this wire provides a ground source to the switch. This wire is tied into the integrated ground circuit and can be seen in the [Ground Schematic](#) on page 15.

- Route this connector to the glove box switch connector, seen below and in the picture at the top of the next page, and connect.

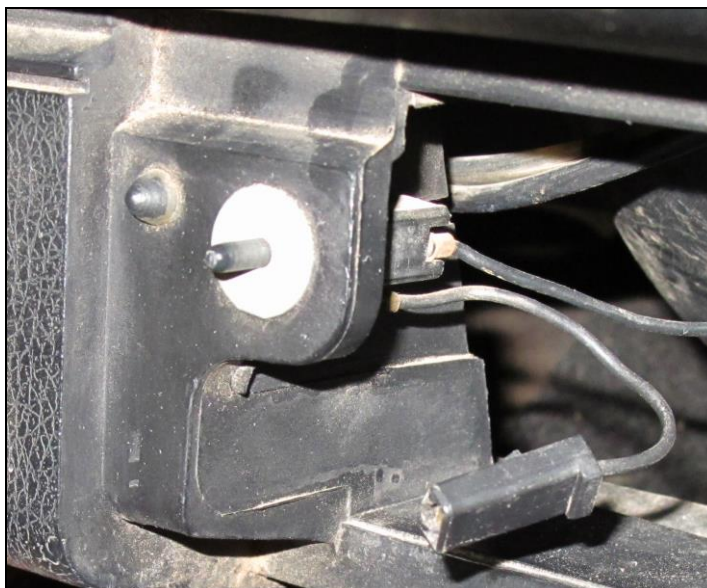

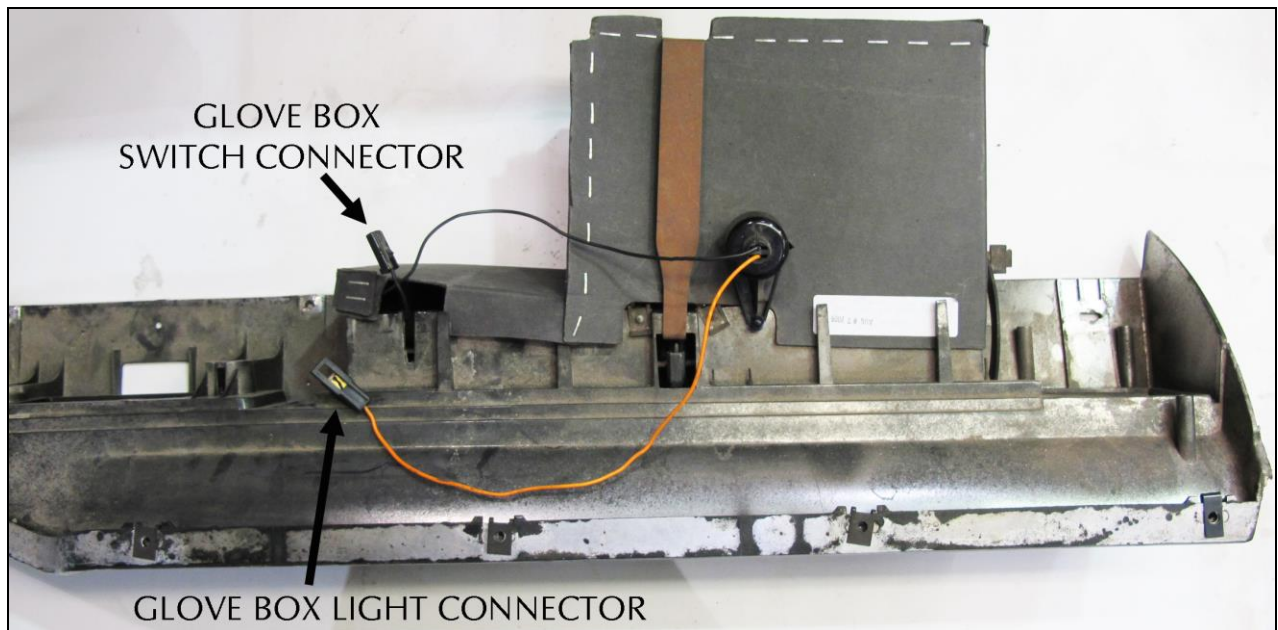

Glove Box Light

The glove box light will only require a one wire connection as the other wire from the light is already connected as it is part of the glove box switch as described in the previous connection.

The wire found on the Painless harness will have a single pin black connector pre-installed, with a section label reading "GLOVE BOX LIGHT", this wire is:

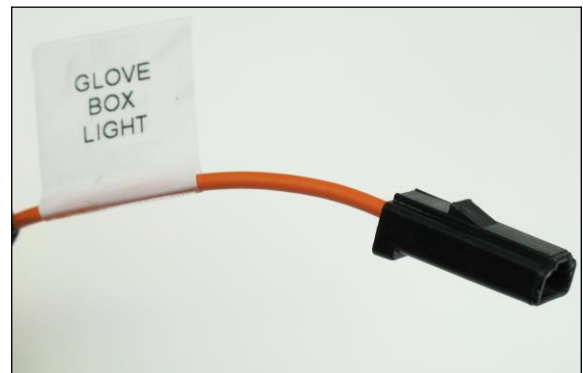

Orange: 18 gauge, printed **#971 GLOVE BOX LIGHT POWER**. This power wire is spliced to the wires going to the courtesy lights, the dome light, and to a wire that comes from the 10 amp DOME fuse on the fuse block; this fuse has battery power and is hot at all times. This wire can be seen in the [Courtesy/Dome Light Schematic](#) on page 71.

- Route this connector to the glove box light connector seen in the large photo at the top of the page and connect.

"Passenger Side Door Jamb Switch"

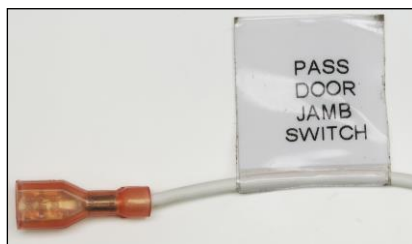

The passenger side door jamb switch will be the last connection in the dash group of wires. You should have previously installed the new door jamb switch provided with your Painless harness, page 62. Information on how the door jamb switch functions can also be found in the same section.

The passenger side door jamb switch will be a one wire connection with a small insulated terminal pre-installed; a section label reading "PASS DOOR JAMB SWITCH" will be found on this wire. This wire will be:

White: 16 gauge, printed #961 PASS. DOOR JAMB SWITCH, this wire will provide a ground source from the jamb switch to the courtesy lights and the dome light. This ground will activate the lights, causing them to illuminate when the door is open. This wire can be seen in the [Courtesy/Dome Light Schematic](#) on page 71.

- Route this white #961 wire to the passenger side door jamb switch and connect.

TAIL SECTION of the MAIN HARNESS

In order to properly route and connect the tail section, it is recommended that the driver side kick panel, door sill plate, and driver side rear interior panel be removed. This will allow plenty of access to properly install this section of the Painless harness.

- Begin by loosely routing the tail section from the fuse block, to the left of the dimmer switch and along the area where the driver kick panel mounts, and into the door sill channel.

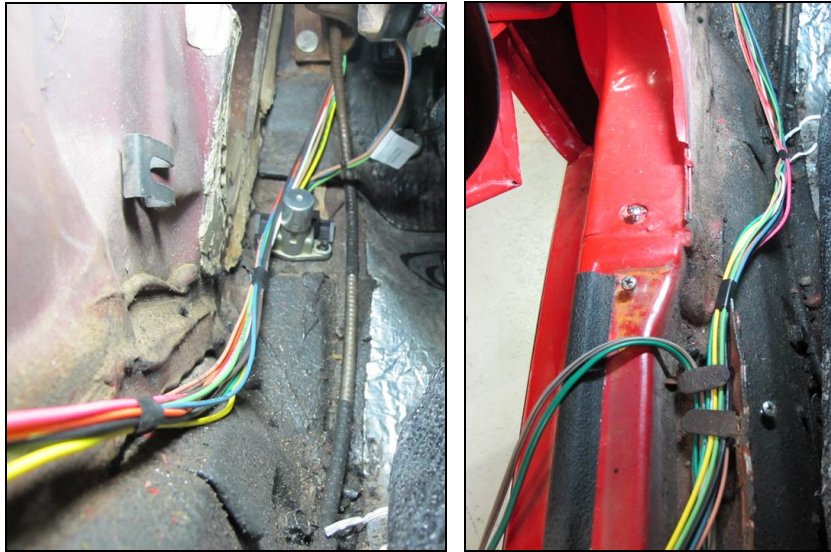

- Once in the door sill channel, fold down or route the harness under the straps to secure, seen in photo above/right. Finish routing the harness down the length of the channel to the back seat area.

The seat belt connection will break out from the harness channel and will not be routed to the back seat. Installs not utilizing a seatbelt light on the dash can simply zip tie the seat belt connection to the rest of the tail harness.

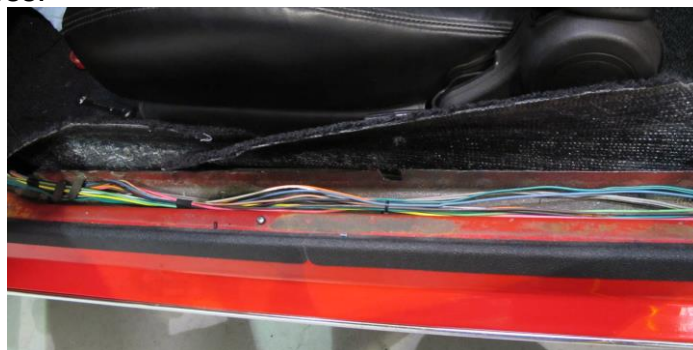

*the photo above was of a 1970, the seat belt connection was omitted

- Now that the tail section is in the back seat area, route the harness over the wheel tub, securing the harness with the factory installed clips. The looped green wire you see in the photo is the wire for the rear speaker; it is NOT included with the Painless harness.

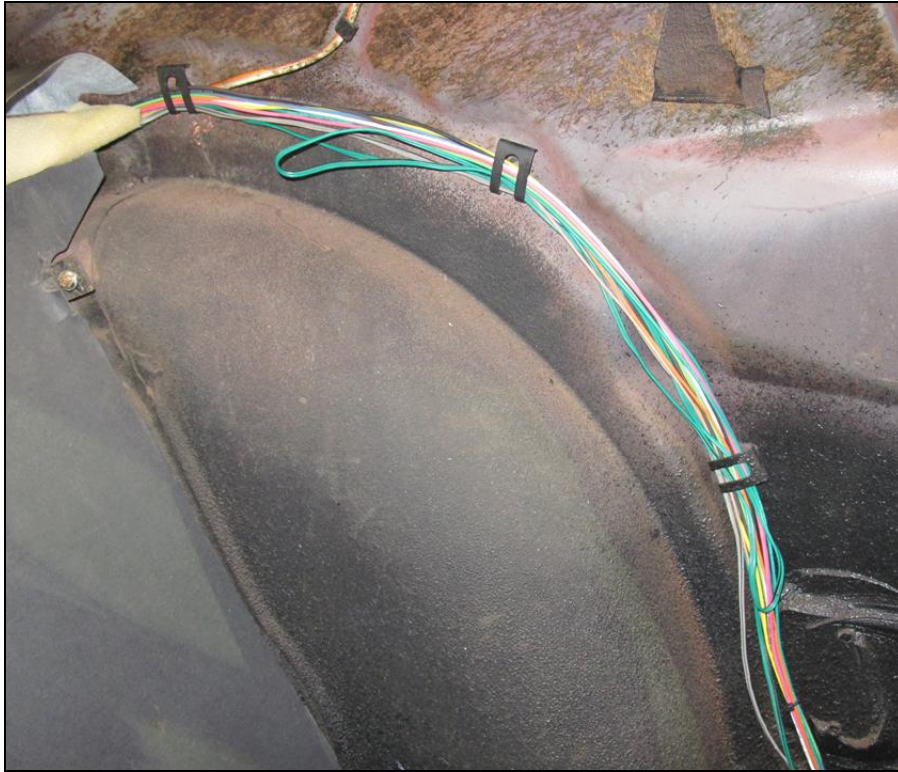

- With the harness now secured in the clips, route the tail section of the harness through the hole in the package tray to the trunk.

Some may opt to leave the dome light wires in the back seat area for easier connection since the dome light wires are visible, seen top/center in the photo above. This dome light connection will be handled on the next page.



“Seat Belt Ground”

This connection is intended for the seat belt ground on the driver seat. When the seat belt is connected it will complete a ground circuit, sending a ground signal to the seatbelt buzzer-relay. This ground signal will deactivate the seat belt buzzer if the seatbelt has been connected prior to turning the key in the ignition switch to the ON/RUN position.

These wires will have a section label reading “SEAT BELT”. There will be a two pin black connector with two wires. These wires are:

Black: 18 gauge wire, printed **#993 SEAT BELT GROUND SIGNAL**, this wire will send a ground signal to the seatbelt buzzer-relay to disable the buzzer.

Black: 18 gauge wire, printed **#969 SEAT BELT GROUND**, this wire will provide a chassis ground source to the seat belt.

- Route the #993 and #969 wires underneath the carpet to the base of the driver’s seat belt buckle near the console/transmission tunnel.
- At the base of the seat belt buckle you will notice a two pin black connector with two wires leading up to the buckle, plug the connector found on the Painless harness into this connector.

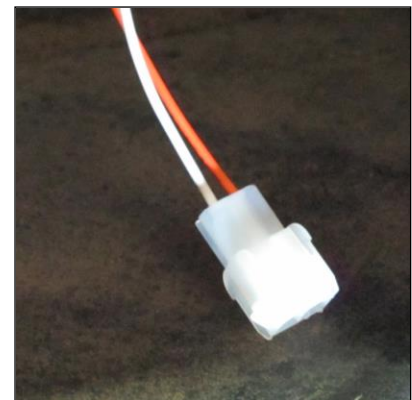

“Dome Light”

The dome light has constant battery applied to it. This light, along with the under dash courtesy lights, is ground activated by the door jamb switches and also by turning the headlamp knob counter clockwise.

The two wires of the Painless harness designated for dome light connections will have a section label reading “DOME LIGHT”. These two wires will have a two pin white connector pre-installed. These wires are:

Orange: 18 gauge wire, printed **#971 DOME LIGHT POWER**. This power wire comes from the 10 amp DOME fuse on the fuse block; this fuse has battery power and is hot at all times. This wire can be seen in the [Courtesy/Dome Light Schematic](#) on page 71.

White: 18 gauge wire, printed **#961 DOME LIGHT GROUND**. This wire is the ground wire that activates the dome light. When this wire is grounded it completes the voltage path causing the light to illuminate. This ground will come from either door jamb switch or the headlight switch. This wire can be seen in the [Courtesy/Dome Light Schematic](#) on page 71.

The factory wires coming from the dome light will need to have the supplied 2 pin connector and terminals, found in the parts kit, installed in order for the Painless harness to make a connection. You can either cut the factory dome light wires on the interior of the car, as indicated on page 111, or you can remove the original connection in the trunk, the choice is up to the installer.

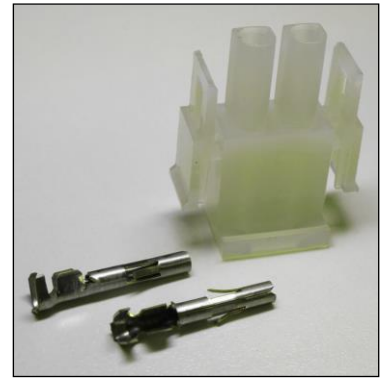

- Begin by cutting the factory dome light wires and stripping $\frac{1}{4}$ " of insulation from each wire.
- Locate the terminals and connector seen in the photo above.
- Using roll over crimpers, like shown on page 10, crimp a terminal onto each of the factory dome light wires.
- Insert each terminal into the connector, white wire to pin 1 & orange wire to pin 2. If your wires are not color coded (like those shown below) or if you accidentally incorrectly pin out the connector, do not worry, the dome light will work regardless of which wire goes where.
- Once the connector has been installed onto the factory dome light wires, the connector pre-installed on the Painless harness can now be connected to the factory dome light wires, completing this connection.

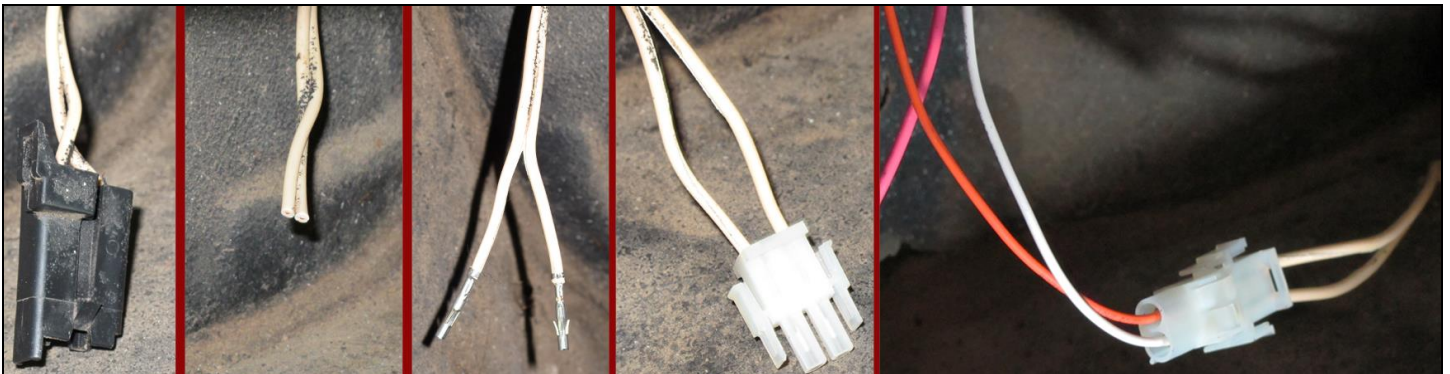

"Fuel Pump"

In the tail section of the harness you will find a wire to provide power to an electric fuel pump. This fuel pump wire can be pulled from the Tail Section of the harness and routed through the firewall depending on where you have the fuel pump mounted. The wire for the fuel pump will be a single open ended wire, it is:



Pink: 14 gauge wire, printed **#947 FUEL PUMP POWER**, this wire will provide a power source to the fuel pump. This wire comes from the 15 amp "FUEL PUMP" fuse on the fuse block and will only have power when the ignition switch is in the ON/RUN position and the START position.

- If a mechanical pump is being used, insulate the end of this wire with an insulated terminal from the parts kit and tape the wire up into the harness and proceed to the next connection.
- If an electric fuel pump is being used, route the pink **#947** wire to the power or + post/tab/wire of the fuel pump. Several different small grommets have been provided in the parts kit to allow you to *drill a hole through the floor pan or firewall to make this connection easier.

*Note: **If a hole in to be drilled in the trunk pan, be sure to not puncture the fuel tank.** Also before a hole is drilled make sure there is no other way to get the #947 wire to the fuel pump. In most cases it can exit the interior of the car with the sending unit wire found in the tail harness. 1978-1981 cars, it can exit through the tail panel with the tail light harness.

- Using an insulated terminal that matches the connection your pump requires, connect the #947 wire to the power or + post/tab/wire of the fuel pump.
- At this time you will need to provide a ground wire. This harness does not provide a ground wire for this component, but a ground can be easily connected using insulated terminals from the parts kit and a length of scrap wire created during a previous connection.

“Tail Harness Connectors”

The last connections of the main harness of the Painless harness are for the Tail Harness. These connections will be 2 Weather-Pac connectors, a 4 pin and a 3 pin. These connectors will connect the main Painless harness to the supplied tail harness. The wires going into these connectors are:

3 pin connector

Yellow- 16 gauge wire, printed **#949 REAR LEFT TURN SIGNAL POWER**, this wire provides power to the left turn signal. This wire will have power anytime the turn signal is in the down position and the ignition switch is in the *ON/RUN* position or anytime the hazard switch is activated. 1970-1977 vehicles, this wire is also the brake light power and will also have power anytime the brake pedal is pressed. This wire can be seen in the [Turn Signal Schematic](#) on page 78.

Green- 16 gauge wire, printed **#948 REAR RIGHT TURN SIGNAL POWER**, this wire provides power to the left turn signal. This wire will have power anytime the turn signal is in the up position and the ignition switch is in the *ON/RUN* position or anytime the hazard switch is activated. 1970-1977 vehicles, this wire is also the brake light power and will also have power anytime the brake pedal is pressed. This wire can be seen in the [Turn Signal Schematic](#) on page 78.

Light Blue- 16 gauge wire, printed **#918 BRAKE LIGHT POWER**, this wire provides power to the brake lights on 1978-1981 and will have power anytime the brake pedal is pressed.

4 pin connector

Tan- 18 gauge wire, printed **#939 Fuel Level Sending Unit**, this wire will send a ground signal from the fuel level sending unit to wires for the fuel gauge at the gauge cluster and aftermarket gauge connector.

Black- 14 gauge wire, printed **#969 GROUND SUPPLY TO REAR LIGHTS**, this wire provides a ground source for the rear lights and comes from a splice that is tied to a series of other splices that ties all the grounds in this harness together. This wire, along with all the other ground wires and splices, can be seen in the [Ground Schematic](#) on page 15.

Brown- 16 gauge wire, printed **#927 TAIL LIGHT POWER**, this wire will provide the tail lights and rear side marker lights power. This wire receives power from the headlight switch and will have power anytime the headlight switch is pulled into the first or second positions. This wire can be seen in the [Headlight Switch Schematic](#) on page 97.

Light Green- 16 gauge wire, printed **#956 REVERSE LIGHT POWER**, this wire will provide power to the reverse or back up lights. This wire receives power from the reverse switch and will have power anytime the shifter is in the *REVERSE* position.

- Route these two connectors towards the tail panel of the vehicle. Connection of these two connectors will depend on the year of your vehicle; at this time proceed to the instructions for the year of your vehicle.

1970-1973: next page

1974-1977: page 127

1978-1981: page 136

1970-1973 TAIL HARNESS INSTALLATION



You will also notice that the wires found on the tail harness are not printed with wire information; this is because all wires go into connectors so no individual connections are really needed. Page 114&115 lists a circuit number for each wire found in the Tail harness based on the wire color. Diagrams of the wires found in the Tail harness can be seen on the next page.

- Begin by examining the section label on the supplied tail harness to ensure you have the correct tail harness for your application. The section label should read "1970-1973".



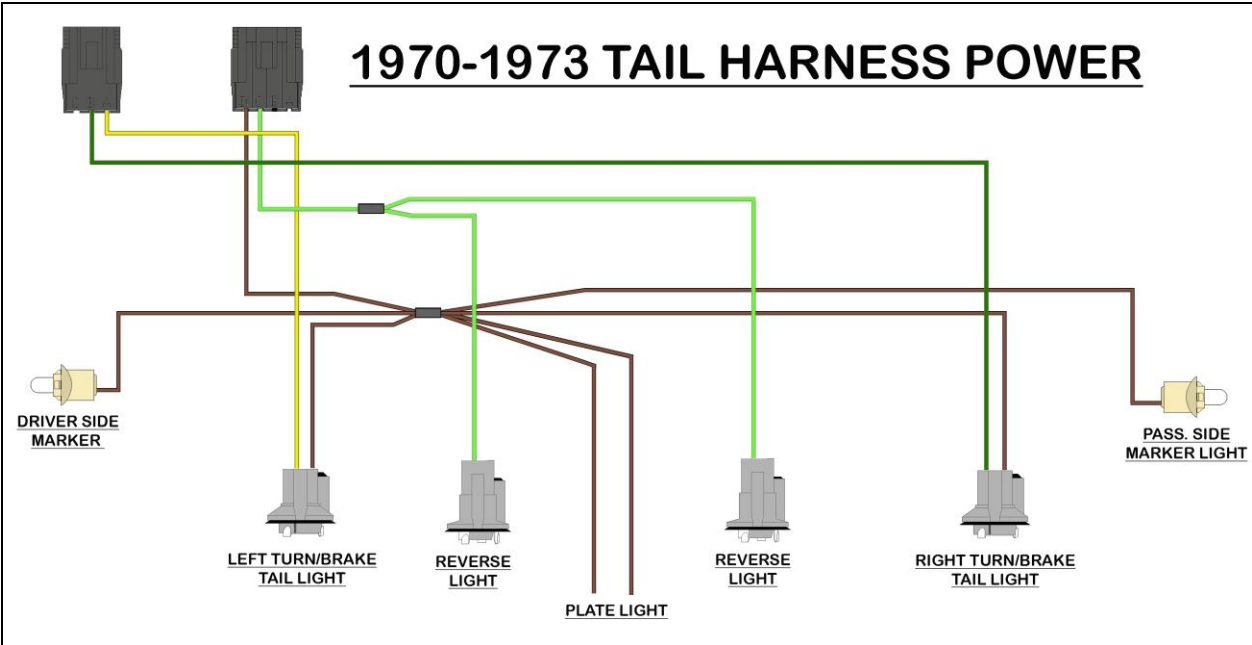
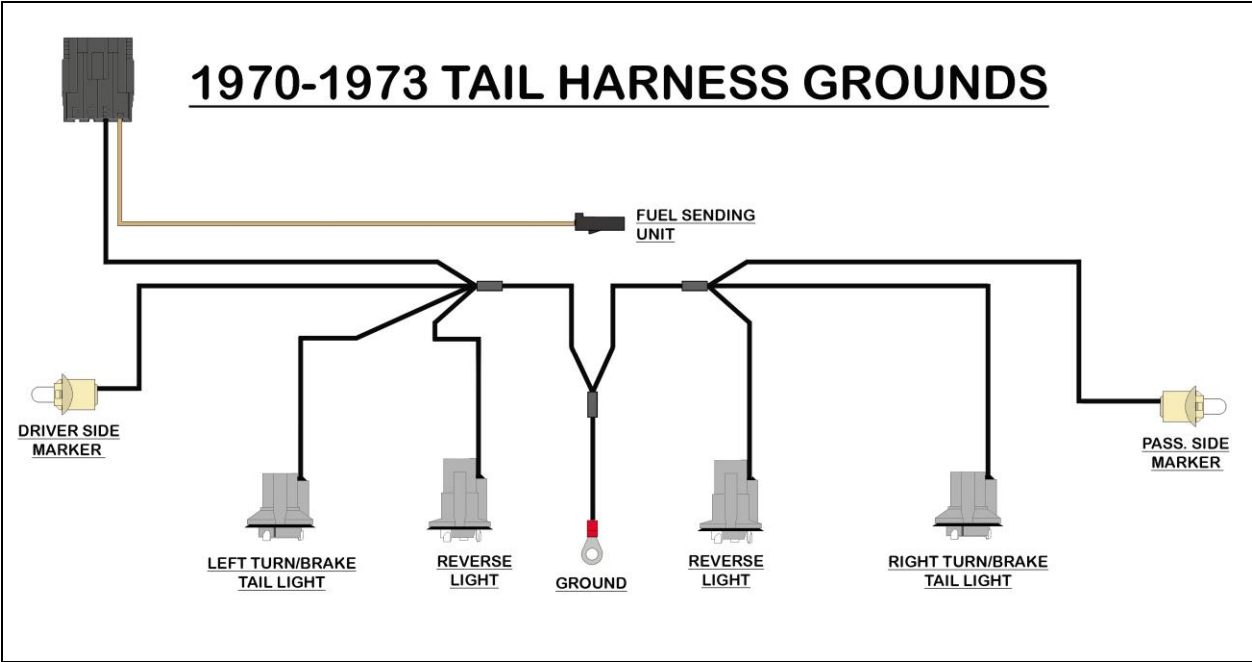

- Begin the installation by plugging the Tail Harness into the two connectors found on the tail section of the main harness. Once connected these connectors can be tucked out of sight, down into the rear quarter.

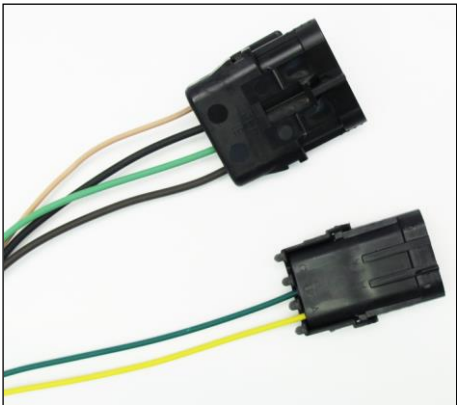
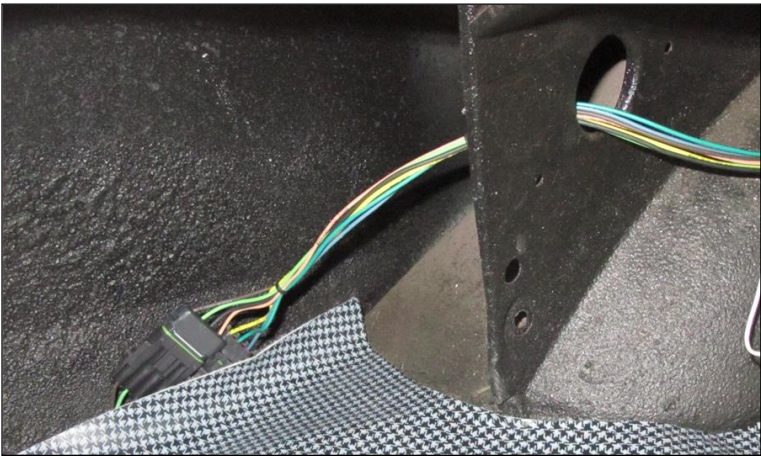

“Driver Side Park Light”

The driver side mounted park light is the next connection. The park, or marker light as it is often called, is activated by a power source coming from the headlight switch. This light will illuminate any time the headlight switch is in the *PARK* or *ON* position.

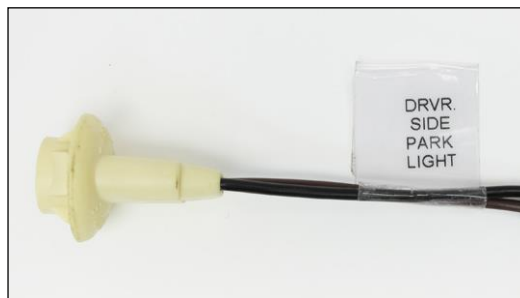

The park light requires two wires to work properly. A factory style socket comes pre-installed and will have a label reading “DRVR. SIDE PARK LIGHT”. The wires spliced to this molded connector are:

Brown: 18 gauge wire, not printed, this is a power wire for the park or marker light function. This wire will have power anytime the headlight switch is in the Park/Tail Lights ON or Headlights ON position. This wire, along with all the other wires and splice it is associated with, can be seen in the [1970-1973 Tail Harness Power](#) diagram on page 117.

Black: 18 gauge wire, not printed, this wire provides a ground source for the park light and comes from a splice that is tied to a series of other splices that ties all the grounds in this harness together. This wire, along with all the other ground wires and splices, can be seen in the [1970-1973 Tail Harness Grounds](#) diagram on page 117.

- Begin by installing the correct bulb, included with the harness, into the socket. This will be a 194 bulb.
- Looking at the back of the park light housing you will see that it has a keyed opening to correspond with the tabs on the socket. (as seen in the photo)



- Insert the lamp socket of the Painless harness into the park light housing and turn ¼ turn to lock the socket in place.

At this time the Tail Harness can be routed.

- Route the breakout with the Left Turn/Brake/Tail Socket and Reverse socket to the driver’s side lens buckets.
- The remainder of the Tail harness will route above the lens buckets and be held in place by the tabs on the body, seen in the picture to the right.



- Route the passenger side of the Tail Harness along the top and through the bracket holding the trunk latch. Partial disassembly of the trunk latch and removal of the plate light lenses may be necessary to pass the passenger side tail light and reverse light sockets through.
- The remainder of the harness will route above the passenger tail light buckets, into the factory harness retainer tab and down to the tail bucket to the right side marker light.



“Left Turn/Brake/Tail Light”

The lens closest to the quarter panel will be for the Left Turn/Brake/Tail Light. This connection will have a section label reading “L. TURN/BRAKE TAIL LIGHT” and a three wire socket pre-installed. The three wires found in this socket are:

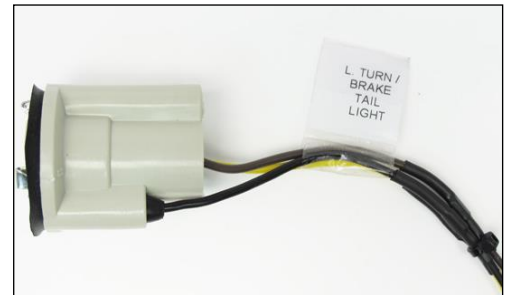

Yellow- 18 gauge wire, not printed, this wire is the turn signal power as well as the brake light power. This wire will have interrupted switched power from the turn flasher any time the left turn signal is activated and interrupted battery power from the hazard flasher any time the hazard switch is in the ON position. This wire will also have battery power anytime the brake pedal is pressed. This wire can be seen in the [1970-1973 Tail Harness Power](#) diagram on page 117.

Brown: 18 gauge wire, not printed, this is a power wire for the tail light function. This wire will have power anytime the headlight switch is in the Park/Tail Lights ON or Headlights ON position. This wire, along with all the other wires and splices it is associated with, can be seen in the [1970-1973 Tail Harness Power](#) diagram on page 117.

Black: 18 gauge wire, not printed, this wire provides a ground source for the Turn/Brake/Tail Light and comes from a splice that is tied to a series of other splices that ties all the grounds in this harness together. This wire, along with all the other ground wires and splices, can be seen in the [1970-1973 Tail Harness Grounds](#) diagram on page 117.

- Insert a bulb from the parts kit into the socket. This socket requires a dual filament bulb, while supplied in the kit, it can also be purchased from just about any auto parts store under part # 1157. The turn signal will be the brighter of the two filaments.
- With the bulb in place, insert the socket into the bottom of the lens. Tuning the socket ¼ turn will lock it in place. Notice the keying on the bucket and the socket will only allow the socket to be installed one way. This connection, along with the next connection, may be easier to make if the lens bucket is removed from the car.



“Reverse Light”

This will be the lens closest to the center of the car, lens with the clear center. This connection will have a section label reading “LEFT REVERSE LIGHT” and will have a two wire socket pre-installed. The two wires in this socket are:

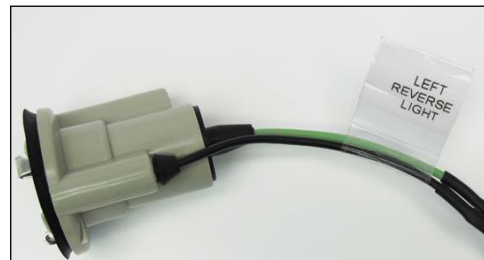

Light Green- 18 gauge wire, not printed, this wire will provide power to the reverse or back up lights. This wire receives power from the reverse switch and will have power anytime the shifter is in the *REVERSE* position. This wire can be seen in the [1970-1973 Tail Harness Power](#) diagram on page 117.

Black: 18 gauge wire, not printed, this wire provides a ground source for the reverse light and comes from a splice that is tied to a series of other splices that ties all the grounds in this harness together. This wire, along with all the other ground wires and splices, can be seen in the [1970-1973 Tail Harness Grounds](#) diagram on page 117.

- Insert a bulb from the parts kit into the socket. This socket requires a single filament bulb, while supplied in the kit, it can also be purchased from just about any auto parts store under part # 1156.

- With the bulb in place, insert the socket into the bottom of the lens. Turning the socket ¼ turn will lock it in place. Notice the keying on the bucket and the socket will only allow the socket to be installed one way.

“Fuel Sending Unit”

The fuel sending unit connection will be a one wire connection. This wire will send a resisted ground source from the fuel level sending unit inside the fuel tank, up to the fuel gauge on the dash. This resistance is based off how much fuel remains in the tank, which causes the needle on the gauge to move between empty and full.

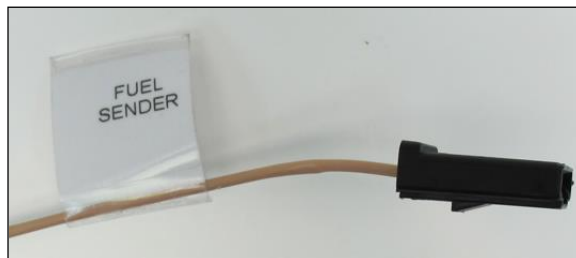

The wire provided in the Tail Harness will have a section label reading “FUEL SENDER”. This wire will have a single pin black connector pre-installed, this wire is:

Tan: 18 gauge wire, not printed, this wire will a ground signal. It can be seen in the [1970-1973 Tail Harness Grounds](#) diagram on page 117.

- Locate the factory wire coming through the trunk floor, just below the trunk latch. Connect the single pin connector and wire found on the Tail Harness to this factory wire, as seen in the photo below.

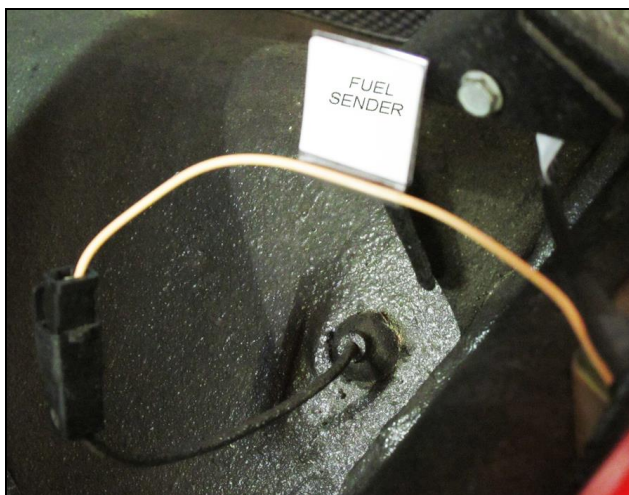

“Ground”

The ground connection in the Tail Harness will tie all of the grounds found in the Tail harness to a common ground source.

One wire, marked with a section label reading “GROUND”, makes up this connection. This wire will have a pre-installed ring terminal, this wire is:

Black: 10 gauge wire, not printed, this wire provides a ground source for the Tail harness from a splice that is tied to a series of other splices that ties all the grounds in this harness together. This wire, along with all the other ground wires and splices, can be seen in the [1970-1973 Tail Harness Grounds](#) diagram on page 117.

- Connect this black ground wire to a good clean chassis ground source, such as one of the mounting bolts for the license plate lens or the trunk latch.



“License Plate Lights”

The plate lights are the next connection needing to be made. These lights are tied to the rear marker lights and will illuminate the license plate during low light conditions when the headlight switch is in the park light “ON” or headlight “ON” positions.

There are two wires found in the Tail Harness to accommodate both license plate lights. The lights only require one wire as the light sockets ground themselves through the housing. The wires in the Painless harness for this function will have labels reading “PLATE LIGHT”. These two wires are:

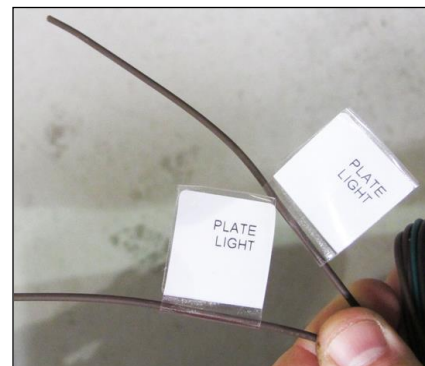

Brown: 18 gauge wires, not printed, these are power wires for the license plate light function. These wires will have power anytime the headlight switch is in the Park/Tail Lights ON or Headlights ON position. This wire, along with all the other wires and splices it is associated with, can be seen in the [1970-1973 Tail Harness Power](#) diagram on page 117.

At the time of this production, factory license plate sockets cannot be sourced for production. You must install your original sockets on the Painless harness using the included bulb contacts.

- Locate the small copper bulb contacts in the parts kit. There have been four included to allow two extra in case of a bad crimp on the first try. Seen in the parts photo on the next page.
- Begin my cutting the wires going to the factory plate light sockets, **use caution.** Once cut, there will be loose pieces that are vital to the proper function of the sockets.

- The three parts you need from the factory assemblies are: the plastic retainer, the spring, and the socket, all seen below.

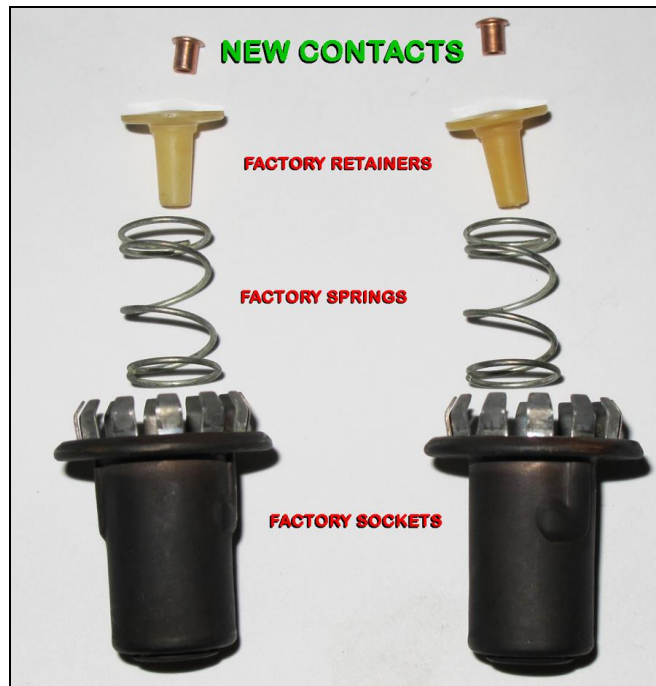

- Locate the two brown wires on the Tail Harness with section labels reading "PLATE LIGHT" and strip 1/8" - 3/16" of insulation.
- Install the parts onto one of the plate light wires in this specific order: the factory socket, the factory spring and then the factory retainer.
- With all three factory components installed, place the new copper contact supplied with the kit onto the un-insulated end of the wire, and crimp. The crimpers needed for this bulb contact are the same crimpers you would use on insulated terminals or splices, like the red handled ones to shown on page 10.



- Install a small bulb from the parts kit into each socket. These bulbs are known as 67 series bulbs and can be purchased at just about any place auto parts are sold.
- Install the plate light sockets into the plate light lenses

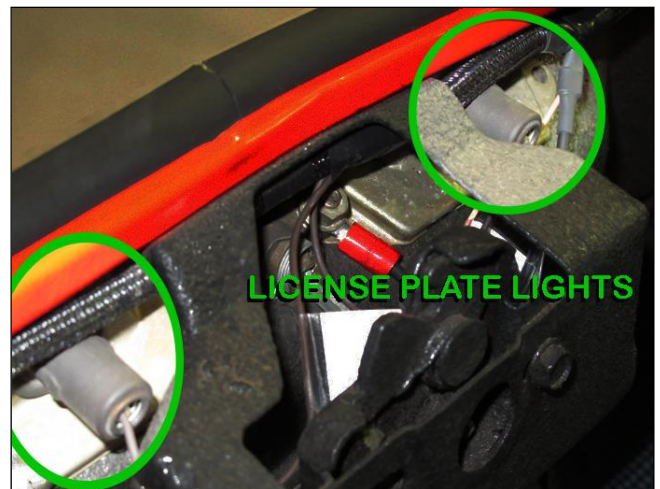

“Right Turn/Brake/Tail Light”



The lens closest to the passenger side quarter panel will be for the right Turn/Brake/Tail Light. This connection will have a section label reading “R. TURN/BRAKE TAIL LIGHT” and a three wire socket pre-installed. The three wires found in this socket are:

Green- 18 gauge wire, not printed, this wire is the turn signal power as well as the brake light power. This wire will have interrupted switched power from the turn flasher any time the right turn signal is activated and interrupted battery power from the hazard flasher any time the hazard switch is

in the ON position. This wire will also have battery power anytime the brake pedal is pressed. This wire can be seen in the [1970-1973 Tail Harness Power](#) diagram on page 117.

Brown: 18 gauge wire, not printed, this is a power wire for the tail light function. This wire will have power anytime the headlight switch is in the Park/Tail Lights ON or Headlights ON position. This wire, along with all the other wires and splices it is associated with, can be seen in the [1970-1973 Tail Harness Power](#) diagram on page 117.

Black: 18 gauge wire, not printed, this wire provides a ground source for the Turn/Brake/Tail Light and comes from a splice that is tied to a series of other splices that tie all the grounds in this harness together. This wire, along with all the other ground wires and splices, can be seen in the [1970-1973 Tail Harness Grounds](#) diagram on page 117.

- Insert a bulb from the parts kit into the socket..This socket requires a dual filament bulb, while supplied in the kit, it can also be purchased from just about any auto parts store under part # 1157. The turn signal will be the brighter of the two filaments.
- With the bulb in place, insert the socket into the bottom of the lens. Tuning the socket ¼ turn will lock it in place. Notice the keying on the bucket and the socket will only allow the socket to be installed one way. This connection, along with the next connection, may be easier to make if the lens bucket is removed from the car.

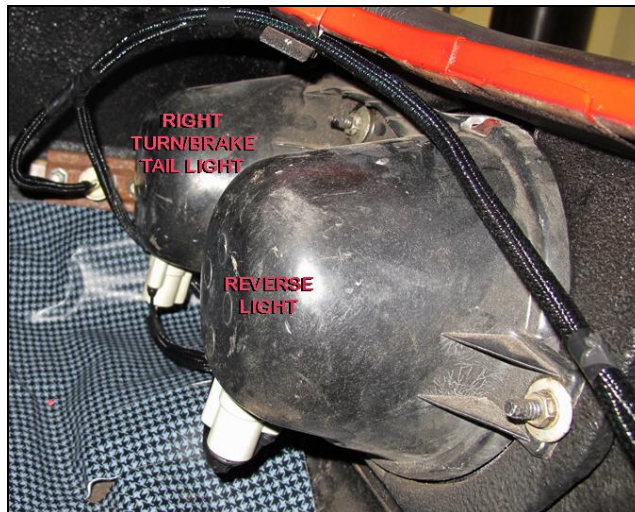

“Reverse Light”

This will be the lens closest to the center of the car, lens with the clear center. This connection will have a section label reading “RIGHT REVERSE LIGHT” and will have a two wire socket pre-installed. The two wires in this socket are:



Light Green- 18 gauge wire, not printed, this wire will provide power to the reverse or back up lights. This wire receives power from the reverse switch and will have power anytime the shifter is in the *REVERSE* position. This wire can be seen in the [1970-1973 Tail Harness Power](#) diagram on page 117.

Black: 18 gauge wire, not printed, this wire provides a ground source for the reverse light and comes from a splice that is tied to a series of other splices that tie all the grounds in this harness together. This wire, along with all the other ground wires and splices, can be seen in the [1970-1973 Tail Harness Grounds](#) diagram on page 117.

- Insert a bulb from the parts kit into the socket. This socket requires a single filament bulb, while supplied in the kit, it can also be purchased from just about any auto parts store under part # 1156.
- With the bulb in place, insert the socket into the bottom of the lens. Turning the socket ¼ turn will lock it in place. Notice the keying on the bucket and the socket will only allow the socket to be installed one way.

“Passenger Side Park Light”

The passenger side mounted park light is the last connection. The park, or marker light as it is often called, is activated by a power source coming from the headlight switch. This light will illuminate any time the headlight switch is in the *PARK* or *ON* position.



The park light requires two wires to work properly. A factory style socket comes pre-installed and will have a label reading “PASS. SIDE PARK LIGHT”. The wires spliced to this molded connector are:

Brown: 18 gauge wire, not printed, this is a power wire for the park or marker light function. This wire will have power anytime the headlight switch is in the Park/Tail Lights ON or Headlights ON position. This wire, along with all the other wires and splices it is associated with, can be seen in the [1970-1973 Tail Harness Power](#) diagram on page 117.

Black: 18 gauge wire, not printed, this wire provides a ground source for the park light and comes from a splice that is tied to a series of other splices that tie all the grounds in this harness together. This wire, along with all the other ground wires and splices, can be seen in the [1970-1973 Tail Harness Grounds](#) diagram on page 117.

- Begin by installing the correct bulb, included with the harness, into the socket. This will be a 194 bulb.
- Looking at the back of the park light housing you will see that it has a keyed opening to correspond with the tabs on the socket. (as seen in the photo)



- Insert the lamp socket of the Painless harness into the park light housing and turn ¼ turn to lock the socket in place.

Go to Testing the System on page 147

1974-1977 TAIL HARNESS GROUNDS

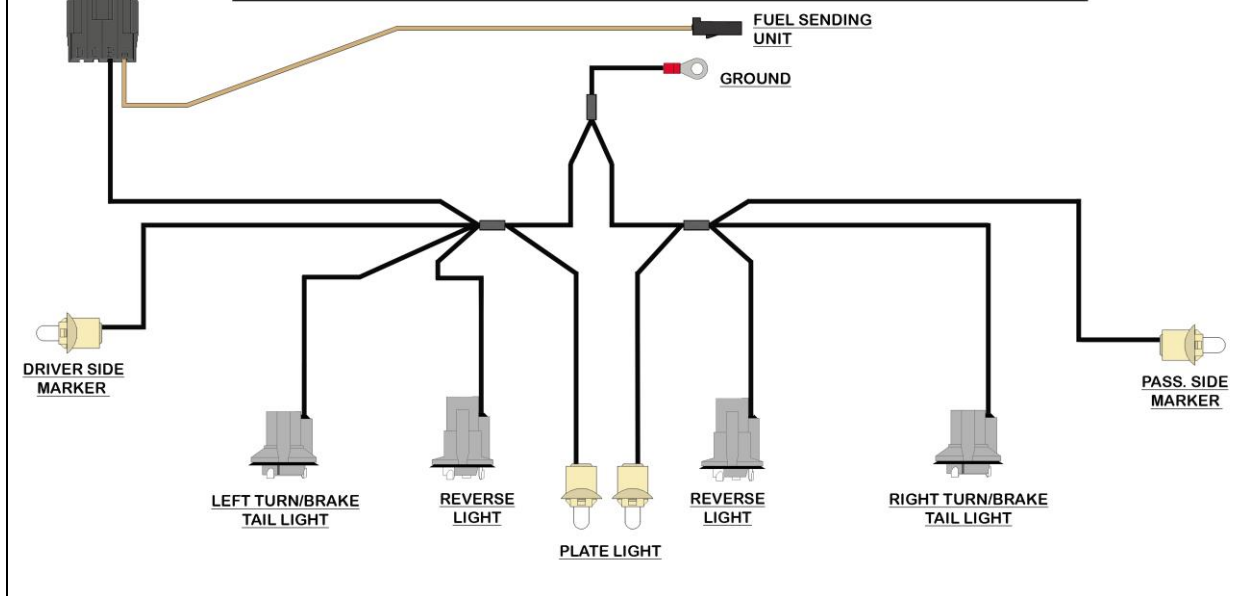

1974-1977 TAIL HARNESS POWER

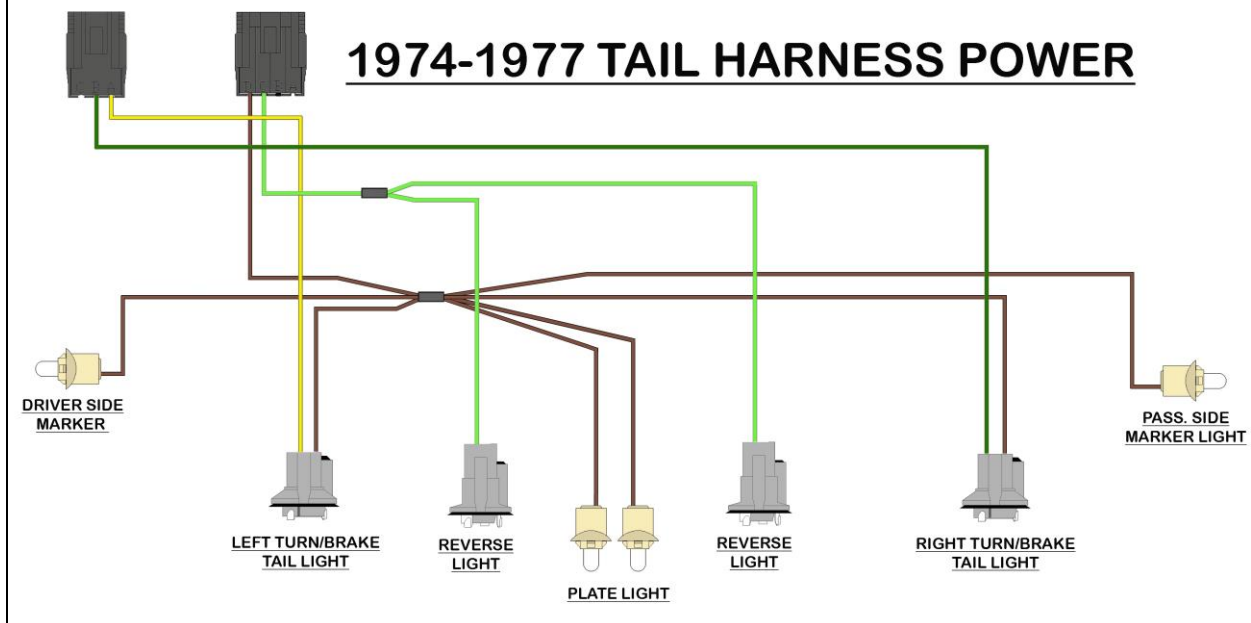

- Begin the installation by plugging the Tail Harness into the two connectors found on the tail section of the main harness. Once connected these connectors can be tucked out of sight, down into the rear quarter.

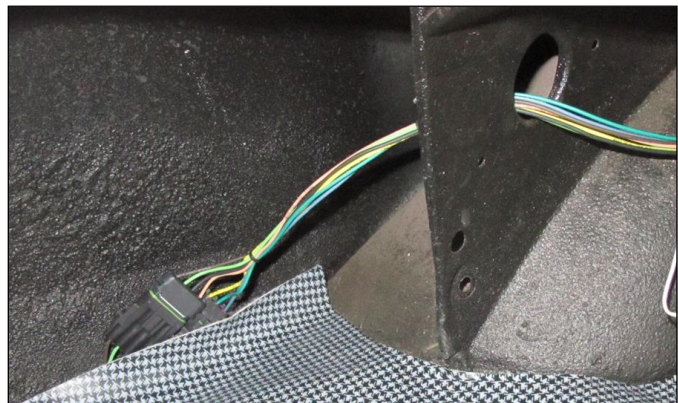
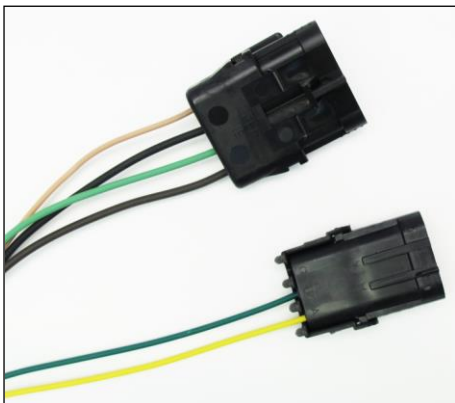

“Driver Side Park Light”

The driver side park light is the first connection. The park, or marker light as it is often called, is activated by a power source coming from the headlight switch. This light will illuminate any time the headlight switch is in the *PARK* or *ON* position.

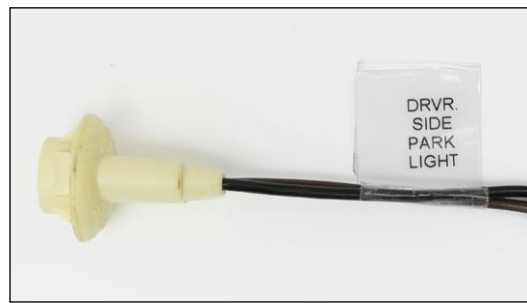

The park light requires two wires to work properly. A factory style socket comes pre-installed and will have a label reading “DRVR. SIDE PARK LIGHT”. The wires spliced to this molded connector are:

Brown: 18 gauge wire, not printed, this is a power wire for the park or marker light function. This wire will have power anytime the headlight switch is in the Park/Tail Lights ON or Headlights ON position. This wire, along with all the other wires and splices it is associated with, can be seen in the [1974-1977 Tail Harness Power](#) diagram on page 128.

Black: 18 gauge wire, not printed, this wire provides a ground source for the park light and comes from a splice that is tied to a series of other splices that tie all the grounds in this harness together. This wire, along with all the other ground wires and splices, can be seen in the [1974-1977 Tail Harness Grounds](#) diagram on page 128.

- Begin by installing the correct bulb, included with the harness, into the socket. This will be a 194 bulb.
- Looking at the back of the tail light lens, you will see the park light down in the corner. You will see that it has a keyed opening to correspond with the tabs on the socket. (as seen in the photo below). This connection, along with the next connection, may be easier to make if the lens bucket is removed from the car.
- Insert the lamp socket of the Painless harness into the park light housing and turn ¼ turn to lock the socket in place. The use of needle nose pliers may be needed in order to reach the opening in the lens since it is so far down into the corner. The longer socket that was used by GM during actual production of these vehicles is no longer available.



“Left Turn/Brake/Tail Light”

This connection will have a section label reading “L. TURN/BRAKE TAIL LIGHT” and a three wire socket pre-installed. The three wires found in this socket are:

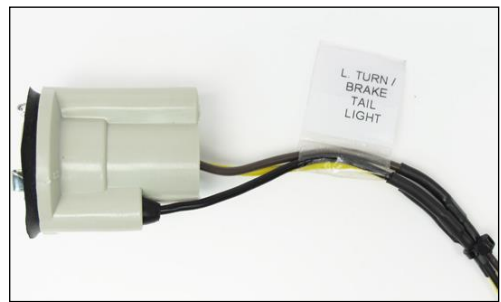

Yellow- 18 gauge wire, not printed, this wire is the turn signal power as well as the brake light power.

This wire will have interrupted switched power from the turn flasher any time the left turn signal is activated and interrupted battery power from the hazard flasher any time the hazard switch is in the ON position. This wire will also have battery power anytime the brake pedal is pressed. This wire can be seen in the [1974-1977 Tail Harness Power](#) diagram on page 128.

Brown: 18 gauge wire, not printed, this is a power wire for the tail light function. This wire will have power anytime the headlight switch is in the Park/Tail Lights ON or Headlights ON position. This wire, along with all the other wires and splices it is associated with, can be seen in the [1974-1977 Tail Harness Power](#) diagram on page 128.

Black: 18 gauge wire, not printed, this wire provides a ground source for the Turn/Brake/Tail Light and comes from a splice that is tied to a series of other splices that tie all the grounds in this harness together. This wire, along with all the other ground wires and splices, can be seen in the [1974-1977 Tail Harness Grounds](#) diagram on page 128.

- Insert a bulb from the parts kit into the socket. This socket requires a dual filament bulb, while supplied in the kit, it can also be purchased from just about any auto parts store under part # 1157. The turn signal will be the brighter of the two filaments.
- With the bulb in place, insert the socket into the lens. Tuning the socket ¼ turn will lock it in place. Notice the keying on the bucket and the socket will only allow the socket to be installed one way.

“Reverse Light”

This will be the lens closest to the center of the car, lens with the clear center. This connection will have a section label reading “LEFT REVERSE LIGHT” and will have a two wire socket pre-installed. The two wires in this socket are:

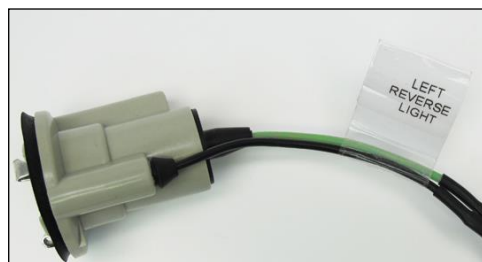

Light Green- 18 gauge wire, not printed, this wire will provide power to the reverse or back up lights. This wire receives power from the reverse switch and will have power anytime the shifter is in the *REVERSE* position. This wire can be seen in the [1974-1977 Tail Harness Power](#) diagram on page 128.

Black: 18 gauge wire, not printed, this wire provides a ground source for the reverse light and comes from a splice that is tied to a series of other splices that ties all the grounds in this harness together. This wire, along with all the other ground wires and splices, can be seen in the [1974-1977 Tail Harness Grounds](#) diagram on page 128.

- Insert a bulb from the parts kit into the socket. This socket requires a single filament bulb, while supplied in the kit, it can also be purchased from just about any auto parts store under part # 1156.
- With the bulb in place, insert the socket into the bottom of the lens. Turning the socket ¼ turn will lock it in place. Notice the keying on the bucket and the socket will only allow the socket to be installed one way. This connection, along with the next connection, may be easier to make if the lens bucket is removed from the car.

ROUTING

Now that the driver's side light sockets have been installed, the harness will be routed along the top of the trunk to the center of the vehicle and then to the passenger side. Use the factory harness clips to secure the harness in place.

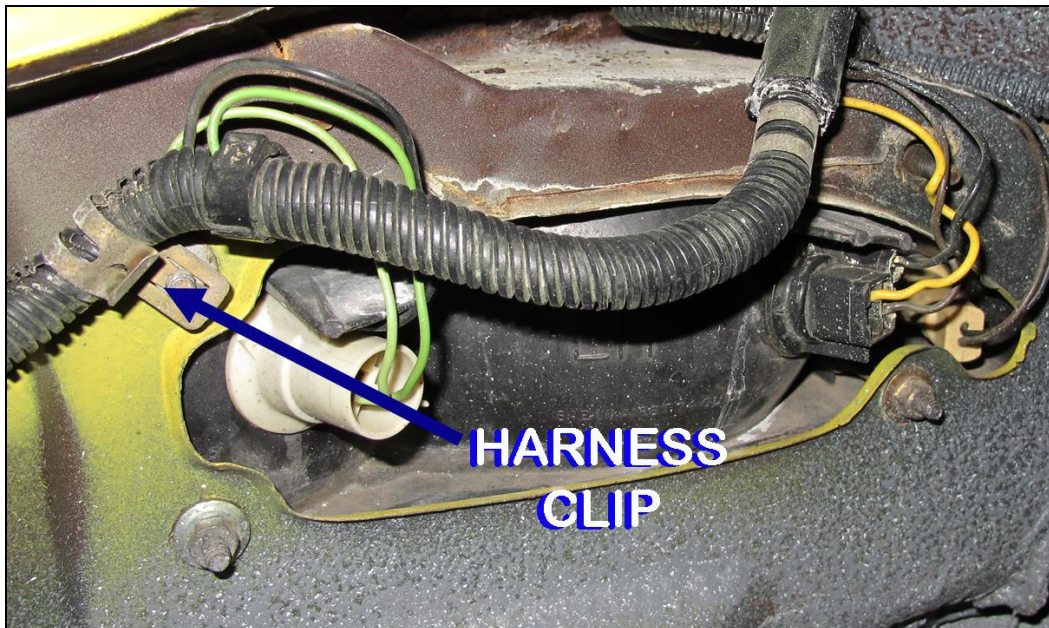

“License Plate Lights”

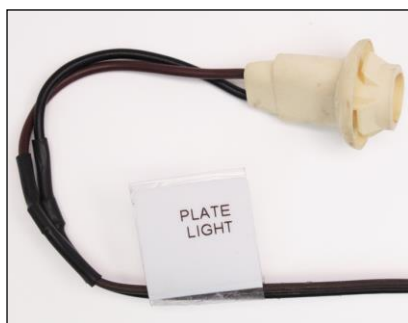

The plate lights are the next connections needing to be made. These lights are tied to the rear marker lights and will illuminate the license plate during low light conditions when the headlight switch is in the park light “ON” or headlight “ON” positions.

The wires in the Painless harness for this function will have labels reading “PLATE LIGHT”. These two wires will have lamp sockets pre-installed, they are:

Brown: 18 gauge wires, not printed, these are power wires for the license plate light function. These wires will have power anytime the headlight switch is in the Park/Tail Lights ON or Headlights ON position. This wire, along with all the other wires and splices it is associated with, can be seen in the [1974-1977 Tail Harness Power](#) diagram on page 128.

Black: 18 gauge wires, not printed, these wires provide a ground source for the license plate lights and comes from a splice that is tied to a series of other splices that tie all the grounds in this harness together. This wire, along with all the other ground wires and splices, can be seen in the [1974-1977 Tail Harness Grounds](#) diagram on page 128.

- Install a small bulb from the parts kit into each socket. These bulbs are known as 194 series bulbs and can be purchased at just about any place auto parts are sold.
- Install the plate light sockets into the plate light lenses, turning ¼ turn to lock them in place.

“Ground”

The ground connection in the Tail Harness will tie all of the grounds found in the Tail harness to a common ground source. One wire, marked with a section label reading “GROUND”, makes up this connection. This wire will have a ring terminal pre-installed, this wire is:

Black: 10 gauge wire, not printed, this wire provides a ground source for the Tail harness from a splice that is tied to a series of other splices that tie all the grounds in this harness together. This wire, along with all the other ground wires and splices, can be seen in the [1974-1977 Tail Harness Grounds](#) diagram on page 128.

- Connect this black ground wire to a good clean chassis ground source, like one of the mounting bolts for the trunk latch or to the factory location on the trunk latch bracket, seen circled in the photo of the factory harness.

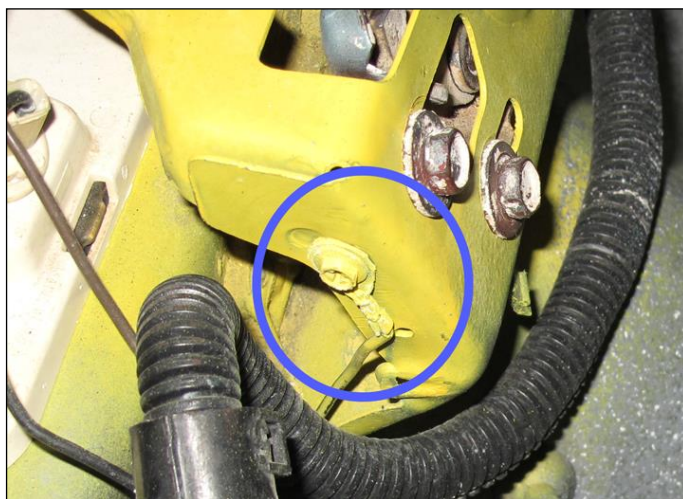

“Fuel Sending Unit”

The fuel sending unit connection will be a one wire connection. This wire will send a resisted ground source from the fuel level sending unit inside the fuel tank, to the fuel gauge on the dash. This resistance is based off how much fuel remains in the tank, which causes the needle on the gauge to move between empty and full.

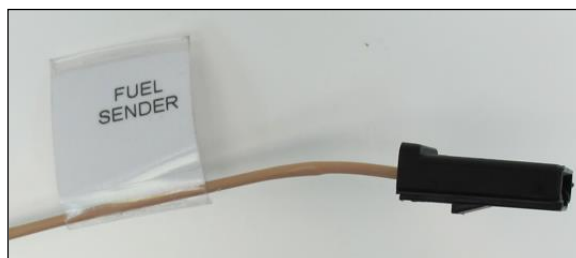

The wire provided in the Tail Harness will have a section label reading “FUEL SENDER”. This wire will have a single pin black connector pre-installed, this wire is:

Tan: 18 gauge wire, not printed, this wire will a ground signal. It can be seen in the [1974-1977 Tail Harness Grounds](#) diagram on page 128.

- Locate the factory wire coming through the trunk floor, just below the trunk latch. Connect the single pin connector and wire found on the Tail Harness to this factory wire, as seen here in the photo of the factory harness.



“Reverse Light”

This will be the lens closest to the center of the car, lens with the clear center. This connection will have a section label reading “RIGHT REVERSE LIGHT” and will have a two wire socket pre-installed. The two wires in this socket are:

Light Green- 18 gauge wire, not printed, this wire will provide power to the reverse or back up lights. This wire receives power from the reverse switch and will have power anytime the shifter is in the *REVERSE* position. This wire can be seen in the [1974-1977 Tail Harness Power](#) diagram on page 128.

Black: 18 gauge wire, not printed, this wire provides a ground source for the reverse light and comes from a splice that is tied to a series of other splices that tie all the grounds in this harness together. This wire, along with all the other ground wires and splices, can be seen in the [1974-1977 Tail Harness Grounds](#) diagram on page 128.

- Insert a bulb from the parts kit into the socket. This socket requires a single filament bulb, while supplied in the kit , it can also be purchased from just about any auto parts store under part # 1156.
- With the bulb in place, insert the socket into the bottom of the lens. Turning the socket ¼ turn will lock it in place. Notice the keying on the bucket and the socket will only allow the socket to be installed one way. This connection, along with the next couple connections, may be easier to make if the lens bucket is removed from the car.



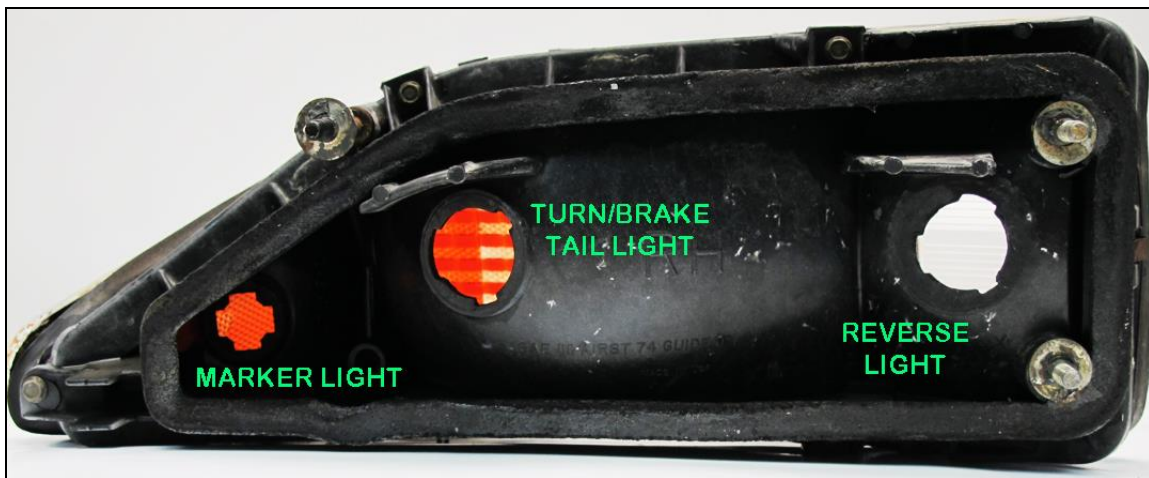

“Right Turn/Brake/Tail Light”

The lens in the center of the tail light assembly is for the right Turn/Brake/Tail Light. This connection will have a section label reading “R. TURN/BRAKE TAIL LIGHT” and a three wire socket pre-installed. The three wires found in this socket are:



Green- 18 gauge wire, not printed, this wire is the turn signal power as well as the brake light power. This wire will have interrupted switched power from the turn flasher any time the right turn signal is activated and interrupted battery power from the hazard flasher any time the hazard switch is in the ON position. This wire will also have battery power anytime the brake pedal is pressed. This wire can be seen in the [1977-1977 Tail Harness Power](#) diagram on page 128.

Brown: 18 gauge wire, not printed, this is a power wire for the tail light function. This wire will have power anytime the headlight switch is in the Park/Tail Lights ON or Headlights ON position. This wire, along with all the other wires and splices it is associated with, can be seen in the [1974-1977 Tail Harness Power](#) diagram on page 128.

Black: 18 gauge wire, not printed, this wire provides a ground source for the Turn/Brake/Tail Light and comes from a splice that is tied to a series of other splices that tie all the grounds in this harness together. This wire, along with all the other ground wires and splices, can be seen in the [1974-1977 Tail Harness Grounds](#) diagram on page 128.

- Insert a bulb from the parts kit into the socket. This socket requires a dual filament bulb, while supplied in the kit, it can also be purchased from just about any auto parts store under part # 1157. The turn signal will be the brighter of the two filaments.
- With the bulb in place, insert the socket into the bottom of the lens. Tuning the socket ¼ turn will lock it in place. Notice the keying on the bucket and the socket will only allow the socket to be installed one way. This connection, along with the next connection, may be easier to make if the lens bucket is removed from the car.

“Passenger Side Park Light”

The passenger side park light is the last connection. The park, or marker light as it is often called, is activated by a power source coming from the headlight switch. This light will illuminate any time the headlight switch is in the *PARK* or *ON* position.

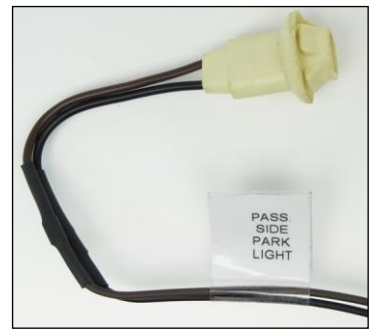

The park light requires two wires to work properly. A factory style socket comes pre-installed and will have a label reading “PASS. SIDE PARK LIGHT”. The wires spliced to this molded connector are:

Brown: 18 gauge wire, not printed, this is a power wire for the park or marker light function. This wire will have power anytime the headlight switch is in the Park/Tail Lights ON or Headlights ON position. This wire, along with all the other wires and splices it is associated with, can be seen in the [1974-1977 Tail Harness Power](#) diagram on page 128.

Black: 18 gauge wire, not printed, this wire provides a ground source for the park light and comes from a splice that is tied to a series of other splices that tie all the grounds in this harness together. This wire, along with all the other ground wires and splices, can be seen in the [1974-1977 Tail Harness Grounds](#) diagram on page 128.

- Begin by installing the correct bulb, included with the harness, into the socket. This will be a 194 bulb.
- Looking at the back of the park light housing you will see that it has a keyed opening to correspond with the tabs on the socket. (as seen in the photo)
- Insert the lamp socket of the Painless harness into the park light housing and turn ¼ turn to lock the socket in place. The use of needle nose pliers may be needed in order to reach the opening in the lens since it is so far down into the corner. The longer socket that was used by GM during actual production of these vehicles is no longer available.

Go to Testing the System on page 147

1978-1981 TAIL HARNESS INSTALLATION



You will notice that the wires found on the tail harness are not printed with wire information; this is because all wires go into connectors so no individual connections are really needed. Page 114 and 115 lists a circuit number for each wire found in the Tail harness based on the wire color. Diagrams of the wires found in the Tail harness can be seen on the next page.

- Begin by examining the section label on the supplied tail harness to ensure you have the correct tail harness for your application. The section label should read "1978-1981".



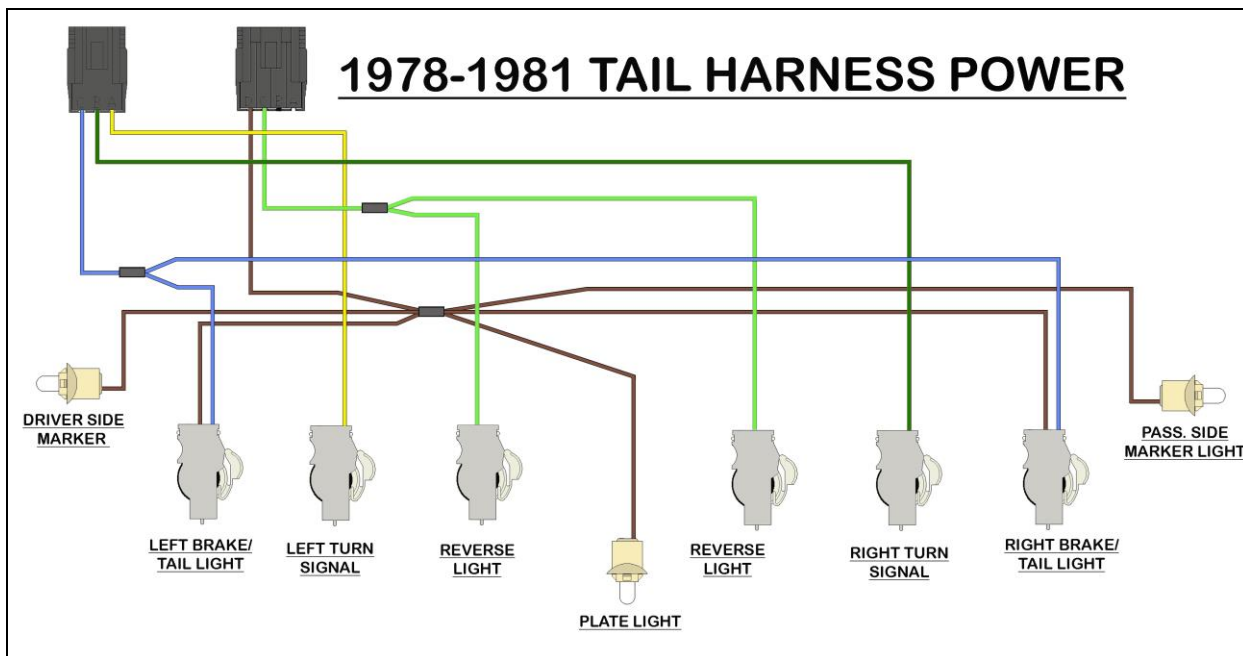
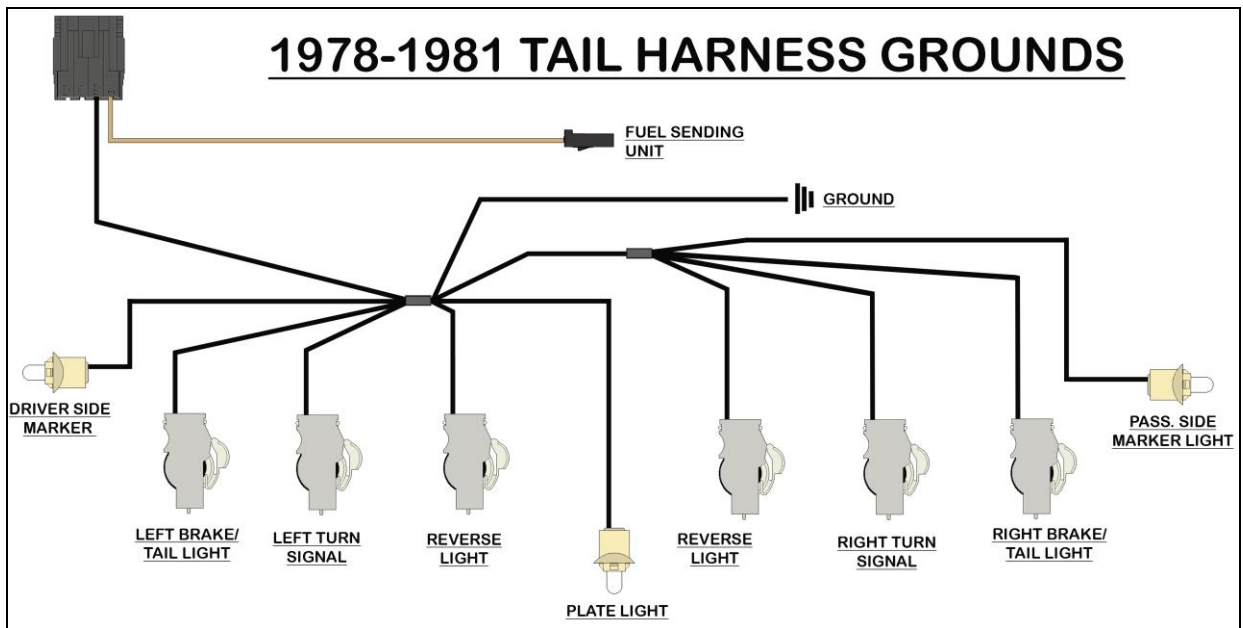

- Begin the installation by removing the tail light lenses from the car to gain access to the hole on the driver side for harness pass through, seen circled below.



- Insert the two black connectors found on the tail harness, in the middle of this page, and feed the harness into the trunk until the grommet that has been pre-installed on the tail harness is seated in the hole.

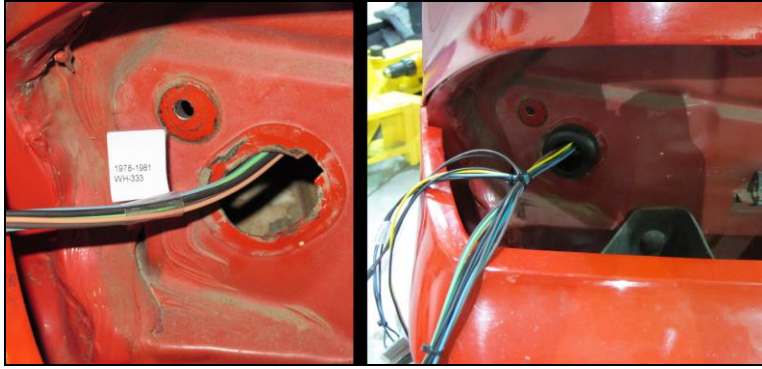

- In the trunk, you can now plug the two connectors on the Tail Harness into the two connectors found on the tail section of the main harness. Once connected these connectors can be tucked out of sight, down into the rear quarter panel.

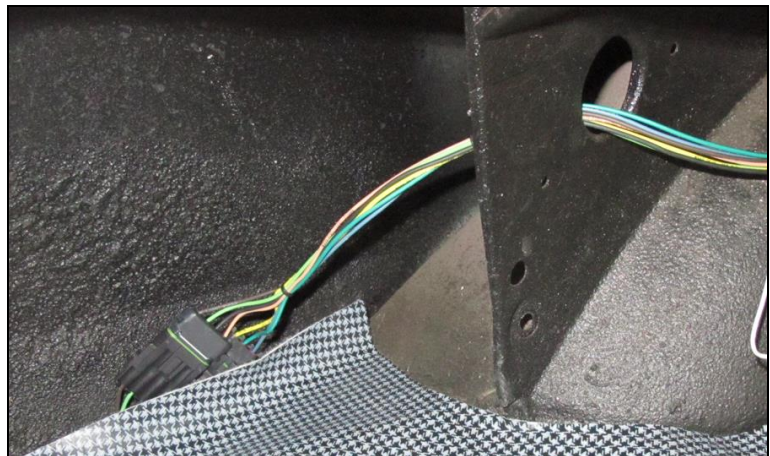
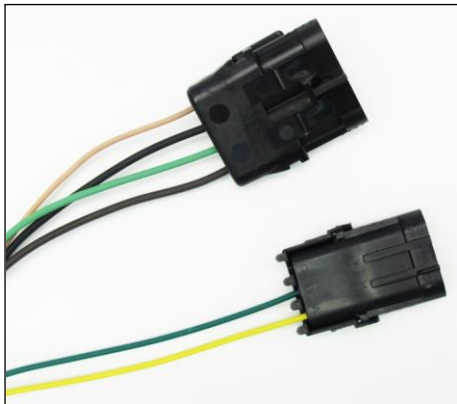

- You can now move out to the tail light area and route the harness across the rear of the car. Use the harness clips to secure the harness. Take notice on how the harness in the photo routes down under the filler neck to several clips that are located behind the bumper and then back up to the passenger side of the gas filler neck.

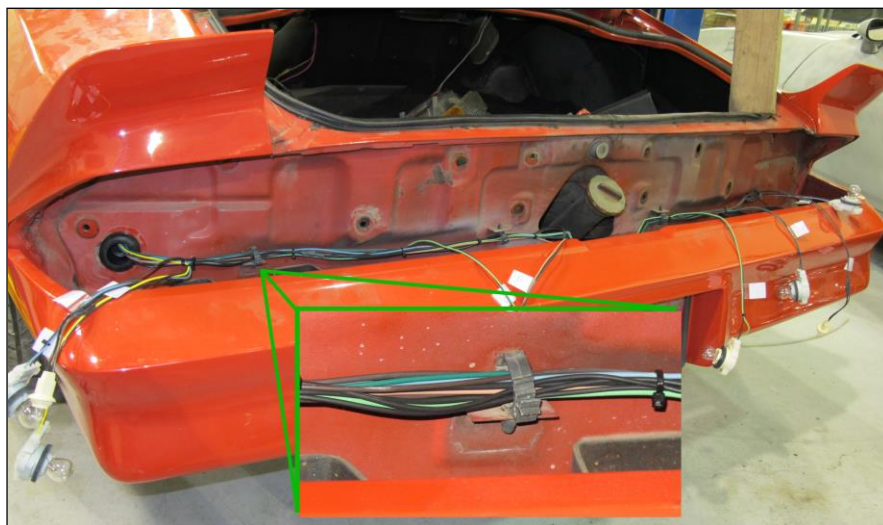

“Driver Side Park Light”

The driver side park light is the next connection. The park, or marker light as it is often called, is activated by a power source coming from the headlight switch. This light will illuminate any time the headlight switch is in the *PARK* or *ON* position.

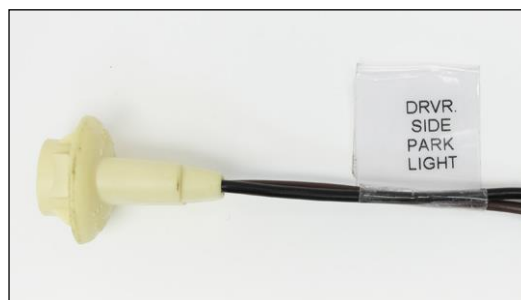

The park light requires two wires to work properly. A factory style socket comes pre-installed and will have a label reading “DRVR. SIDE PARK LIGHT”. The wires spliced to this molded connector are:

Brown: 18 gauge wire, not printed, this is a power wire for the park or marker light function. This wire will have power anytime the headlight switch is in the Park/Tail Lights ON or Headlights ON position. This wire, along with all the other wires and splices it is associated with, can be seen in the [1978-1981 Tail Harness Power](#) diagram on page 137.

Black: 18 gauge wire, not printed, this wire provides a ground source for the park light and comes from a splice that is tied to a series of other splices that tie all the grounds in this harness together. This wire, along with all the other ground wires and splices, can be seen in the [1978-1981 Tail Harness Grounds](#) diagram on page 137.

- Begin by installing the correct bulb, included with the harness, into the socket. This will be a 194 bulb.
- Looking at the back of the tail light lens, you will see the park light opening. You will see that it has a keyed opening to correspond with the tabs on the socket, as seen in the photo on page 141.
- Insert the lamp socket of the Painless harness into the park light housing and turn ¼ turn to lock the socket in place.

“Left Brake/Tail Light”

This connection will have a section label reading “BRAKE/ TAIL LIGHT” and a three wire socket pre-installed. The three wires found in this socket are:



Light Blue- 18 gauge wire, not printed, this wire is the brake light power. This wire will have battery power anytime the brake pedal is pressed. This wire can be seen in the [1978-1981 Tail Harness Power](#) diagram on page 137.

Brown: 18 gauge wire, not printed, this is a power wire for the tail light function. This wire will have power anytime the headlight switch is in the Park/Tail Lights ON or Headlights ON position. This wire, along with all the other wires and splice it is associated with, can be seen in the [1978-1981 Tail Harness Power](#) diagram on page 137.

Black: 18 gauge wire, not printed, this wire provides a ground source for the Turn/Brake/Tail Light and comes from a splice that is tied to a series of other splices that tie all the grounds in this harness together. This wire, along with all the other ground wires and splices, can be seen in the [1978-1981 Tail Harness Grounds](#) diagram on page 137.

- Insert a bulb from the parts kit into the socket..This socket requires a dual filament bulb, while supplied in the kit, it can also be purchased from just about any auto parts store under part # 1157. The turn signal will be the brighter of the two filaments.
- With the bulb in place, insert the socket into the lens. Tuning the socket ¼ turn will lock it in place. Notice the keying on the bucket and the socket will only allow the socket to be installed one way.

“Left Turn Signal”

This connection will have a section label reading “L. TURN” and a 2 wire socket pre-installed. The three wires found in this socket are:

Yellow- 18 gauge wire, not printed, this wire is the turn signal power. This wire will have interrupted switched power from the turn flasher any time the left turn signal is activated and interrupted battery power from the hazard flasher any time the hazard switch is in the ON position. This wire will also have battery power anytime the brake pedal is pressed. This wire can be seen in the [1978-1981 Tail Harness Power](#) diagram on page 137.

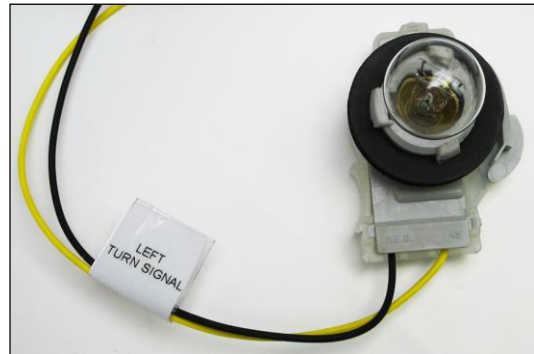

Black: 18 gauge wire, not printed, this wire provides a ground source for the Turn/Brake/Tail Light and comes from a splice that is tied to a series of other splices that tie all the grounds in this harness together. This wire, along with all the other ground wires and splices, can be seen in the [1978-1981 Tail Harness Grounds](#) diagram on page 137.

- Insert a bulb from the parts kit into the socket. This socket requires a dual filament bulb, while supplied in the kit, it can also be purchased from just about any auto parts store under part # 1157. The turn signal will be the brighter of the two filaments.
- With the bulb in place, insert the socket into the lens. Tuning the socket ¼ turn will lock it in place. Notice the keying on the bucket and the socket will only allow the socket to be installed one way.

“Reverse Light”

This will be the lens closest to the center of the car, lens with the clear center. This connection will have a section label reading “LEFT REVERSE LIGHT” and will have a two wire socket pre-installed. The two wires in this socket are:



Light Green- 18 gauge wire, not printed, this wire will provide power to the reverse or back up lights. This wire receives power from the reverse switch and will have power anytime the shifter is in the *REVERSE* position. This wire can be seen in the [1978-1981 Tail Harness Power](#) diagram on page 137.

Black: 18 gauge wire, not printed, this wire provides a ground source for the reverse light and comes from a splice that is tied to a series of other splices that tie all the grounds in this harness together. This wire, along with all the other ground wires and splices, can be seen in the [1978-1981 Tail Harness Grounds](#) diagram on page 137.

- Insert a bulb from the parts kit into the socket. This socket requires a single filament bulb, while supplied in the kit, it can also be purchased from just about any auto parts store under part # 1156.
- With the bulb in place, insert the socket into the bottom of the lens. Turning the socket ¼ turn will lock it in place. Notice the keying on the bucket and the socket will only allow the socket to be installed one way.

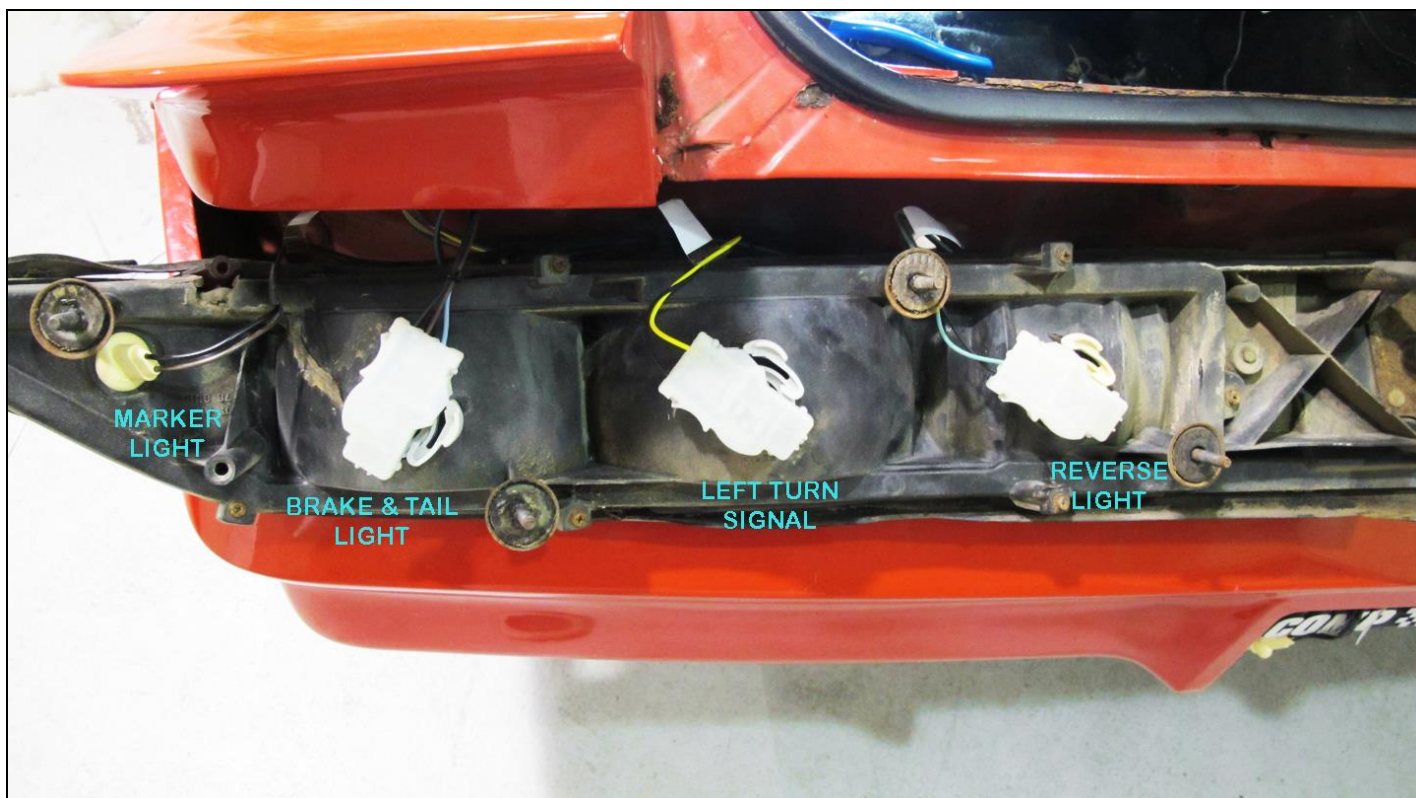

“License Plate Lights”

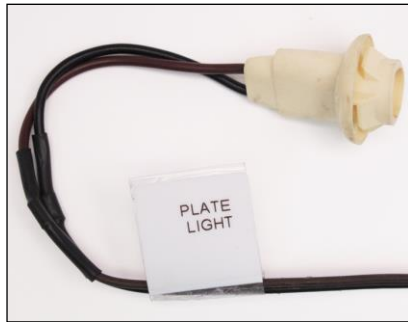

The plate lights are the next connections needing to be made. These lights are tied to the rear marker lights and will illuminate the license plate during low light conditions when the headlight switch is on.

The wires in the Painless harness for this function will have labels reading “PLATE LIGHT”. These two wires will have lamp sockets pre-installed, they are:

Brown: 18 gauge wires, not printed, these are power wires for the license plate light function. These wires will have power anytime the headlight switch is in the Park/Tail Lights ON or Headlights ON position. This wire, along with all the other wires and splices it is associated with, can be seen in the [1978-1981 Tail Harness Power](#) diagram on page 137.

Black: 18 gauge wires, not printed, these wires provide a ground source for the license plate lights and comes from a splice that is tied to a series of other splices that tie all the grounds in this harness together. This wire, along with all the other ground wires and splices, can be seen in the [1978-1981 Tail Harness Grounds](#) diagram on page 137.

- Install a small bulb from the parts kit into each socket. These bulbs are known as 194 series bulbs and can be purchased at just about any place auto parts are sold.
- Install the plate light sockets into the plate light lenses, turning ¼ turn to lock them in place.

“Ground”

The ground connection in the Tail Harness will tie all of the grounds found in the Tail harness to a common ground source. One wire, marked with a section label reading “GROUND”, makes up this connection.

Black: 10 gauge wire, not printed, this wire provides a ground source for the Tail harness from a splice that is tied to a series of other splices that tie all the grounds in this harness together. This wire, along with all the other ground wires and splices, can be seen in the [1978-1981 Tail Harness Grounds](#) diagram on page 137.

- Using a ring terminal from the parts kit, connect this black ground wire to a good clean chassis ground source, such as one of the mounting bolts for the trunk latch.

“Fuel Sending Unit”

The fuel sending unit connection will be a one wire connection. This wire will send a resisted ground source from the fuel level sending unit inside the fuel tank, to the fuel gage on the dash. This resistance is based off how much fuel remains in the tank, which causes the needle on the gauge to move between empty and full.

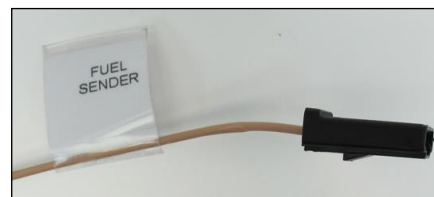

The wire provided in the Tail Harness will have a section label reading “FUEL SENDER”. This wire will have a single pin black connector and a grommet pre-installed, this wire is:

Tan: 18 gauge wire, not printed, this wire will a ground signal. It can be seen in the [1978-1981 Tail Harness Grounds](#) diagram on page 137.

- Insert the single pin connector through the small hole located to the lower right side of the fuel filler neck. Seat the pre-installed grommet into the hole. The use of a small flat head screw driver may be needed to help get the grommet seated properly.

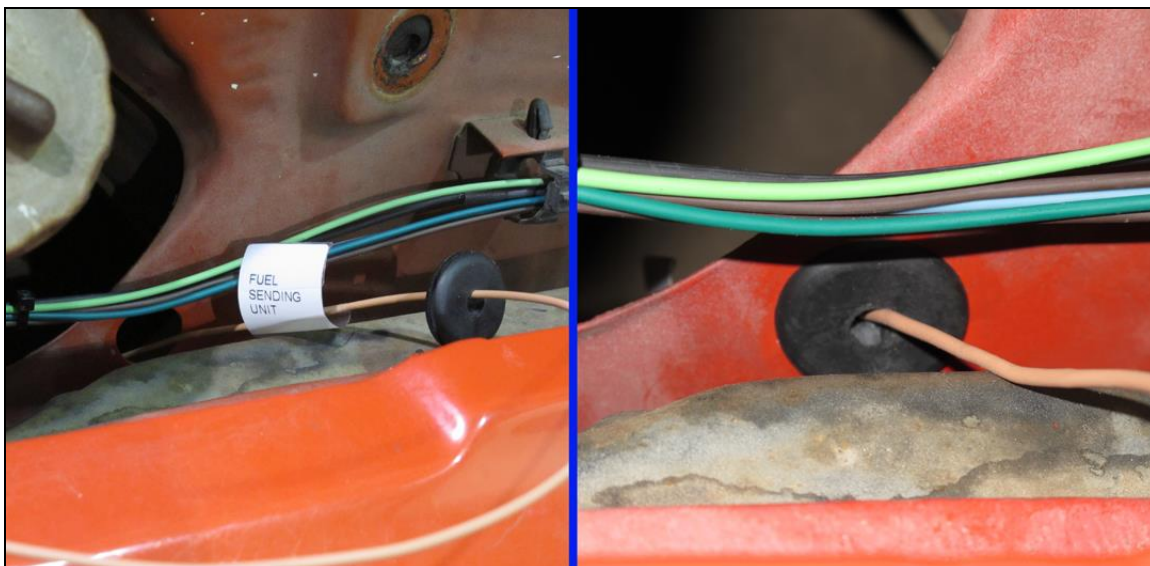

- Locate the factory wire coming from the fuel tank sending unit, behind the rear bumper. Connect the single pin connector and wire found on the Tail Harness to this factory wire as shown in the photo to the right.



“Reverse Light”

This will be the lens closest to the center of the car, lens with the clear center. This connection will have a section label reading “RIGHT REVERSE LIGHT” and will have a two wire socket pre-installed. The two wires in this socket are:

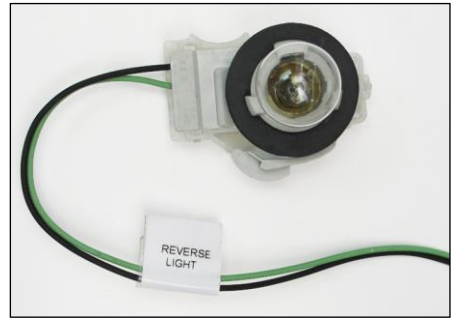

Light Green- 18 gauge wire, not printed, this wire will provide power to the reverse or back up lights. This wire receives power from the reverse switch and will have power anytime the shifter is in the *REVERSE* position. This wire can be seen in the [1978-1981 Tail Harness Power](#) diagram on page 137.

Black: 18 gauge wire, not printed, this wire provides a ground source for the reverse light and comes from a splice that is tied to a series of other splices that tie all the grounds in this harness together. This wire, along with all the other ground wires and splices, can be seen in the [1978-1981 Tail Harness Grounds](#) diagram on page 137.

- Insert a bulb from the parts kit into the socket. This socket requires a single filament bulb, while supplied in the kit, it can also be purchased from just about any auto parts store under part # 1156.
- With the bulb in place, insert the socket into the bottom of the lens. Turning the socket ¼ turn will lock it in place. Notice the keying on the bucket and the socket will only allow the socket to be installed one way.

“Right Turn Signal”

The middle /amber lens will be for the right Turn Signal. This connection will have a section label reading “R. TURN/BRAKE TAIL LIGHT” and a three wire socket pre-installed. The three wires found in this socket are:

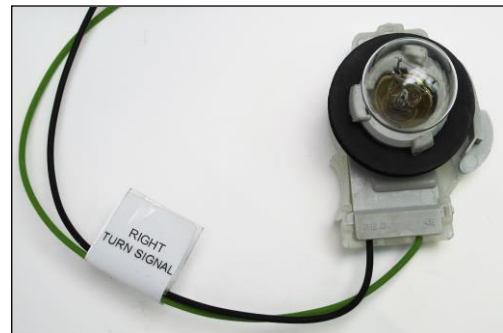

Green- 18 gauge wire, not printed, this wire is the turn signal. This wire will have interrupted switched power from the turn flasher any time the right turn signal is activated and interrupted battery power from the hazard flasher any time the hazard switch is in the ON position.. This wire can be seen in the [1978-1981 Tail Harness Power](#) diagram on page 137.

Black: 18 gauge wire, not printed, this wire provides a ground source for the turn signal and comes from a splice that is tied to a series of other splices that tie all the grounds in this harness together. This wire, along with all the other ground wires and splices, can be seen in the [1978-1981 Tail Harness Grounds](#) diagram on page 137.

- Insert a bulb from the parts kit into the socket..This socket requires a dual filament bulb, while supplied in the kit, it can also be purchased from just about any auto parts store under part # 1157. The turn signal will be the brighter of the two filaments.

- With the bulb in place, insert the socket into the bottom of the lens. Tuning the socket ¼ turn will lock it in place. Notice the keying on the bucket and the socket will only allow the socket to be installed one way.

“Right Brake/Tail Light”

The lens closest to the passenger side quarter panel will be for the right Turn/Brake/Tail Light. This connection will have a section label reading “ BRAKE/TAIL LIGHT” and a three wire socket pre-installed. The three wires found in this socket are:



Light Blue- 18 gauge wire, not printed, this wire is the brake light power. This wire will have battery power anytime the brake pedal is pressed. This wire can be seen in the [1978-1981 Tail Harness Power](#) diagram on page 137.

Brown: 18 gauge wire, not printed, this is a power wire for the tail light function. This wire will have power anytime the headlight switch is in the Park/Tail Lights ON or Headlights ON position. This wire, along with all the other wires and splice it is associated with, can be seen in the [1978-1981 Tail Harness Power](#) diagram on page 137.

Black: 18 gauge wire, not printed, this wire provides a ground source for the Turn/Brake/Tail Light and comes from a splice that is tied to a series of other splices that tie all the grounds in this harness together. This wire, along with all the other ground wires and splices, can be seen in the [1978-1981 Tail Harness Grounds](#) diagram on page 137.

- Insert a bulb from the parts kit into the socket..This socket requires a dual filament bulb, while supplied in the kit, it can also be purchased from just about any auto parts store under part # 1157. The turn signal will be the brighter of the two filaments.
- With the bulb in place, insert the socket into the bottom of the lens. Tuning the socket ¼ turn will lock it in place. Notice the keying on the bucket and the socket will only allow the socket to be installed one way.

“Passenger Side Park Light”

The passenger side park light is the last connection. The park, or marker light as it is often called, is activated by a power source coming from the headlight switch. This light will illuminate any time the headlight switch is in the *PARK* or *ON* position.

The park light requires two wires to work properly. A factory style socket comes pre-installed and will have a label reading “PASS. SIDE PARK LIGHT”. The wires spliced to this molded connector are:



Brown: 18 gauge wire, not printed, this is a power wire for the park or marker light function. This wire will have power anytime the headlight switch is in the Park/Tail Lights ON or Headlights ON position. This wire, along with all the other wires and splices it is associated with, can be seen in the [1978-1981 Tail Harness Power](#) diagram on page 137.

Black: 18 gauge wire, not printed, this wire provides a ground source for the park light and comes from a splice that is tied to a series of other splices that tie all the grounds in this harness together. This wire, along with all the other ground wires and splices, can be seen in the [1978-1981 Tail Harness Grounds](#) diagram on page 137.

- Begin by installing the correct bulb, included with the harness, into the socket. This will be a 194 bulb.
- Looking at the back of the housing you will see that it has a keyed opening to correspond with the tabs on the socket. (as seen in the photo)
- Insert the lamp socket of the Painless harness into the park light housing and turn ¼ turn to lock the socket in place.

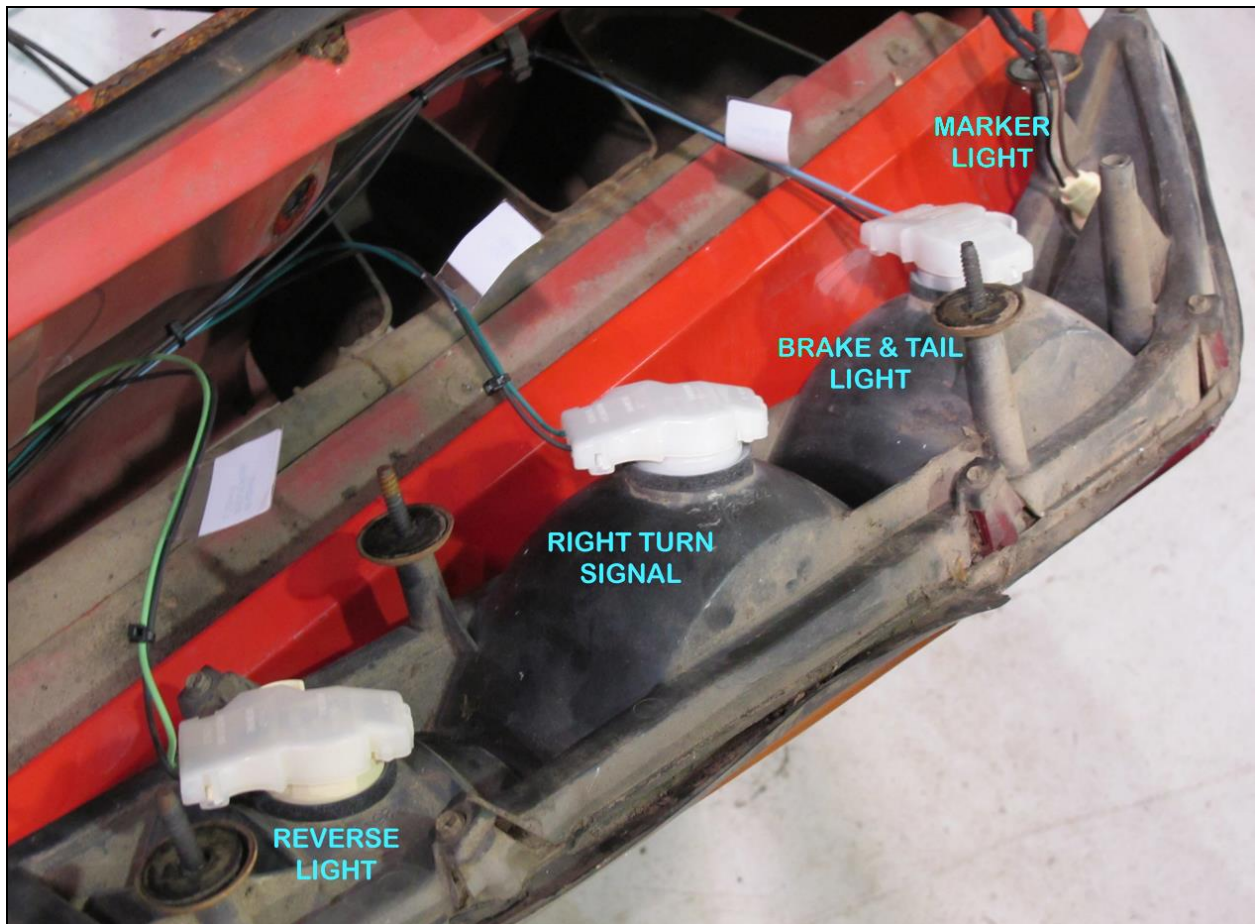

TESTING THE SYSTEM

Use a small (10 amp or less) battery charger to power up the vehicle for the first time to test the circuits. If there is a problem anywhere, the battery charger's low amperage and internal circuit breaker will provide circuit protection.

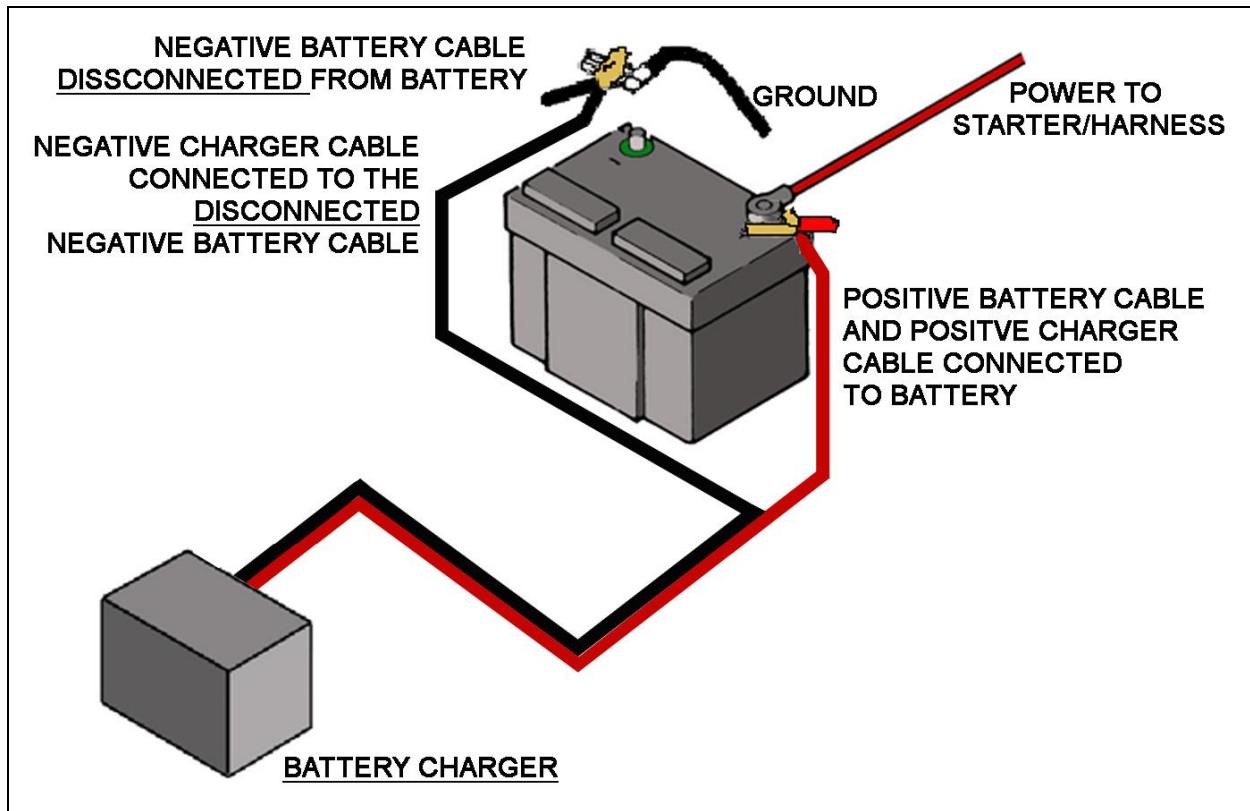

- Make sure the Negative Battery cable is connected to the frame or engine block, and make sure there is a ground between the engine and frame. **The negative battery cable should still be disconnected from the Battery** as instructed on page 5.
- Connect the Battery Positive cable to the Positive side of the Battery and also make sure this cable is connected to the B+ side of the Starter Solenoid. At this point this should also connect the red #915 from the Painless harness to the positive side of the battery, either through the starter lug or the battery lug.
- Connect the Battery Charger's NEGATIVE cable to the automobile chassis, engine block or to the disconnected Negative Battery cable. **Do NOT connect the Battery Charger's NEGATIVE cable to the Battery.**
- Connect the Battery Charger's POSITIVE cable to the automobile's positive battery terminal lug.
- INDIVIDUALLY turn on each light, ignition, wiper circuit, etc. and check for proper operation.

Note: If you try to test more than one circuit at a time, the charger will not provide enough amperage for each circuit to work correctly.

- After all circuits have been checked, disconnect the battery charger and attach the vehicles battery cables to the battery.
- Once testing is complete, re-install any panels, lens, or other parts that were removed during the harness installation. You are now finished installing this Painless Harness, congratulations!

WIRE INDEX

- The index is listed in the same order in which the manual instructed components to be connected.
- The **BLUE** descriptions indicate sections found throughout the harness.
- The **RED** indicate components/connection points.
- The descriptions shown in **ORANGE** are NOT actually printed on the wire. These are simply shown to provide the circuit number and the function in which that particular wire is associated.

ENGINE HARNESS

LOW BRAKE SWITCH

PRINT	GAUGE	COLOR	PRINTED MESSAGE ON WIRE	STARTING POINT
YES	18	TAN	#968 LOW BRAKE SWITCH	ENGINE BULK HEAD

LIGHT SECTION

WASHER PUMP

PRINT	GAUGE	COLOR	PRINTED MESSAGE ON WIRE	STARTING POINT
YES	16	BLU	#984 WASHER PUMP GROUND	ENGINE BULK HEAD
YES	16	BLK/YLW	#983 WASHER PUMP POWER	ENGINE BULK HEAD

LEFT SIDE MARKER

PRINT	GAUGE	COLOR	PRINTED MESSAGE ON WIRE	STARTING POINT
NO	18	LTBLU	#926 FRONT LEFT TURN SIGNAL POWER	LEFT TURN SPLICE
YES	18	BRN	#927 PARK LIGHT POWER	PARK LIGHT SPLICE

LEFT HEADLAMP

PRINT	GAUGE	COLOR	PRINTED MESSAGE ON WIRE	STARTING POINT
NO	14	LTGRN	#908 HIGH BEAM POWER	HIGH BEAM SPLICE
NO	14	TAN	#909 LOW BEAM POWER	LOW BEAM SPLICE
NO	14	BLK	#969 HEADLAMP GROUND	FRONT LIGHTING GROUND SPLICE

GROUND

PRINT	GAUGE	COLOR	PRINTED MESSAGE ON WIRE	STARTING POINT
YES	14	BLK	#969 GROUND SOURCE (CORE SUPPORT)	FRONT LIGHTING GROUND SPLICE

LEFT TURN SIGNAL

PRINT	GAUGE	COLOR	PRINTED MESSAGE ON WIRE	STARTING POINT
YES	18	LTBLU	#926 FRONT LEFT TURN SIGNAL POWER	LEFT TURN SPLICE
YES	18	BRN	#927 PARK LIGHT POWER	PARK LIGHT SPLICE
YES	18	BLK	#969 TURN SIGNAL GROUND	FRONT LIGHTING GROUND SPLICE

HORNS

PRINT	GAUGE	COLOR	PRINTED MESSAGE ON WIRE	STARTING POINT
YES	16	GRN	#924 HORN POWER	HORN SPLICE
YES	16	GRN	#924 HORN POWER	HORN SPLICE

RIGHT TURN SIGNAL

PRINT	GAUGE	COLOR	PRINTED MESSAGE ON WIRE	STARTING POINT
NO	18	BLU	#925 FRONT RIGHT TURN SIGNAL POWER	RIGHT TURN SPLICE
YES	18	BRN	#927 PARK LIGHT POWER	PARK LIGHT SPLICE
NO	18	BLK	#969 TURN SIGNAL GROUND	FRONT LIGHTING GROUND SPLICE

RIGHT HEADLAMP

PRINT	GAUGE	COLOR	PRINTED MESSAGE ON WIRE	STARTING POINT
NO	14	LTGRN	#908 HIGH BEAM POWER	HIGH BEAM SPLICE
NO	14	TAN	#909 LOW BEAM POWER	LOW BEAM SPLICE
NO	14	BLK	#969 HEADLAMP GROUND	FRONT LIGHTING GROUND SPLICE

RIGHT SIDE MARKER

PRINT	GAUGE	COLOR	PRINTED MESSAGE ON WIRE	STARTING POINT
NO	18	BLU	#925 FRONT RIGHT TURN SIGNAL POWER	RIGHT TURN SPLICE
YES	18	BRN	#927 PARK LIGHT POWER	PARK LIGHT SPLICE

GROUND

PRINT	GAUGE	COLOR	PRINTED MESSAGE ON WIRE	STARTING POINT
YES	10	BLK	#969 BATTERY "-" / GROUND SOURCE	FRONT LIGHTING GROUND SPLICE

WIPER MOTOR

PRINT	GAUGE	COLOR	PRINTED MESSAGE ON WIRE	STARTING POINT
YES	16	LTBLU	#977 WIPER MOTOR (HIGH)	ENGINE BULK HEAD
YES	16	BK/YW	#982 WIPER MOTOR POWER	ENGINE BULK HEAD
YES	16	BLK	#979 WIPER MOTOR (LOW/PARK)	ENGINE BULK HEAD
NO	16	GRN	"FOR ALL DELAY SYSTEMS"	ENGINE BULKHEAD
NO	16	WHT	FOR 1977-1979 DELAY SYSTYEMS	ENGINE BULKHEAD

UNDER HOOD LIGHT**UNDERHOOD LIGHT**

PRINT	GAUGE	COLOR	PRINTED MESSAGE ON WIRE	STARTING POINT
YES	16	ORG	#971 UNDER HOOD LIGHT POWER	ENGINE BULKHEAD

ENGINE/IGNITION**COIL & GAUGE SENDERS**

PRINT	GAUGE	COLOR	PRINTED MESSAGE ON WIRE	STARTING POINT
YES	16	PK/BK	#920 COIL POWER ("+")	ENGINE BULK HEAD
YES	16	YLW	#970 IGNITION BYPASS (COIL "+" TO STARTER "I")	STARTER
YES	18	BRN	#923 TACH SIGNAL (COIL "-")	ENGINE BULK HEAD
YES	18	GRN	#921 COOLANT TEMPERATURE SIGNAL	ENGINE BULK HEAD
YES	18	BL/WT	#922 OIL PRESSURE SIGNAL	ENGINE BULK HEAD
YES	18	BLK	#969 OIL PRESSURE SWITCH GROUND	ENGINE BULKHEAD
YES	18	BLU	#954 CHOKE POWER	ENGINE BULK HEAD

START/CHARGE**ALTERNATOR**

PRINT	GAUGE	COLOR	PRINTED MESSAGE ON WIRE	STARTING POINT
NO	4	RED	* SECTION LABEL ON WIRE #915 ALTERNATOR OUTPUT	BATTERY + SPLICE
YES	14	RED	#995 ALTERNATOR BATTERY POWER SAMPLE	BATTERY + SPLICE
YES	16	BRN	#914 ALTERNATOR EXCITER	ENGINE BULK HEAD

MIDI FUSE

PRINT	GAUGE	COLOR	PRINTED MESSAGE ON WIRE	STARTING POINT
NO	4	RED	* SECTION LABEL ON WIRE #915 ALTERNATOR OUTPUT	BATTERY + SPLICE

STARTER

PRINT	GAUGE	COLOR	PRINTED MESSAGE ON WIRE	STARTING POINT
YES	12	PPL	#919 STARTER SOLENOID "S" (START SIGNAL)	ENGINE BULK HEAD
YES	16	YLW	#970 IGNITION BYPASS (COIL "+" TO STARTER "I")	COIL

INTERIOR HARNESS

DIMMER SWITCH

PRINT	GAUGE	COLOR	PRINTED MESSAGE ON WIRE	STARTING POINT
YES	14	LTBLU	#907 DIMMER SWITCH POWER	HEADLIGHT SWITCH
NO	14	TAN	#909 LOW BEAM POWER	INTERIOR BULKHEAD
NO	14	LTGRN	#908 HIGH BEAM POWER	INTERIOR BULKHEAD

E. BRAKE SWITCH

PRINT	GAUGE	COLOR	PRINTED MESSAGE ON WIRE	STARTING POINT
YES	18	TN/WT	#968 EMERGENCY BRAKE SWITCH	BRAKE WARN GROUND SPLICE

KEY BUZZER

PRINT	GAUGE	COLOR	PRINTED MESSAGE ON WIRE	STARTING POINT
YES	18	ORG	#903 KEY BUZZER POWER	ACCESSORY POWER SPLICE
YES	18	PK/BK	#999 KEY BUZZER GROUND	TURN SWITCH

SEAT BELT BUZZER

PRINT	GAUGE	COLOR	PRINTED MESSAGE ON WIRE	STARTING POINT
YES	18	PNK	#935 SEAT BELT RELAY POWER	GAUGE POWER SPLICE
YES	18	PK/WT	#942 SEAT BELT LIGHT POWER/ACTIVATION	SEAT BELT LIGHT
YES	16	BLK	#993 SEAT BELT GROUND SIGNAL	SEAT BELT
NO	18	BLK	#969 SEAT BELT BUZZER GROUND	INTERIOR GROUND SPLICE

POWER WINDOW

PRINT	GAUGE	COLOR	PRINTED MESSAGE ON WIRE	STARTING POINT
YES	14	PNK/BLK	#911 POWER WINDOW POWER SOURCE (IGN)	FUSE BLOCK

POWER LOCK

PRINT	GAUGE	COLOR	PRINTED MESSAGE ON WIRE	STARTING POINT
YES	14	ORG/BLK	#910 POWER LOCK POWER SOURCE (BATTERY)	FUSE BLOCK

DRVR. DOOR JAMB SWITCH

PRINT	GAUGE	COLOR	PRINTED MESSAGE ON WIRE	STARTING POINT
YES	16	WHT	#961 DRIVER DOOR JAMB SWITCH	COURT. LIGHT GROUND SPLICE
YES	18	BLK	#966 KEY BUZZER SIGNAL	TURN SWITCH

BRAKE SWITCH

PRINT	GAUGE	COLOR	PRINTED MESSAGE ON WIRE	STARTING POINT
YES	16	ORG	#917 BRAKE SWITCH POWER INPUT	FUSE BLOCK
NO	16	WHT	#918 BRAKE LIGHT POWER	BRAKE LIGHT POWER SPLICE

A/C & BLOWER SWITCH POWER

PRINT	GAUGE	COLOR	PRINTED MESSAGE ON WIRE	STARTING POINT
YES	14	BRN	#904 HEATER SWITCH POWER INPUT	FUSE BLOCK

PANEL LIGHT

PRINT	GAUGE	COLOR	PRINTED MESSAGE ON WIRE	STARTING POINT
YES	18	GRY	#930 PANEL LIGHT POWER	GAUGE LIGHT POWER SPLICE
NO	18	BLK	#969 PANEL LIGHT GROUND	INTERIOR GROUND SPLICE

GROUND

PRINT	GAUGE	COLOR	PRINTED MESSAGE ON WIRE	STARTING POINT
NO	10	BLK	#969 INTERIOR GROUND	INTERIOR GROUND SPLICE

COURTESY LIGHT

PRINT	GAUGE	COLOR	PRINTED MESSAGE ON WIRE	STARTING POINT
YES	18	ORG	#971 COURTESY LIGHT POWER	COURT. LIGHT POWER SPLICE
YES	18	WHT	#961 COURTESY LIGHT GROUND	COURT. LIGHT GROUND SPLICE

NEUTRAL SAFETY SWITCH

PRINT	GAUGE	COLOR	PRINTED MESSAGE ON WIRE	STARTING POINT
YES	12	PU/WT	#919 START SIGNAL (FROM IGN. SW. TO N. SAFETY)	IGNITION SWITCH
YES	12	PPL	#919 START SIGNAL TO STARTER	INTERIOR BULKHEAD

REVERSE SWITCH

PRINT	GAUGE	COLOR	PRINTED MESSAGE ON WIRE	STARTING POINT
YES	16	LTGRN	#956 REVERSE LIGHT POWER	TAIL SECTION
YES	16	PNK	#958 REVERSE SWITCH POWER INPUT	FUSE BLOCK

IGNITION SWITCH

PRINT	GAUGE	COLOR	PRINTED MESSAGE ON WIRE	STARTING POINT
YES	18	GRN	#921 ENGINE TEMP SIGNAL	INTERIOR BULKHEAD
YES	18	GRN	#921 ENGINE TEMP SIGNAL/TEST	GAUGE CLUSTER
NO	18	TN/WT	#968 EMERGENCY BRAKE SWITCH	BRAKE WARN GROUND SPLICE
YES	16	BN/WT	#914 ALTERNATOR EXCITER	GAUGE CLUSTER
YES	12	ORG	#933 SWITCHED (IGN) POWER TO FUSE BLOCK	FUSE BLOCK
PRINT	GAUGE	COLOR	PRINTED MESSAGE ON WIRE	STARTING POINT

YES	12	RED	#934 IGNITION SWITCH POWER	FUSE BLOCK
YES	16	PK/BK	#931 SWITCHED POWER TO "COIL" FUSE	FUSE BLOCK
YES	12	PU/WT	#919 START SIGNAL (FROM IGN. SW. TO N. SAFETY)	NEUTRAL SAFETY SWITCH
YES	12	RED	#934 IGNITION SWITCH POWER	FUSE BLOCK
YES	12	BRN	#932 ACCESSORY POWER	FUSE BLOCK

TURN SWITCH

PRINT	GAUGE	COLOR	PRINTED MESSAGE ON WIRE	STARTING POINT
YES	18	BLK	#966 KEY BUZZER SIGNAL	DRVR. DOOR JAMB SWITCH
YES	18	PK/BK	#999 KEY BUZZER GROUND	KEY BUZZER
YES	18	BLK	#963 HORN RELAY GROUND ACTIVATION	FUSE BLOCK- HORN RELAY
YES	16	LT.BLU	#926 FRONT LEFT TURN SIGNAL POWER	FRONT LEFT TURN POWER SPLICE
YES	16	BLU	#925 FRONT RIGHT TURN SIGNAL POWER	FRONT RIGHT TURN POWER SPLICE
YES	16	BRN	#951 HAZARD SWITCH POWER	FUSE BLOCK- HAZARD FLASHER
YES	16	PPL	#952 TURN SIGNAL SWITCH POWER	FUSE BLOCK-TURN FLASHER
YES	16	YLW	#949 REAR LEFT TURN SIGNAL POWER	TAIL SECTION
YES	16	GRN	#948 REAR RIGHT TURN SIGNAL POWER	TAIL SECTION
YES	16	WHT	#918 BRAKE SWITCH OUTPUT	BRAKE LIGHT POWER SPLICE

RADIO

PRINT	GAUGE	COLOR	PRINTED MESSAGE ON WIRE	STARTING POINT
YES	16	YLW	#940 RADIO BATTERY POWER (MEMORY)	FUSE BLOCK
YES	16	RED	#941 RADIO SWITCHED POWER	FUSE BLOCK
YES	16	BK/WT	#969 RADIO GROUND	INTERIOR GROUND SPLICE
YES	18	GRY	#930 RADIO BACKLIGHT DIM	GAUGE LIGHT POWER SPLICE

CIG. LIGHTER

PRINT	GAUGE	COLOR	PRINTED MESSAGE ON WIRE	STARTING POINT
YES	16	ORG	#903 CIGARETTE LIGHTER POWER	ACCESSORY POWER SPLICE
YES	16	BLK	#969 CIGARETTE LIGHTER GROUND	INTERIOR GROUND SPLICE

CLOCK

PRINT	GAUGE	COLOR	PRINTED MESSAGE ON WIRE	STARTING POINT
YES	18	ORG	#965 CLOCK POWER	ACCESSORY POWER SPLICE
YES	18	BLK	#969 CLOCK GROUND	INTERIOR GROUND SPLICE

GAUGE CLUSTER

PRINT	GAUGE	COLOR	PRINTED MESSAGE ON WIRE	STARTING POINT
YES	16	BLK	#969 INSTRUMENT GLUSTER GROUND	INTERIOR GROUND SPLICE
YES	18	GRY	#930 GAUGE LIGHT POWER	GAUGE LIGHT POWER SPLICE
YES	18	TAN	#939 FUEL LEVEL SIGNAL	FUEL SENDER SPLICE
YES	18	PNK	#935 GAUGE POWER	GAUGE POWER SPLICE
YES	18	PNK	#935 GAUGE POWER	GAUGE POWER SPLICE
YES	18	GRN	#921 ENGINE TEMP SIGNAL/TEST	IGNITION SWITCH
YES	18	BRN	#923 TACH SIGNAL	INTERIOR BULKHEAD
YES	18	TN/WT	#968 LOW BRAKE SIGNAL	BRAKE WARN GROUND SPLICE
YES	18	LT.BLU	#937 LEFT TURN INDICATOR	FRONT L. TURN POWER SPLICE
YES	18	BLU	#938 RIGHT TURN INDICATOR	FRONT R. TURN POWER SPLICE
YES	18	LTGRN	#936 HIGH BEAM INDICATOR POWER	HIGH BEAM POWER SPLICE
YES	18	BL/WT	#922 OIL PRESSURE SIGNAL	INTERIOR BULKHEAD
YES	16	BN/WT	#914 ALT. EXCITER/CHARGE INDICATOR	INTERIOR BULKHEAD
YES	16	BN/WT	#914 ALTERNATOR EXCITER	IGNITION SWITCH

VOLTMETER

PRINT	GAUGE	COLOR	PRINTED MESSAGE ON WIRE	STARTING POINT
YES	18	PNK	#935 VOLTMETER POWER	GAUGE POWER SPLICE

HEADLIGHT SWITCH

PRINT	GAUGE	COLOR	PRINTED MESSAGE ON WIRE	STARTING POINT
YES	14	BLK	#969 HEADLIGHT SWITCH GROUND	INTERIOR GROUND SPLICE
YES	14	ORG	#959 HEADLIGHT SWITCH POWER (PARK/TAIL)	FUSE BLOCK
YES	16	BRN	#927 PARK LIGHT POWER	PARK LIGHT POWER SPLICE
YES	14	LTBLU	#907 DIMMER SWITCH POWER	DIMMER SWITCH
YES	16	GRN	#930 POWER TO GAUGE/PANEL LIGHTS	GAUGE LIGHT POWER SPLICE
YES	14	RED	#928 HEADLIGHT SWITCH POWER (HEADLIGHTS)	FUSE BLOCK
YES	16	WHT	#961 DOME LIGHT GROUND (ACTIVATION)	COURT. LIGHT GROUND SPLICE

WIPER SWITCH

PRINT	GAUGE	COLOR	PRINTED MESSAGE ON WIRE	STARTING POINT
YES	16	BLU	#984 WASHER PUMP GROUND ACTIVATION	INTERIOR BULKHEAD
YES	16	LT.BLU	#979 WIPER SWITCH (LOW)	INTERIOR BULKHEAD
YES	16	BLK	#977 WIPER SWITCH (HIGH)	INTERIOR BULKHEAD
PRINT	GAUGE	COLOR	PRINTED MESSAGE ON WIRE	STARTING POINT

YES	16	BLK	#969 WIPER SWITCH GROUND	INTERIOR GROUND SPLICE
YES	16	GRN	"FOR ALL DELAY SYSTEMS"	INTERIOR BULKHEAD
YES	16	WHT	"FOR 1977-1979 DELAY SYSTYEMS"	INTERIOR BULKHEAD
YES	16	ORG	"FOR 1977-1979 DELAY SYSTYEMS (IGN. POWER)"	INTERIOR BULKHEAD

PANEL LIGHT

PRINT	GAUGE	COLOR	PRINTED MESSAGE ON WIRE	STARTING POINT
YES	18	GRY	#930 PANEL LIGHT POWER	GAUGE LIGHT POWER SPLICE
YES	18	BLK	#969 PANEL LIGHT GROUND	INTERIOR GROUND SPLICE

AFTERMARKET GAUGES

PRINT	GAUGE	COLOR	PRINTED MESSAGE ON WIRE	STARTING POINT
YES	16	PNK	#935 AFTERMARKET GAUGE POWER	GAUGE POWER SPLICE
YES	16	GRY	#930 AFTERMARKET GAUGE LIGHT POWER	GAUGE LIGHT POWER SPLICE
YES	16	BLK	#969 AFTERMARKET GAUGE GROUND	INTERIOR GROUND SPLICE
YES	18	TAN	#939 FUEL LEVEL SIGNAL	FUEL SENDER SPLICE
YES	18	GRN	#921 ENGINE TEMP SIGNAL	INTERIOR BULKHEAD
YES	18	BRN	#923 TACH SIGNAL	INTERIOR BULKHEAD
YES	18	BLU/WHT	#922 OIL PRESSURE SIGNAL	INTERIOR BULKHEAD
YES	16	BLK	#969 GAUGE LIGHT GROUND	INTERIOR GROUND SPLICE

GEAR INDICATOR LIGHT

PRINT	GAUGE	COLOR	PRINTED MESSAGE ON WIRE	STARTING POINT
YES	18	GRY	#930 GEAR INDICATOR LIGHT POWER	GAUGE LIGHT POWER SPLICE
YES	18	BLK	#969 GEAR INDICATOR GROUND	INTERIOR GROUND SPLICE

COURTESY LIGHT

PRINT	GAUGE	COLOR	PRINTED MESSAGE ON WIRE	STARTING POINT
YES	18	ORG	#971 COURTESY LIGHT POWER	COURT. LIGHT POWER SPLICE
YES	18	WHT	#961 COURTESY LIGHT GROUND	COURT. LIGHT GROUND SPLICE

SEAT BELT LIGHT

PRINT	GAUGE	COLOR	PRINTED MESSAGE ON WIRE	STARTING POINT
YES	18	PK/WT	#942 SEAT BELT LIGHT POWER/ACTIVATION	SEAT BELT BUZZER
YES	18	BLK	#969 SEAT BELT LIGHT GROUND	INTERIOR GROUND SPLICE

GLOVE BOX SWITCH

PRINT	GAUGE	COLOR	PRINTED MESSAGE ON WIRE	STARTING POINT
YES	18	BLK	#969 GLOVE BOX SWITCH GROUND	INTERIOR GROUND SPLICE

GLOVE BOX LIGHT

PRINT	GAUGE	COLOR	PRINTED MESSAGE ON WIRE	STARTING POINT
YES	18	ORG	#971 GLOVE BOX LIGHT POWER	COURT. LIGHT POWER SPLICE

PASS. DOOR JAMB SWITCH

PRINT	GAUGE	COLOR	PRINTED MESSAGE ON WIRE	STARTING POINT
YES	16	WHT	#961 PASS. DOOR JAMB SWITCH	COURT. LIGHT GROUND SPLICE

SEAT BELT

PRINT	GAUGE	COLOR	PRINTED MESSAGE ON WIRE	STARTING POINT
YES	16	BLK	#993 SEAT BELT GROUND SIGNAL	SEAT BELT BUZZER
YES	18	BLK	#969 SEAT BELT GROUND	INTERIOR GROUND SPLICE

TAIL SECTION

DOME LIGHT

PRINT	GAUGE	COLOR	PRINTED MESSAGE ON WIRE	STARTING POINT
YES	18	ORG	#971 DOME LIGHT POWER	FUSE BLOCK
YES	18	WHT	#961 DOME LIGHT GROUND	COURT. LIGHT GROUND SPLICE

FUEL PUMP

PRINT	GAUGE	COLOR	PRINTED MESSAGE ON WIRE	STARTING POINT
YES	14	PNK	#947 FUEL PUMP POWER	FUSE BLOCK

TAIL HARNESS

PRINT	GAUGE	COLOR	PRINTED MESSAGE ON WIRE	STARTING POINT
YES	16	YLW	#949 REAR LEFT TURN SIGNAL POWER	TURN SWITCH
YES	16	GRN	#948 REAR RIGHT TURN SIGNAL POWER	TURN SWITCH
YES	16	LTBLU	#918 BRAKE LIGHT POWER	BRAKE LIGHT POWER SPLICE
YES	18	TAN	#939 FUEL LEVEL SIGNAL	FUEL SENDER SPLICE
YES	14	BLK	#969 GROUND SUPPLY TO REAR LIGHTS	INTERIOR GROUND SPLICE
YES	16	BRN	#927 TAIL LIGHT POWER	PARK LIGHT POWER SPLICE
YES	16	LTGRN	#956 REVERSE LIGHT POWER	REVERSE SWITCH

Painless Performance Products, LLC
Limited Warranty and Return Policy

Chassis harnesses, fuel injection harnesses, and Trail Rocker units are covered under a lifetime warranty.

All other products manufactured and/or sold by Painless Performance are warranted to the original purchaser to be free from defects in material and workmanship under normal use. Painless Performance will repair or replace defective products without charge during the first 12 months from the purchase date. No products will be considered for warranty without a copy of the purchase receipt showing the sellers name, address, and date of purchase. You must return the product to the dealer you purchased it from to initiate warranty procedures.

Painless Performance Products LLC
2501 Ludelle Street
Fort Worth, TX 76105
Phone (817) 244-6212