

PAINLESS[®]

PERFORMANCE PRODUCTS

Wire Harness Installation

Instructions

Manual #90585

For Installing:

**#20128 Direct Fit 1968 Chevelle/Malibu
26 Circuit Chassis Harness**



Painless Performance Products recommends you, the installer, read this installation manual from front to back before installing this harness and removal of the current harness installed in your vehicle. Due to the variables in modifications that can be done to a Chevelle/Malibu, reading this manual will give you considerable insight on the proper installation of this harness.



Perfect Performance Products, LLC

Painless Performance Products Division

2501 Ludelle Street

Fort Worth, TX 76105-1036

800-423-9696 phone – 817-244-4024 fax

Web Site: www.painlessperformance.com

E-Mail: painless@painlessperformance.com

If you have any questions concerning the installation of this harness or having trouble in general, feel free to call Painless Performance Products' tech line at 1-800-423-9696. Calls are answered from 8am to 5pm central time, Monday thru Friday, except holidays.

We have attempted to provide you with as accurate instructions as possible, and are always concerned about corrections or improvements that can be made. If you have found any errors or omissions, or if you simply have comments or suggestions concerning these instructions, please write us at the address above, send us a fax at (817) 244-4024 or e-mail us at painless@painlessperformance.com. We sincerely appreciate your business.

Perfect Performance Products, LLC shall in no event be liable in contract or tort (including negligence) for special, indirect, incidental, or consequential damages, such as but not limited to, loss of property damage, or any other damages, costs or expenses which might be claimed as the result of the use or failure of the goods sold hereby, except only the cost of repair or replacement.

Cover photo courtesy of RK MOTORS Charlotte, NC

Installation Manual #90585

1st Edition: AUGUST, 2015

Copyright © 2015 by Perfect Performance Products, LLC

CAUTION: BEFORE THE REMOVAL OF YOUR ORIGINAL HARNESS AND/OR THE INSTALL OF YOUR NEW PAINLESS HARNESS, DISCONNECT THE POWER FROM YOUR VEHICLE BY REMOVING THE NEGATIVE OR POSITIVE BATTERY CABLE FROM THE BATTERY. THE BATTERY IS NOT TO BE CONNECTED UNTIL THE PAINLESS HARNESS HAS BEEN COMPLETELY INSTALLED AND TESTED.

- A full color copy of these instructions can be found online at <http://www.painlessperformance.com/InfoSearch/manuals.php>
- If your vehicle has an existing harness, you will want to retain it for the possible re-use of various pigtails & connector housings particular to your application. During the removal process, avoid making any unnecessary cuts. The entire harness should be able to be removed without making any cuts. Included in this kit is a sheet of pre-printed labels, to assist in identifying connections as the existing harness is removed from the vehicle. Place these labels on your factory harness accordingly as you disconnect it from the vehicle.

This harness does NOT contain any A/C wiring or power window/power lock wires. It does include the power wires for the A/C switch, PW & PL options. Do not remove the power window/lock or A/C harness from the vehicle if you have these options and plan on retaining these features.

This harness also does not include the wiring for the TCS relay for turbo 400 transmissions, rear defrost, wiring for a convertible top, and also does not support ammeters found on Super Sport gauges. The ammeter worked based on the resistance of the factory 10 gauge wiring found going to the core support mounted horn relay and a small junction box mounted behind the battery, all of which has been removed with the install of this new Painless harness.

- During the removal of the original harness, it is a good idea to document how the original harness is routed as this Painless harness follows most of the same routing.
- If you do not have an existing harness, the package of terminals included with the harness will enable you to make most of the connections needed that aren't already provided on the harness.
- Only printed wires will have a 900-series number. These 900-series numbers are used to identify various wires and circuits in the wiring diagrams that are a part of these instructions.
- **In the event that there are unused or unconnected wires, the ends of all wires labeled in this instruction manual as "POWER" will need to have the ends terminated with an insulated terminal or taped. Doing so will prevent the wires shorting and causing harness failure or fire.**

TABLE OF CONTENTS

<u>PAGE #</u>	<u>SECTION</u>
7	<u>INTRODUCTION</u>
8	<u>CONTENTS OF THE PAINLESS WIRE HARNESS KIT</u>
9	<u>SMALL PARTS</u>
10	<u>TOOLS NEEDED</u>
12	<u>INSTALLING FACTORY TERMINALS & UNPINNING CONNECTORS</u>
14	<u>PRE-INSTALLATION GUIDELINES</u>
15	<u>GROUNDS</u>
22	<u>FUSE BLOCK MOUNTING</u>
21	<u>FACTORY HARNESS REMOVAL</u>
22	<u>FUSE BLOCK MOUNTING</u>
24	<u>ENGINE HARNESS</u>
27	LIGHT SECTION
	Brake Switch
28	Left Side Marker
29	Left Headlight
30	Left High Beam
31	Left Turn/Park Light
32	Horn(s)
33	Right turn/Park Light, Right High Beam, Right Headlight, Right Marker Light
	Ground
35	ENGINE HARNESS ROUTING
36	Wiper Motor
37	Washer Pump
38	ENGINE SECTION
	Coolant Temp
39	Oil Pressure
	Electric Choke
40	COIL/IGNITION SECTION
	Coil Power
41	Ignition Bypass
42	HEI & Resisted Coils
43	Aftermarket Ignition Boxes
44	Fuel Injection
	Tachometer
45	ALTERNATOR SECTION
	Alternator
47	One Wire Alternator
48	10-SI Alternator
49	CS-130 Alternator
50	CS-130D Alternator
52	External Regulator
53	MIDI Fuse
54	STARTER SECTION
57	Blower motor
58	<u>INTERIOR HARNESS</u>
59	Dimmer Switch

TABLE OF CONTENTS continued

<u>PAGE #</u>	<u>SECTION</u>
60	Emergency Brake Switch
61	ACCESSORY SECTION
	Power Window
	Power Lock
63	Fuel Pump
	Driver Door Jamb Switch
65	Driver Courtesy Light
67	Brake Switch
68	Turn Signal Switch
71	Neutral Safety/Clutch Switch
72	Reverse Switch
73	Console
	CONSOLE HARNESS
78	Interior Ground
79	Aftermarket Gauges- under dash, not cluster
84	Heater Switch
85	Heater Only Harness
87	Heater Panel Light
88	Passenger Courtesy Light
89	Glove Box Switch
90	Passenger Door Jamb Switch
91	Gauge Cluster Harness
92	Factory Indicator Cluster
93	Factory SS Cluster
97	Wiper Switch & Wiper Switch Ground
99	Headlight Switch
101	Gauge Cluster Connection
103	Ignition Switch
105	Cigarette Lighter/Power Port
106	Radio
108	Tail Section Connector
	TAIL HARNESS
111	Dome Light
113	Trunk Light
114	Left Turn/Brake/Tail
115	Ground
116	Driver Reverse Light
118	Fuel Sending Unit
119	License Plate Light
	Passenger Reverse Light
120	Ground
121	Right Turn/Brake/Tail
122	TESTING THE SYSTEM
124	WIRE INDEX

SCHEMATICS and DRAWINGS

<u>PAGE #</u>	<u>TITLE</u>
17	GROUND SCHEMATIC
34	FRONT LIGHTING SCHEMATIC
41	BALLAST RESISTOR CONNECTION
42	HEI CONNECTIONS
	NO RESISTOR COIL CONNECTIONS
43	MSD CONNECTIONS
48	10-S1 ALTERNATOR
49	CS-130 ALTERNATOR
51	CS-130D ALTERNATOR
52	EXTERNAL VOLTAGE REGULATOR
55	CHARGE/BATTERY POWER SCHEMATIC
56	STARTER SCHEMATIC
66	COURTESY/DOME LIGHT SCHEMATIC
69	TURN SIGNAL SWITCH SCHEMATIC
80	AFTERMARKET GAUGE CONNECTOR
81	POWERING AFTERMARKET GAUGES
82	GROUNDING AFTERMARKET GAUGES
83	AFTERMARKET GAUGE LIGHT POWER
	AFTERMARKET GAUGE SENDER WIRES
86	HEATER ONLY SCHEMATIC
94	AFTERMARKET IN CLUSTER TACHOMETER
98	WIPER SWITCH SCHEMATIC
100	HEADLIGHT SWITCH SCHEMATIC
102	GAUGE CLUSTER SCHEMATIC
104	IGNITION SWITCH SCHEMATIC
107	ACCESSORY SCHEMATIC
110	TAIL HARNESS SCHEMATIC

INTRODUCTION

Thank you for your purchase of a Painless Performance product. These instructions, as well as the Painless harness itself, have been designed to allow you, the installer, the cleanest and easiest install possible.

Do not let the length of this instruction manual intimidate you. Much of the information contained in this manual is just helpful information about each wire, where the wire comes from, where it goes, why a component needs it, etc. You will find that the actual install portions of this manual are pretty straight forward and easy to follow.

- The install portions are noted with a round bullet note, as seen here.

Individual components and sections of the harness are labeled with printed tags for easy identification. The colors used in this harness are the most common colors GM used during the production of these Chevelles/Malibus. In some instances, a wire color may not match your factory color. This is because the colors were not exactly uniform throughout this time frame. In most cases it was a simple stripe color change. These colors, along with the schematic diagrams found throughout this manual, will help you identify the different circuits during installation and later on if additions to the overall system are necessary.

The complete wiring harness, as well as this instruction manual, have been designed with 3 harnesses incorporated into it:

ENGINE HARNESS, INTERIOR HARNESS, TAIL HARNESS

With the many options provided by Chevrolet and with so many variables in modifications that can be done to a Chevelle/Malibu, there may be wires and pre-installed connectors that are not needed in your specific application. Harness routing may also differ according to your model or use of aftermarket components such as gauges, shifters, steering column, etc.

During the course of reading this manual you will notice wire colors with a slash, as an example: Black/White. This indicates a wire with a stripe. The first color is the main color of the wire and the color after the slash is the stripe color. In the case of the example, Black/White indicates a black wire with a white stripe.

On many wires you will find a printed 900 series circuit number and text describing the wires function. These 900 series numbers are complete random numbers Painless assigned to these wires and have nothing to do with any factory circuit designations or any numbers you may find on a factory schematic. In some cases you will see multiple wires with the same number, such as ground wires. There will be multiple #969 GROUND wires throughout this harness since they all belong to the same circuit. Other wires, such as something like the electric choke, wire #954, will only appear once. The wiring index in the back of the manual will list the print on all the wires if for some reason you find the print illegible or hard to read. You will also notice some wires will not have any print at all, these wires are either too short or the gauge of the wire is too large or small for our equipment to print on. In such cases, like the red charge wire #915, important wires will have print applied to a white tag like the section labels.

CONTENTS OF THE PAINLESS WIRE HARNESS KIT

Refer to the **Contents Figure** (below) to take inventory. See that you have everything you're intended to have in this kit. If you find that anything is missing or damaged, please contact the dealer where you obtained the kit or Painless Performance at (800) 423-9696.

The Painless Wire Harness Kit should contain the following:

- 1) Main Wire Harness, with the fuse block and interior bulkhead
- 2) Engine wire harness, with the firewall bulkhead
- 3) Tail section harness, with the appropriate year range label for your particular vehicle
- 4) Console Harness
- 5) "#915 Charge Wire & Ballast Bypass" bag kit
- 6) Heater Only Harness
- 7) Gauge Cluster Harness
- 8) Zip tie & bulbs bag kit
- 9) "Alternator" bag kit
- 10) Turn Signal Switch Pigtails
- 11) Parts Kit: loose piece terminals, connectors, spare fuses, etc.

Not Pictured: Grease and installation manual



CONTENT FIGURE- All of the parts in the Painless kit

SMALL PARTS

Included with the Painless harness is one parts kit containing miscellaneous insulated terminals, fuses, screws, and nuts. The terminals that have a semi-transparent insulation are heat shrinkable to provide a weatherproof connection. These terminals include disconnect, ring, and splice terminals and have been provided for engine bay connections.

This parts kit also contains non insulated, factory style terminals. This kit will help make factory style connections to things like the sending units on the engine, alternator, ignition system, and other things that are not pre-terminated on this harness. A pair of roll over crimpers will be needed, as seen on the next page, to allow proper installation of these terminals. Proper use of this crimper and installation of these terminals can be found on [page 12](#).

One small bag kit, labeled “Alternator”, contains all of the components for an inline fuse installation and alternator connections. This fuse is to isolate the battery from the alternator and Painless harness. These parts include the base with cover, fuse, mounting screws and ring terminals. [Page 44](#) will go into detail about this bag.

The last of the small parts includes a larger bag with zip ties, bulbs, and different connectors. These connectors will be used throughout the install for things such as turn signal switch, after market gauges under the dash.



Parts in the Painless kit

TOOLS NEEDED

In addition to your regular hand tools, you will need, at least, the following tools:

Wire Crimping and Stripping Tools:

This style of hand crimper can be purchased from just about any local auto parts store, home improvement store or can also be purchased online. You will need this style of crimper to crimp the insulated terminals included in the small parts kit.

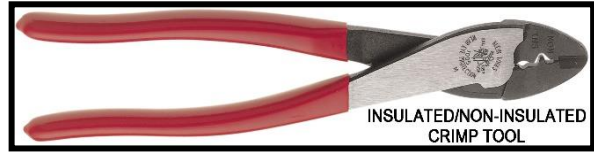

Another style of crimpers are “Jaw Crimpers” or “Roll Over Crimpers”. These crimpers will crimp factory style, un-insulated terminals. These types of terminals are provided in the kit for connections to an HEI distributor, engine compartment bulkhead and factory style alternator, etc. If none can be found locally, these crimpers can be found using Painless part #70900.

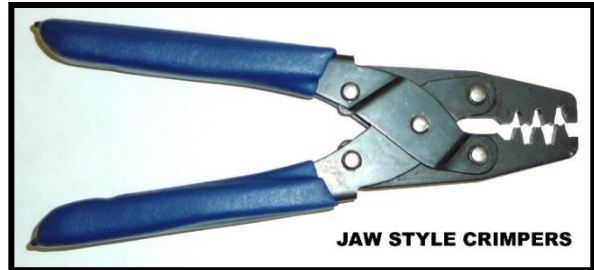

A good set of wire strippers are required to strip wire properly. This style of wire stripper is ideal for this harness install because of its ability to properly strip wire gauges 10 to 20. These are available from just about any local auto part store, electrical supply shop, home improvement store or can be purchased online.



Volt/Ohm Meter:

A Volt/Ohm meter is always a good tool to have on hand when installing any type of electrical components into any vehicle. Most basic units provide the two functions required to diagnose electrical issues seen during a harness install. These two functions are the ability to read DC Voltage and electrical continuity or Ohms. They can be purchased from any home improvement store, local hardware store and electrical supply shop and online.



Electric Drill & Bits:

A drill and bits are needed in order to use the screws provided with the kit for the MIDI fuse holder and the fuse block mounting.

Heat Gun:

Very useful to shrink the heat-shrinkable terminals found in the parts kit.

- **Small (10 amp or less) Battery Charger**

See **TESTING THE SYSTEM** located on page 117.

- **Factory Wire Schematic**

This isn't absolutely necessary; however, having one handy is good practice with any electrical job. Clymer and Haynes manuals, which can be found at most auto parts stores and online, usually contain these schematics.



INSTALLING FACTORY STYLE TERMINALS & UNPINNING CONNECTORS

Some of the terminals provided in the parts kit that allow for a factory style connection require “Roll Over” crimpers to be installed properly. These terminals are for connections that do not come pre-installed on the Painless harness or for modifying connections already made that must be changed to adapt to your particular installation.

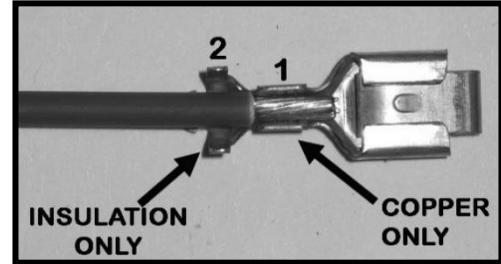

- Strip about $\frac{1}{4}$ " of insulation off of the wire.
- Insert the wire into the terminal. There are 2 terminal straps on the terminal. For instructional purposes, we will label them 1 and 2. Strap 1 crimps the exposed copper strands of the wire, while strap 2 crimps the wire insulation. Make sure your strip length is long enough to ensure only copper strands are crimped by Strap 1, but make sure it is short enough that only insulation is crimped by Strap 2. The photo to the right best demonstrates this.



- Strap 1 and Strap 2 will require two different jaws or openings in the crimper. The appropriate jaw depends on the wire gauge as well as the terminal stiffness. If you are unsure which jaw to use, you can always start with the biggest and work your way down until you get a tight crimp. After doing a few crimps, you will get a feel for which jaw a terminal/wire gauge requires for the best results.

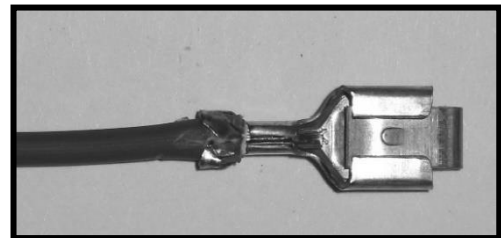

- With Strap 1 crimped you can move onto crimping the insulation strap, Strap 2. Place Strap 2 into the appropriate jaw of the crimpers. This jaw will be larger than the one used to crimp the first strap. Slowly crimp down on Strap 2 making sure the strap folds downward into the wire, and not overlapping itself, refer to the drawing below. Overlapping could cause problems with the terminal fitting into the intended connector.

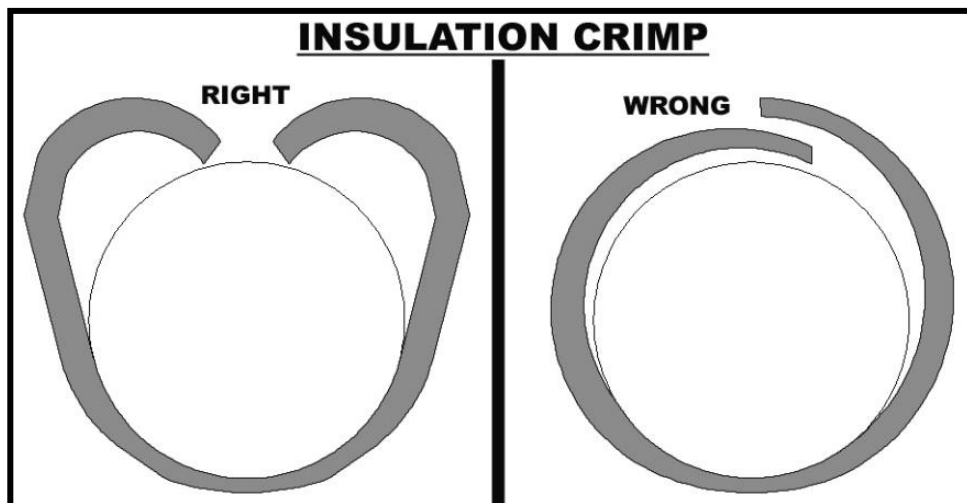

TO REMOVE A TERMINAL



- Locate the tang access slot on the terminal end of the connector. Push a paper clip/stiff wire or a small jeweler's flat head screwdriver into the slot to depress the locking tang of the terminal.
- Once depressed, pull the harness wire from the connector. Do not pull too hard or you could pull the wire from the terminal, leaving the terminal stuck in the connector.

PRE-INSTALLATION GUIDELINES

The installation of your wire harness mainly consists of two parts:

- The physical routing and securing of the wire harness, wires, and groups.
- The proper connection of the individual circuits.

These two major tasks are not separate steps, but are integrated together. That is, you will route some wires and make some connections, route more wires and make more connections. This Painless harness follows much of the same routing the factory harness did. Harness routing also may differ according to your year model or use of aftermarket components such as gauges, shifters, steering column, engine driven accessory brackets, etc. Harness routing also depends a great deal as the extent you want to secure and conceal the harness. This aspect will be more prominent in the ENGINE SECTION wiring, where some of the harness is visible.

The best pre-installation practice is to become familiar with the harness by locating each of the harness sections. A good way to do this is by laying out the wire harness on the floor and identifying each of the section labels found on the harnesses you read through the manuals. The wire index in the back of the manual will help to quickly identify each wire in these sections.

During this familiarization process, you will be able to add or remove wires your particular install may or may not need. Wires that may be removed are outlined throughout this manual; another good reason to read this manual in its entirety before any actual installation takes place.

During the familiarization process and during the install, wires should be bundled into groups. Use nylon ties, split loom, or tape. Exposed wires of the engine compartment and wires running in the rear of the vehicles may need some sort of wiring loom or covering.

Painless offers Power Braid Kit part #70920 and Classic Braid Kit part #70970 to fill this need. See the insert card that came with your wire harness for details.



GROUNDS

Throughout this instruction manual and when looking at the Painless harness you will see the word GROUND, maybe you've seen the ground symbol on wire diagrams? What exactly is a ground and why do you need it?

You've probably noticed the large cable coming from the negative side of your battery going down to the frame or to the engine. This cable allows voltage to get back to the battery through the metal of the frame and all the other metal pieces bolted to the frame. It is also important to have ground cables/straps going from the frame to the engine and from the frame to the body. Painless offers part [#40140](#), seen in the photo, to supply proper grounds back to the battery.

A ground is simply the common path voltage takes back to the battery. A ground, or chassis ground as it is often called, is any bare metal surface found on the vehicle which is in turn connected back to the frame through mounting points and ground straps. They are needed in order for the voltage current to have some place to go.

There are two ways components are grounded in the Chevelle/Malibu: through mounting and through wire connection. Some grounds on the Chevelle/Malibus are grounded through the mounting of the metal housings in which the bulbs are installed, like the front turn signals. Components such as the headlights, tail lights, radio, and gauge cluster all get their grounds through wires from the chassis harness, which are attached to ground sources which you will find in the harness.

To help avoid grounding problems, all the ground wires in the Painless harness are connected together through a series of splices. All of these splices connect to large 10 gauge wires in the engine compartment and in the trunk to allow a ground connection directly to the battery depending on the battery location. Ground wires are also present where the factory had them installed: 2 on the front core support for each headlamp and turn signals, 1 on the interior behind the Gauge cluster, and 1 in the trunk. The [Ground Schematic](#) on [page 15](#) has been provided to show you exactly which wires of the Painless harness are part of the integrated ground circuit.

On light housings that ground through the mounting, and for the harness ground wire connection points, make sure that all mounting points are clean by removing all dirt, corrosion, or paint. This is especially important for cars that have just been painted as paint build up will cause grounding issues. Course sandpaper should be all that's needed to properly clean grounding points.

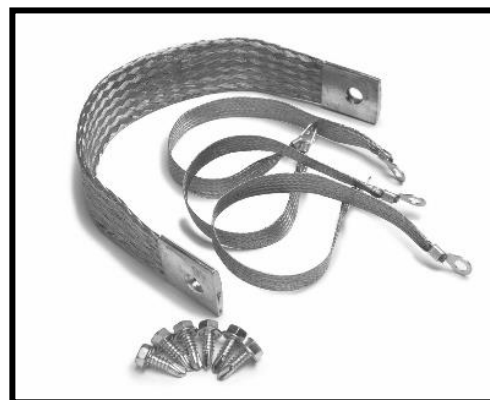

Why are clean grounds important?

As an example, we will use a park light bulb, like the front park lights on the Chevelle/Malibu which have turn signal and park light functions. Follow the red line from right to left in the diagrams on the next page. This red line indicates the path electrical current takes when everything is properly grounded and as represented in the second diagram, when the ground is bad; notice which bulbs illuminate, the yellow bulbs, when good and bad grounds are present.

In our park light example with a good ground source, current travels from the headlight switch when it is pulled to the "ON" position to the park light bulb. Since the bulb is properly grounded, current passes cleanly through the bulb causing it to illuminate and the current exits the bulb through the ground source back to the battery. The ground allows everything to work properly without any issues.

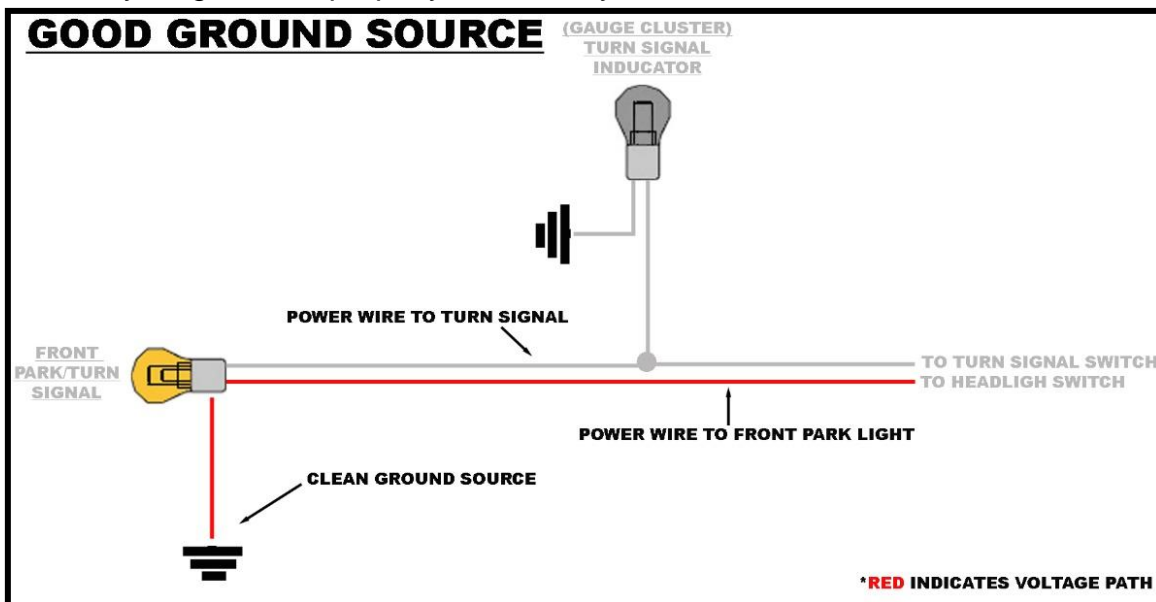

When a ground isn't connected or is contaminated with dirt, corrosion, or paint, the voltage will find the easiest path to ground, which is represented in the diagram below.

Current travels from the headlight switch to the park light bulb, but wait; there is no ground at the bulb. Since the ground it would normally use is not there, the current will find another way to get to ground and back to the battery. When this happens, things that should not have power receive power coming from the park light bulb. Since the turn signal wire also goes to the bulb, the current will travel out of the bulb through the turn signal wire. Notice in the diagram that a bad ground at the front park light can cause issues on the interior of the vehicle at the turn signal indicator on the dash. In this case, the turn signal indicator light is illuminated when it shouldn't be. Also, since this one power source which was only supposed to power 1 bulb is not powering 2 bulbs, both bulbs may be dimmer than they would have been if everything was grounded properly. This is one of the problems with diagnosing a bad ground; they can cause issues throughout the entire vehicle until a clean ground source is reached.

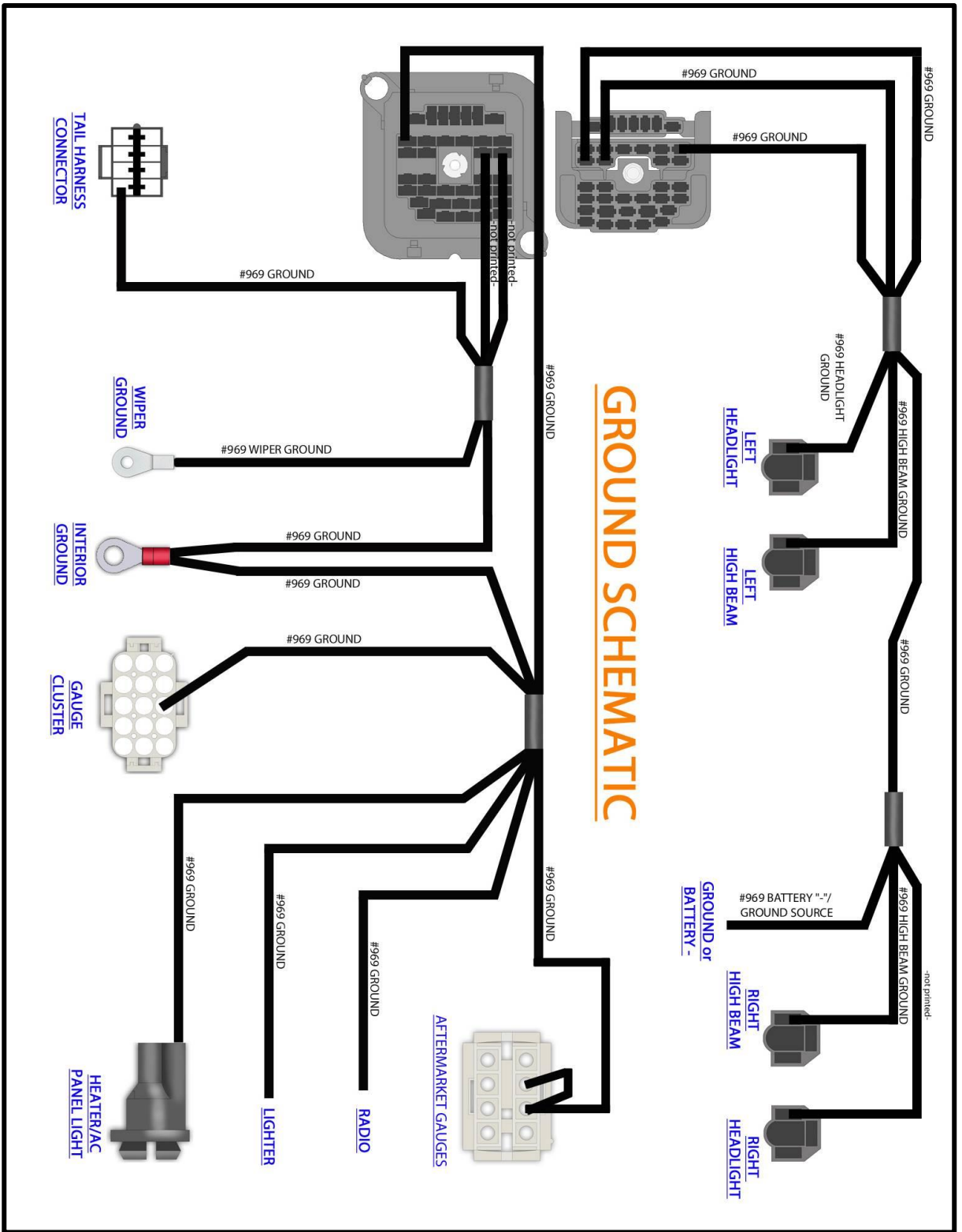

FUSE BLOCK

The Painless harness contains an 18 fuse GM style fuse block with the same mounting pattern as the factory installed fuse block. One big difference you will notice, outside of the additional circuits, is the larger fuse block uses modern ATC blade style fuses. This fuse block allows the convenience of having both flashers (turn signal and hazard), as well as the horn relay, to be mounted in one location.

Horn Relay

On the fuse block you will find a horn relay, which replaces the factory core support mounted horn relay. The fuse block mounted horn relay uses a standard 30 amp SPST relay. Replacement relays for the horn relay can be found at any auto parts store or by ordering [Painless part number #80131](#).

Flashers

The two flashers simply switch power off and on going to the turn signal switch and hazard switch. The flasher found in the top left corner is the hazard flasher. The flasher on the bottom right corner is the turn flasher.

How a flasher functions is simple. Power is switched off and on according to heat built in the resistance wire inside the flasher. As soon as power is drawn through the flasher, as when the turn signal or hazard switch is activated, the resistance wire heats up causing a spring metal strip to make contact with the output side of the flasher. This contact passes power through the flasher, into the switch and to the turn signal lamp(s). Once this contact has been made, the resistance wire is no longer resisting any current, so it begins to cool; this cooling causes the flasher to lose contact.

This loss of contact means that there is no longer any voltage going to the switch, causing the turn signal light to turn off. Once contact is lost, the resistance wire begins heating up and the entire process starts over again until the turn signal switch or hazard switch is disengaged.

Some L.E.D. turn signals do not draw enough current to activate a typical thermal flasher. If you are using L.E.D. turn signals, and your turn signals do not work properly, like staying on and not blinking or blinking too fast, and you are certain everything is connected properly, a no load flasher will be required; [Painless offers part number #80230 to fill this need](#).

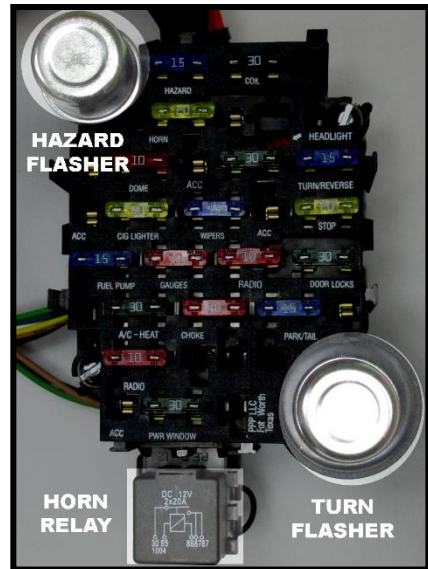
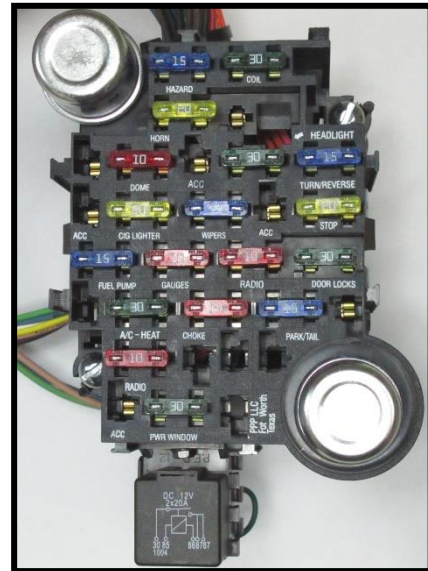

Accessory Ports

You will notice single ports on the fuse block, many of these are labeled “ACC”. These ports will give you access to battery power and switched IGN power to extra circuits you may need now or in the future. You will need to test the ports or refer to the diagram, at right, in order to tell which ports have battery power and which have switched power.

Terminals and connectors have been provided in the parts kit to allow you to tap into these extra sources, seen below. **The ports are all unfused power sources and must have an inline fuse, no larger than 15 amps, installed before being routed to a component needing power.** Anything needing more than 15 amps will need to have a relay installed. See relay wiring and activation on the next page for details.

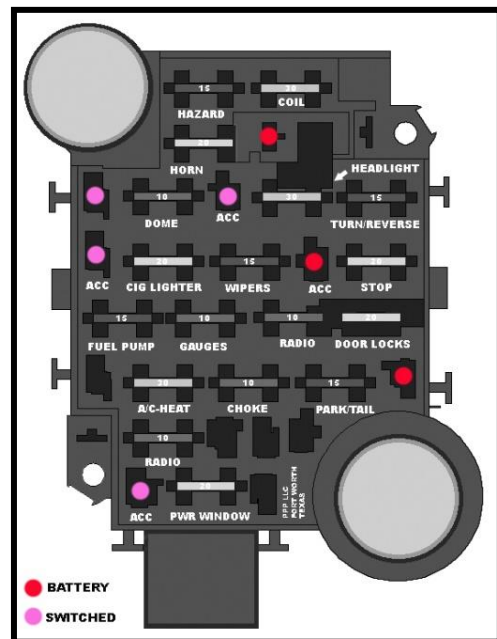

Relays and Switches

All ACCESSORY PORTS on the fuse block and the ports on the engine side of the bulkhead connector can support up to 15 amps. Components requiring more amperage will need to be connected to a relay. An ACCESSORY PORT can be used as a 12 volt activation source or 12 volt source for ground activation in these circumstances. *Take a look at [Painless part #'s 30107 & 30108](#) to fill your relay needs.*



A 12 volt activated relay is constantly grounded and will send power out of the output side of the relay to the component being powered when 12 volts is applied to the relay, as the name implies. The 12 volt source can be wired directly to the relay or interrupted by a switch, as shown in the 12 VOLT SOURCE ACTIVATION drawing; top drawing on the next page

Wiring directly to the relay, as indicated by the dashed line, would be used in the case of wiring a Fuel Pump relay, water pump relay, or any other high amperage component you would want to run continuously while the key is in the ON position. In these cases, make certain the 12 volt wire you are using is a Switched 12 volt wire and not a battery constant hot.

The 12 volt activation wire can also be wired to a switch to offer the user OFF/ON capabilities. These are the situations a battery constant power source would be used. This would allow a component to be turned OFF or ON without the key in the ON position. However, unless a lighted switch is being used, a ground activated relay may work better to avoid running power through the switch.

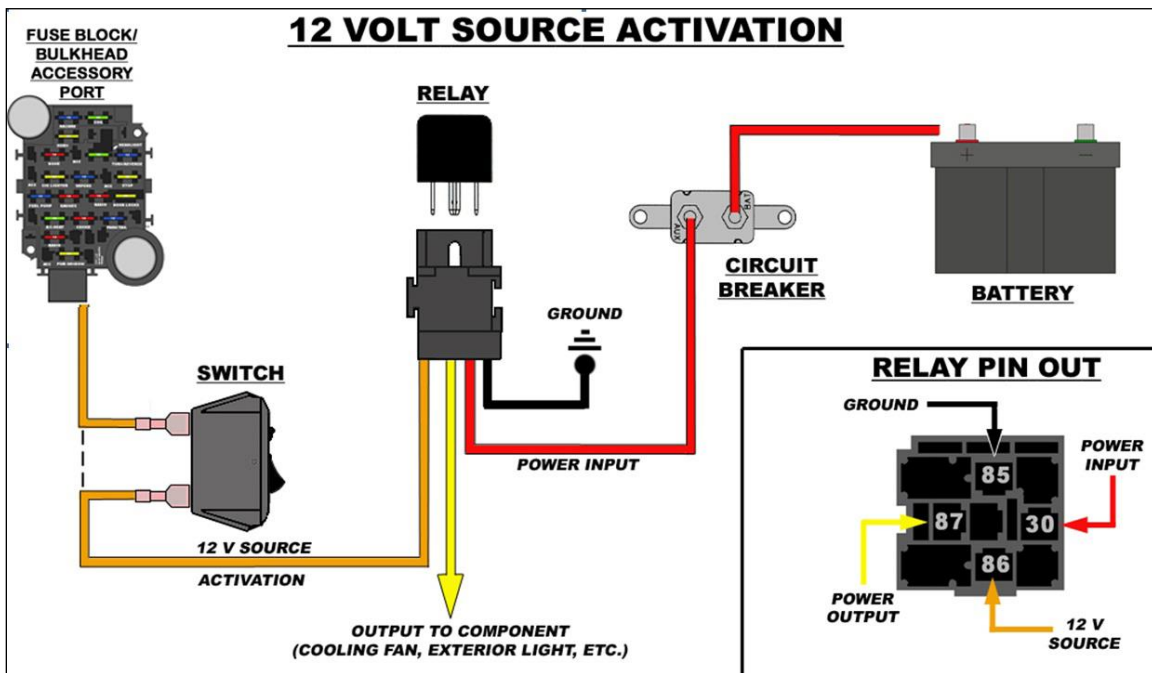

A ground activated relay is just the opposite of the 12 volt activated relay, 12 volts (battery constant or switched) is supplied uninterrupted and the ground wire is switched. The Horn Relay pre-wired in the Painless harness is a Ground Activated Relay. Another example of this method is a thermostat operated fan relay. In this case however, a thermostatic switch would replace the switch in the drawing below. Like mentioned before, ground activation method is best used when a component is operated by an unlit switch from the interior of the vehicle.

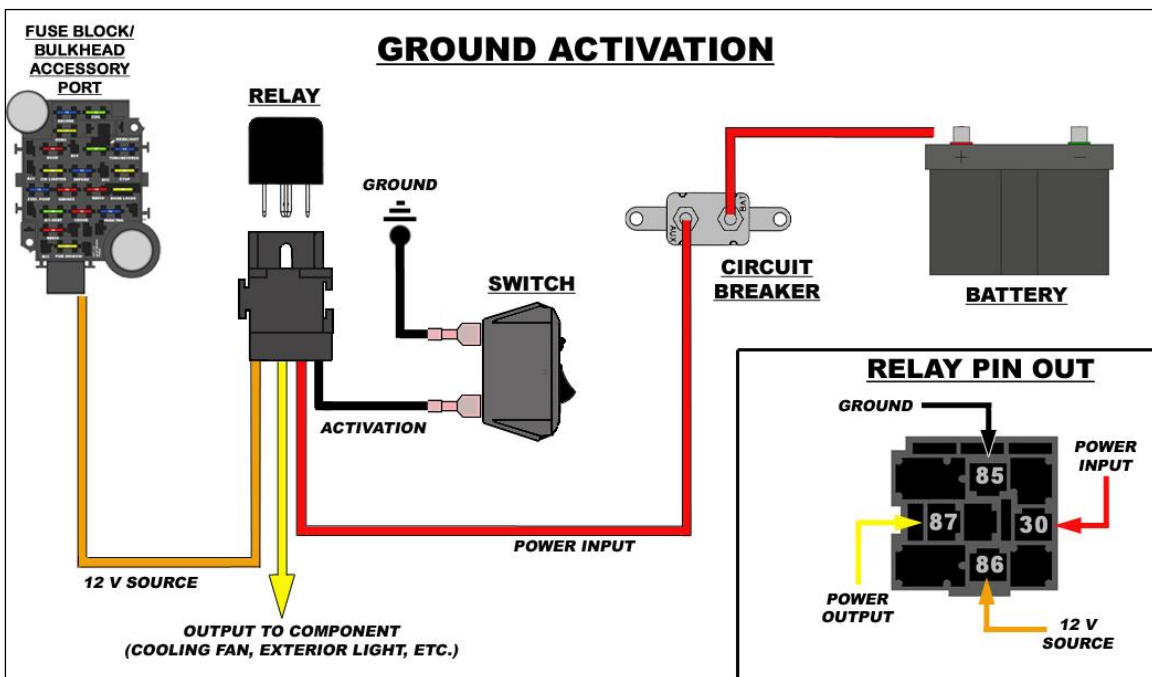

In the event that a toggle/rocker switch is being used without a relay, make sure the amperage of the component you are powering does not exceed the capabilities of the switch. Switch failure will occur.

FACTORY HARNESS REMOVAL

During the removal of the factory harness avoid making any unnecessary cuts to any wires. The entire harness should be able to come out of the vehicle without any cutting at all unless someone has modified connections. Labels have been provided to label each connection as it is removed. Individual wires which may have been add-on wires to aftermarket components which do not have a label on the sheet provided can easily be labeled using masking tape.

Labeling the factory harness is highly suggested as it may be helpful to look back at the factory harness during the install of the new Painless harness and will help you identify any things that are not included by the Painless harness that may need to be re-used.

Cars with factory air conditioning: During the removal process, the factory A/C harness does not need to be removed. It is its own separate harness. The power supply wire will simply need to be disconnected at the factory horn relay. This is a large gauge black wire, as seen in the photo, which will feed an inline fuse and then an orange wire. Remove this black wire and reroute it to the ac box on the firewall. This will be connected to a power source later in the manual, on [page 118](#).

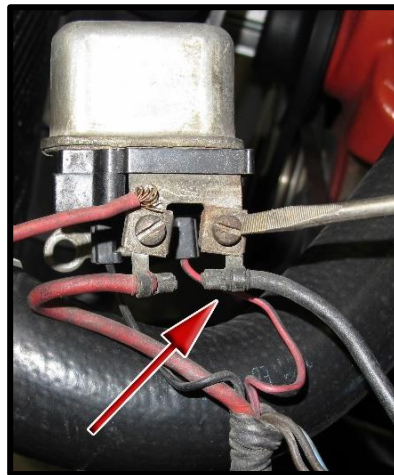

To aid in removal and installation of the harness, remove the driver seat or bench seat and the steering wheel. Steering wheel removal is not a necessary step, however, doing so will allow more movement to comfortably remove the factory harness and install the new Painless harness.



FUSE BLOCK MOUNTING

To begin mounting the fuse block, you will need to enlarge the 2 mounting bolt holes; these holes can be found next to the upper right and lower left of bulkhead opening. A 1/4" or 5/16" bit and an electric drill will be required for this modification.

- Using the drill bit, enlarge both firewall mounting holes. This will allow the 1/4" fuse block mounting bolts supplied with the Painless harness to pass through the firewall. This is easiest if done from the inside of the vehicle as shown below.



There is a bracket that hangs down above the fuse block that the original tail harness connector fit into. This bracket will not be used as this Painless uses a different connector than the factory tail harness connector. This bracket does not interfere with the fuse block but is very close. If the bracket has been bent downward it may contact the fuse block or the wiring exiting the top of the fuse block.

If during the next step, installing the fuse block, you experience this bracket interfering with the fuse block or the wiring of the new harness, you can do one of two things:



➤ Attempt to bend the bracket back up towards the windshield, this will give you the clearance you need to get the fuse block mounted.

or

➤ This bracket can also be removed as it is no longer needed.

With the holes now enlarged in the firewall, the fuse block can now be mounted.

- Remove the 2 nuts and flat washers pre-installed on the fuse block.
- Before being mounted, ensure you have the dimmer switch coming out of the bottom of the fuse block.
- Install the fuse block onto the firewall by inserting the bolts through the fuse block and then through the enlarged firewall mounting holes.

This next step will require a helper.

- On the engine side of the firewall, install the flat washers and nuts previously removed from the fuse block; this will require the use of a 7/16 socket as a wrench may be difficult to operate in the confined space. A helper with a flat head screw driver will be needed on the inside of the vehicle to keep the bolts from turning while the mounting nuts are tightened.

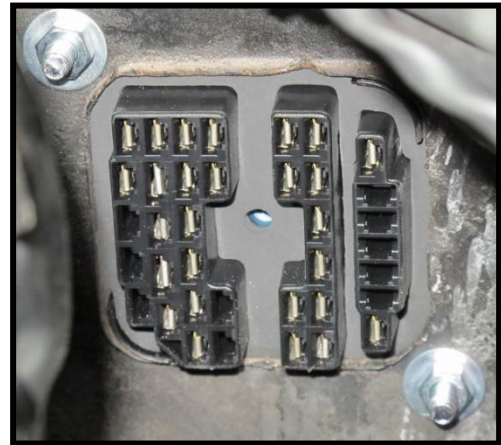
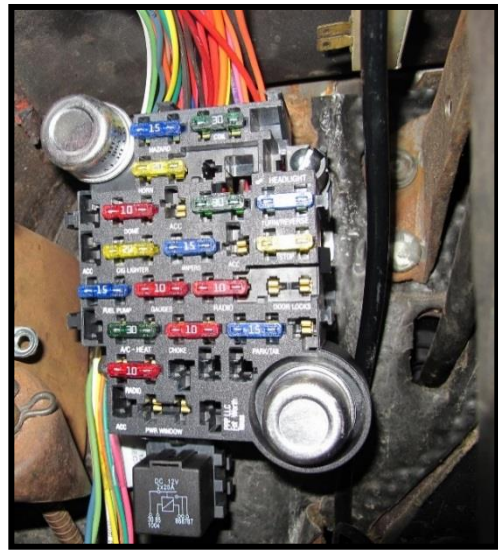

(Terminal position of your harness may vary from the one in the photo)

ENGINE HARNESS

The engine harness is broken down into 2 major groups of wires leaving the bulkhead connector:

- Light Section- contains wiring for the low brake switch, headlights, high beams, marker lights, park/turn signals, horn(s), and grounds.
- Engine Group - contains 6 sub-groups of wiring
 - Wiper Motor- contains wiring for the wiper motor
 - Alt- contains wires need for the charging system
 - Engine Section- contains wiring for oil pressure, temp sensor, electric choke
 - Ignition- contains wires for the coil or aftermarket ignition box (power and tach. signal)
 - Start- contains wires for the MIDI fuse, and starter connections
 - Blower Motor- a single power wire for the blower motor for heat only vehicles.

Engine Bulkhead

The photo to the right shows the interior bulkhead coming through the firewall in the engine compartment. The engine harness will plug directly into this connector. However before doing so, there is an optional feature built into this connector that can be beneficial to your install.

In the engine compartment, looking at the right hand side of the interior bulkhead, and highlighted/circled in the photo at right, you will see that there is a 7 pin portion with two pins having a terminal pre-installed. Both of these pins will have power anytime the key is in the "ON" / "RUN" position. This will make wiring up any under hood accessories requiring a switched power source easier than having to source power from the inside of the vehicle.

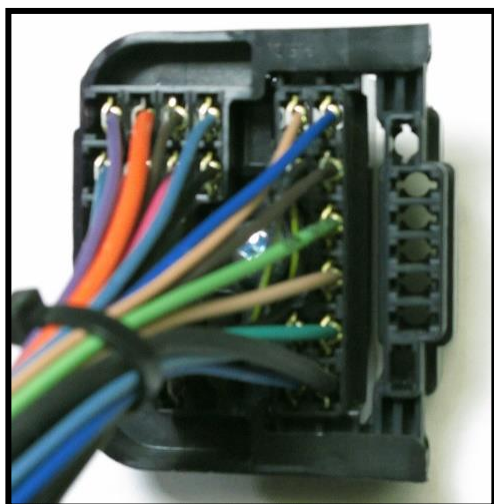
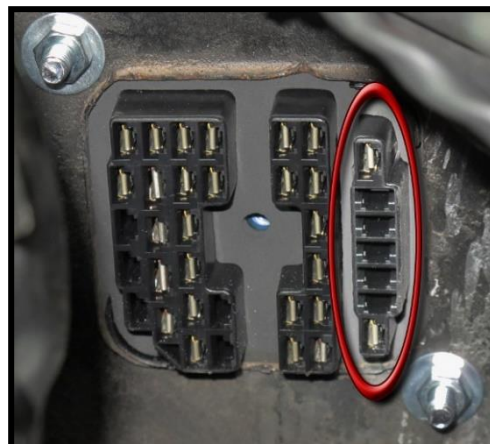

The power on these pins comes directly from the Ignition Switch. These pins are all unfused power sources and must have an inline fuse (not supplied) no larger than 15 amps, installed before being routed to a component needing power. Anything needing more than 15 amps will need to have a relay installed. See relay wiring and activation on [pages 17-18](#) for details.

Looking at the mating connector to the bulkhead on the engine harness, as seen to the left, you will notice that the wires needed for the accessory switched power pins are not included. This is so there would not be un-fused wires running out in the engine compartment. There is no harm in leaving these ports open if you do not require any addition switched power sources.

In order to utilize these switched power sources, you must add wires to the engine harness bulkhead. Terminals have been provided in the parts kit for these connections, seen in the photo to the right. These terminals will accept 18-14 gauge wire, using a ¼" strip length, and will need to be installed with jaw style crimpers as shown on [page 11](#).

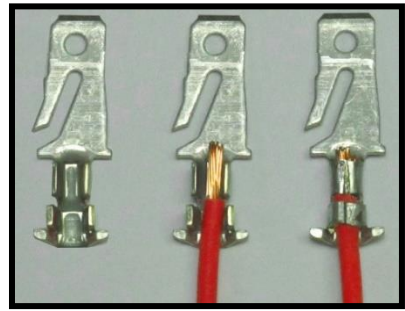

If any wires were added to the bulkhead connector for the extra switched power sources, group each wire with one of the sections of wires coming from the bulkhead according to where the fuse will be installed. For instance, if you are mounting an inline fuse on the driver side inner fender to power an accessory, the wire that would connect to this fuse will route with the **Light Section**.

Bulkhead Pin Out

Before connection of the bulkhead takes place, look over the pin out to see if there are any wires you will not be using. Things like electric choke, blower motor, gauge wires if you are using aftermarket mechanical gauges, and tachometer wire are all things some people may not be using. These unused wires can be removed to clean up the install and to keep unused wires from being taped or wrapped up in the harness. **Read through this entire manual before any wires are removed**, some wires can be repurposed and used for other things. Ideas and instances for other uses of these wires will be found in the section of manual conventional connections are explained. **UNDER NO CIRCUMSTANCES SHOULD YOU REMOVE ANY OTHER WIRES.**

Removal of these wires is simple and will require the use of a pair of pliers or a flat head screw driver.

- Squeeze the smaller side of the terminal in towards the center of the terminal. This will allow the terminal to be pulled free of the bulkhead.

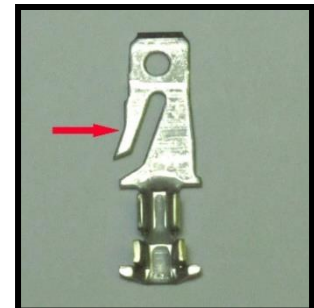

Be careful not to damage any of the surrounding terminals.

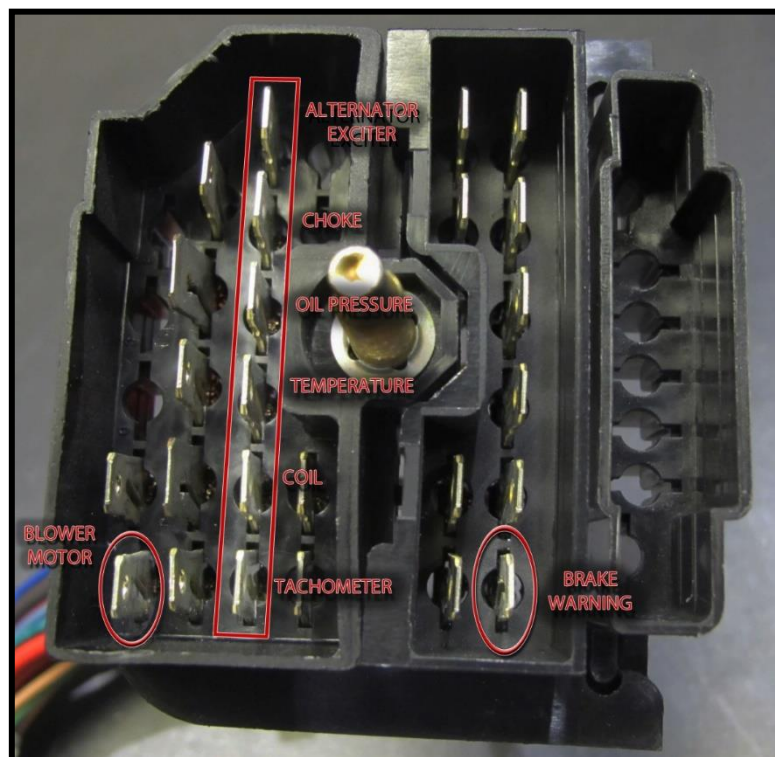

Engine Bulkhead Mounting

With all extra wires added to the engine bulkhead connector, if they were needed, it can now be installed onto the firewall connector.

- Push the engine bulkhead onto the firewall connector as far as you can, it will not go all the way on because of the bolt. Make sure the connector is on straight. The terminals of the bulkhead will easily bend
- Using a $\frac{3}{8}$ " socket, tighten the mounting thru bolt on the engine bulkhead to the fire wall connector. **DO NOT FORCE OR OVER TIGHTEN!**

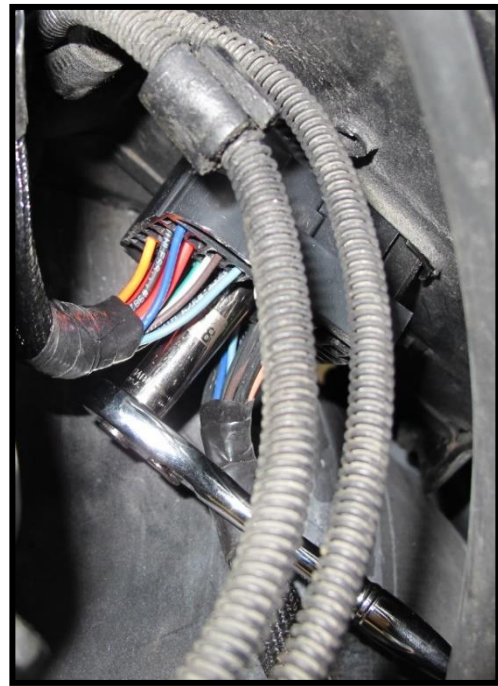

Engine/Light Harness Routing and Installation

The routing of the Engine/Light Harness will follow much of the factory harness routing. It will be up to you, the installer, to position all wires away from sharp edges, hood hinges, moving parts and exhaust heat.

“Umbrella” style clips for zip ties have been provided for you to attach the Painless harness to the inner fender and the core support in the same fashion the factory did. These zip tie clips fit into the $\frac{1}{4}$ " holes left behind by the factory plastic retainer loops.

Remember, as the zip ties are installed and the harness is routed, wrap the tie around the harness and **LOOSELY** tie the harness to the fender/core support. Make sure you leave enough room to pull and push the harness as you make your connections. Only when all connections are made, will the zip ties be tightly snugged down.

If you still have an externally regulated alternator, and the regulator is mounted on the driver side core support, re-routing of the “Alternator Section” and additional wiring (*not included*) will need to be added to the “Lighting Section” of the engine harness. See [page 50](#) for details on these wires before routing any of the Light Section.



Light Section

The Light Section has a little extra length added to allow the installer to route the harness over the inner wheel well, behind the driver side fender, as shown below. Doing so will make for a cleaner install as there will not be wires routed down the fender out in the open as the factory did.

- Route the Light Section towards the front of the vehicle. If this section is routed behind the driver side fender, make sure the “Low Brake Switch” wire remains on the engine compartment side.

If the harness is routed out in the open as the factory harness was, use the umbrella zip tie clips, installed into the holes left behind by the factory plastic clips, to loosely secure the new Painless harness.

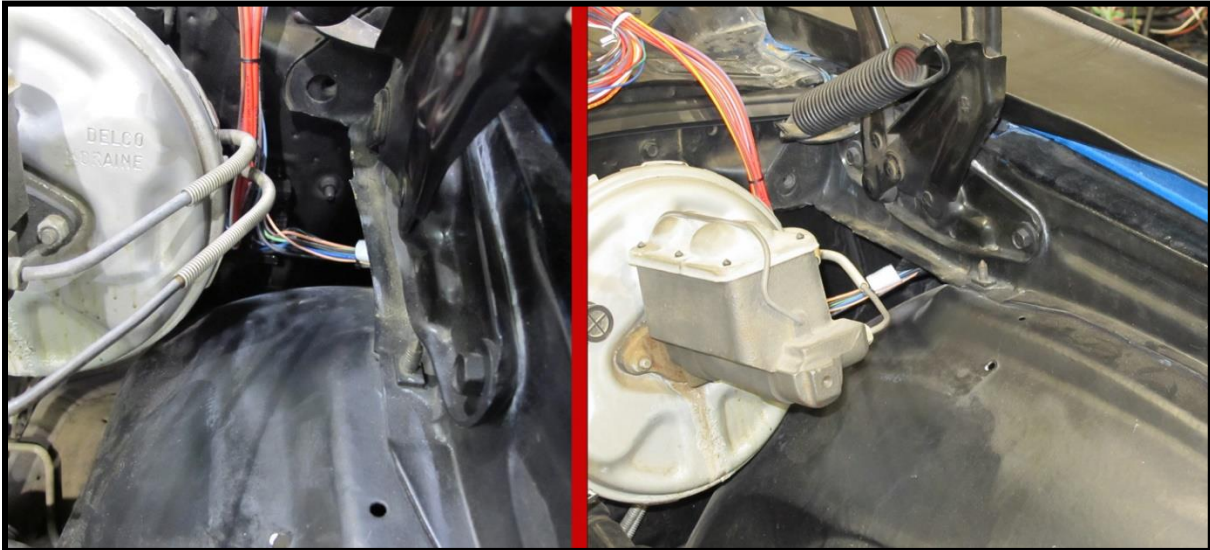

“Brake Warn Switch”

The Brake Warn Switch is a normally open switch that will close and send a ground signal to the brake indicator light on the dash. This is done when the bias valve inside the pressure valve has shifted forward or back because of line pressure differences. This is usually caused by broken/leaking brake line, faulty caliper or wheel cylinder. Notice, this is a pressure switch not a fluid level switch.

This switch is only necessary if you want the brake warning light in the dash to indicate low brake fluid pressure. If you have aftermarket gauges without a brake warning light, then this connection can be skipped and this wire can either be stowed into the Light section of the harness or removed from the bulkhead, as described on [page 23](#).

The factory valve, as seen in the left photo on the next page, is located on the driver side frame, about where the floor pan and firewall meet; follow the brake lines from the master cylinder. Those who have upgraded their braking system or have switched to a newer style master cylinder, may find this valve on the underside of the master cylinder itself, as seen in the right picture on the next page. If you have an aftermarket proportioning valve, you may not have one of these switches. Aftermarket valves that have a two pin switch on them are normally for brake light activation, this type of switch will not work as an activation source for the indicator light on the dash.

The Brake Warn Switch is a one wire connection. This will be a wire with a label reading “LOW BRAKE SWITCH”. This wire is:

Tan: 18 gauge wire, printed with **#968 BRAKE WARN SWITCH**, supplies a ground signal to the low brake light on the dash. This wire goes into the bulkhead connector and is spliced together with the wire going to the emergency brake switch on the interior of the vehicle; see the [Gauge Cluster Schematic](#) on [page 97](#).

- Connection to the Low brake switch can be done two different ways.
 - You can use an insulated bullet or socket terminal found in the parts kit. Some switches require a male terminal, while others require a socket terminal.
 - You can cut the molded connector from your factory harness and splice it to the wire of the Painless kit.

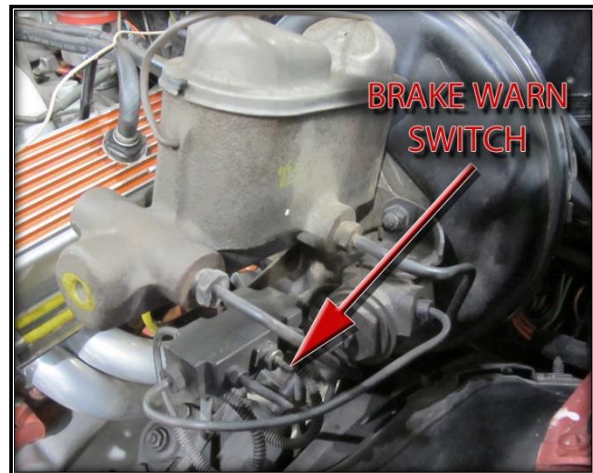
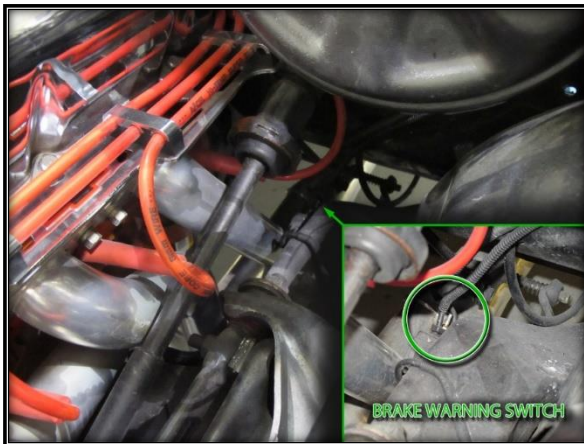

“Left Side Marker”

The driver side fender mounted marker light is the first connection to the front exterior lights. It serves two purposes: it is a park light as well as a turn signal. The park light feature is activated by a power source coming from the headlight switch. This light will illuminate any time the headlight switch is in the *PARK* or *ON* position. The turn signal feature is provided by a power source coming from the turn signal switch. This light does not need a ground, it uses the front turn/park signal filaments for ground.

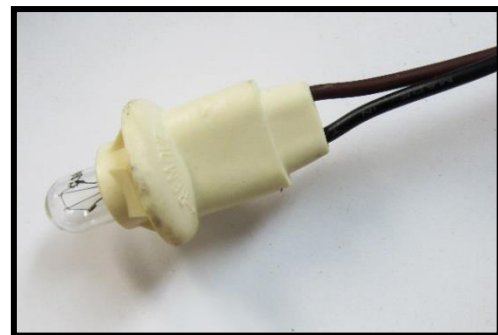

The Left Side Marker requires two wires to work properly, seen in the [Front Lighting Schematic](#) on [page 32](#). A factory style socket comes pre-installed and will have a label reading “MARKER”. The wires spliced to this molded connector are:

Brown: 18 gauge wire, not printed, this is a power wire for the park or marker light function. This wire is spliced to the other **#927** wires in the Light Section. This wire will have power anytime the headlight switch is in the Park/Tail Lights ON or Headlights ON position.

Black: 18 gauge wire, not printed, this wire is the power for the turn signal function. This wire goes into a splice with the light blue wire going to the front left turn/park light and to a wire coming from the bulkhead. This wire will have interrupted switched power from the turn flasher any time the left turn signal is activated and interrupted battery power from the hazard flasher any time the hazard switch is in the ON position.

- Install one of the provided wedge base bulbs into the socket. Adding a small amount of dielectric grease to the contacts beforehand will help prevent any corrosion issues.
- Looking at the back of the marker lamp housing you will see that it has a keyed opening to correspond with the tabs on the socket (as seen in the photo).



- Insert the lamp socket of the Painless harness into the “Left Side Marker” housing and turn $\frac{1}{4}$ turn clockwise to lock the socket in place.

“Left Headlight”

Your next connection in the **Light Section** will be the Left Headlight. Three wires make up the connection. These wires go into a black three pin connector. This group of wires will have a section label reading “HEADLIGHT”, these wires are:

Light Green: 14 gauge wire, printed **#908 HIGH BEAM POWER**, this wire will provide power to the high beam filament of the head lamp. This wire goes into a splice with a wires going to both inner high beam lamps and the right headlamp and also to a wire going to the bulkhead and can be seen in the [Front Lighting Schematic](#) on [page 32](#) . This wire will have power when the headlight switch is in the headlight ON position and the dimmer switch is in the high beam position.

Tan: 14 gauge wire, printed **# 909 LOW BEAM POWER**, this wire will provide power to the low beam filament of the head lamp. This wire comes from the bulkhead connector and can be seen in the [Front Lighting Schematic](#) on [page 32](#). This wire will have power when the headlight switch is in the headlight ON position and the dimmer switch is in the low beam position. Another tan wire can be found in this connector; it feeds power to the passenger side headlamp.

Black: 14 gauge wire, printed **#969 HEADLIGHT GROUND**, this wire provides a ground source for the headlamp. This wire is tied into the integrated ground circuit and can be seen in the [Ground Schematic](#) on [page 15](#).

- Add small amount of dielectric grease to the terminals before plugging the connector into the headlamp. Doing so will help prevent any corrosion issues.



- Holes in the core support will allow access to the headlight terminals, so removal of the bulb is not necessary. Plug the connector on the Painless harness into the back of the headlamp. Use caution while installing, ensure the connector is installed straight onto the terminals of the headlights; they can easily bend and break.



If halogen bulbs are being used Painless recommends using Painless part # 30814, seen below. This additional relay harness is needed to avoid overloading the headlight switch with the higher demands of halogen bulbs and also provide the halogen bulbs a direct power source from the battery. The 30814 headlight relay kit will do both headlights and high beams and will plug directly into the new chassis harness.

“Left High Beam”

The Left High beam will follow the connection of the headlight. This connector is the same as the headlight connector, however, only two wires make up the connection. This group of wires will have a section label reading “HIGH BEAM”, these wires are:

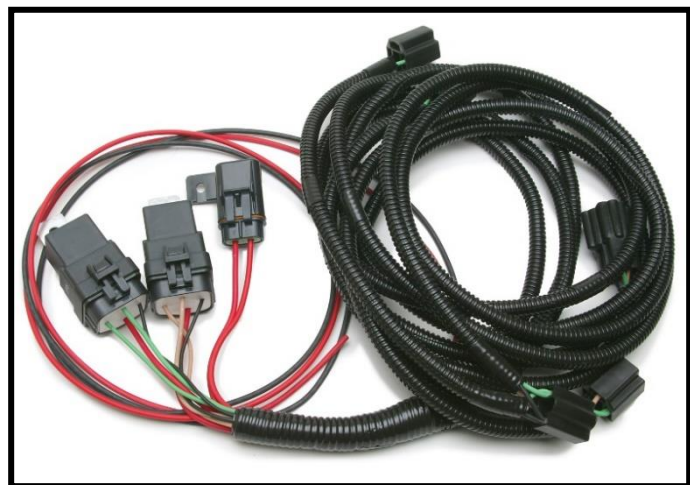

Light Green: 14 gauge wire, printed #908 HIGH BEAM POWER, this wire will provide power to the high beam filament of the head lamp.

This wire goes into a splice with wires going to the both inner high beam lamps and the right headlamp and also to a wire going to the bulkhead and can be seen in the [Front Lighting Schematic](#) on page 32. This wire will have power when the headlight switch is in the headlight ON position the dimmer switch is in the high beam position.

Black: 14 gauge wire, printed #969 HIGH BEAM GROUND, this wire provides a ground source for the headlamp. This wire is tied into the integrated ground circuit and can be seen in the [Ground Schematic](#) on page 15.

- Add small amount of dielectric grease to the terminals before plugging the connector into the headlamp. Doing so will help with prevent corrosion.
- Holes in the core support will allow access to the high beam terminals, so removal of the bulb is not necessary. Plug the connector on the Painless harness into the back of the headlamp. Use caution while installing, ensure the connector is installed straight onto the terminals of the headlights; they can easily bend and break

“Left Turn/Park Light”

The last connection needing to be made before routing the Light Section across the core support is the “Left Turn/Park Light”. This light has a dual filament bulb that works as a turn signal and as well as a park light. The turn signal will be the brighter of the two filaments.

New bulbs for the front Turn/Park Light have been supplied. The bulb this lamp requires has universal part number 1157, replacement bulbs can be found at any auto parts store under this part number. Again, this will be bulbs with 2 filaments and 2 contacts on the bottom of the bulb.



The Left Turn/Park Light of the Painless harness consists of two wires in a two pin connector will be identified by a label reading “L TURN”. These wires can be seen in the Front Lighting Schematic on [page 32](#), they are:

Brown: 18 gauge wire, not printed, is the power source for the park light. This #927 is spliced to the other #927 wires in the Light Section. This wire will have power anytime the headlight switch is in the Park/Tail Lights ON or Headlights On position.

Light Blue: 18 gauge wire, not printed, this wire is the turn signal power and part of the #926 circuit. This wire goes into a splice with the light blue wire going to the front left marker light and to a wire coming from the bulkhead. This wire will have interrupted switched power from the turn flasher any time the left turn signal is activated and interrupted battery power from the hazard flasher any time the hazard switch is in the ON position.

- To ensure the turn signal and park lights work properly, if you are reusing an original/old housing, it is a good idea to remove the light housing from the bumper and clean the areas where the housing mounts to the bumper and then reinstall. These points are where this housing grounds through. Cleaning these grounds now can save hours of troubleshooting later.
- Begin by adding a very small amount of dielectric grease to the terminal end of the connector on the pigtail coming from the turn signal, as seen in the photo.
- Plug the 2-pin connector found on the Painless harness into the connector coming from the turn signal housing.
- Install a bulb into the turn signal socket, this is done by removing the two screws that hold the lens in place. Place a small amount of dielectric grease on the bulb to help with corrosion that can make removing the bulb at a later date difficult.



Passenger Side Light Section Routing

The remainder of the **Light Section** now needs to be routed across the core support. In order to do this properly, the Radiator hold down must be removed.

- Removal will require a $\frac{1}{2}$ " socket or wrench to remove the 4 bolts. Take notice of the rubber isolator at each end of the hold down, these could fall off during hold down removal. If so, then they simply need to be put back in place before the hold down is reinstalled.

With the hold down removed you will now have access to the channel that runs on the underneath side of the top part of the core support. This is a great place to make use of the umbrella zip tie clips included with kit as this channel has $\frac{1}{4}$ " holes along the top at each end, circled in the photo below.



- It is easiest to first install the zip tie into the clip, as shown, and then push the clip into the hole. Once the clip is in place, the zip tie can then be tied around the harness. Remember to loosely install the zip ties. The zip ties should not be tightened until all wires of the **Light Section** are connected.

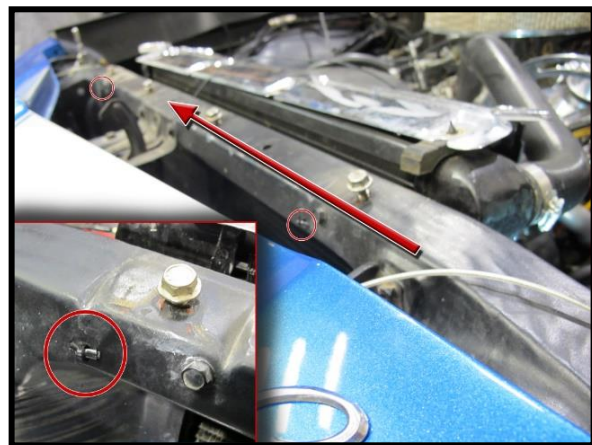

- Route the wires going to the passenger side across the core support.

"Horn(s)"

Some vehicles have 1 horn, while others have 2. The Painless harness has a single open ended wire that must be cut to length and terminated but can accommodate single or dual horn cars by following the instructions below. This single open ended wire in the **Light Section** can be seen in the [Turn Signal Switch Schematic](#) on page 65, it will have a label reading "HORN." It is:

Black/Green: 14 gauge wire, printed **#924 HORN POWER**, this power wire comes from the fuse block mounted horn relay which is ground activated by the horn button on the steering column. This wire will only have power when the horn button is pressed.

- Locate the power connection tab on the horn, this will simply be a tab coming out of the side. Horns ground through their mounting so they only require a power connection. A good clean surface where the horn mounts to the hood latch support will help with the ground connection.
- Route the wire to the power connection point on the horn, or one of the horns if you have 2. Before the wire is cut to length make sure there is enough length to secure the wire to the latch support if so desired.

- Cut the wire to length and strip $\frac{1}{4}$ " of insulation from the wire. If you have a second horn, strip $\frac{1}{4}$ " of insulation from the cut off piece of wire.
- In the parts kit, locate the connector and a terminal seen in the photo for each horn.
- Using the rollover crimpers provided with this kit, crimp the terminal onto the **#924** wire.

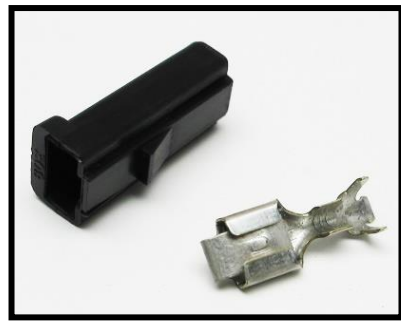

If you have two horns, the cut off piece of wire that was stripped will double up with the **#924** coming from the harness, giving you 2 wires in one terminal, like seen at the top in the photo to the right. This is known as "Chaining", "Linking", or "Jumping"; like shown in the schematics on [pages 77-79](#).



- Install a connector on to this terminal and plug it into the horn. If you have a second horn, route the wire from this first horn over to the second horn, cut to length, strip, terminate, and connect.

"Right Turn/Park Light", "Right Headlight", & "Right Marker Light"

The 3 connections mentioned above all connect in the same manner as those on the left side. The only difference you will find is the Turn signal wire for the right turn signal is a different color than that one used for the left turn signal. The right Turn signal will be an un-printed 18 gauge Blue wire.

"Ground"

The ground on the right side, or passenger side, of the vehicle is intended to connect directly to the negative side of the battery. This will tie all of the grounds found in the Painless harness directly back to the battery, as explained in the [Grounds](#) portion of this manual on [page 13](#).

- Connect the 10 gauge Black wire, printed **#969 BATTERY "-"/ GROUND SOURCE** to the negative side of the battery.
 - If you are using a side post battery, see below.
- If the battery has been relocated to the trunk, or a side post battery is being used. Connect this wire to the core support where the factory ground wire for the passenger side headlight was connected, next to the headlamp access hole. Makes sure the ground area is clean of dirt, rust and/or paint. Small star washers have been provided to help with this connection.



- Source a heat shrinkable ring terminal from the parts kit to accommodate the bolt of the negative battery lug or screw used on the firewall.

This concludes all of the connections in the **Light Section** of the engine harness. Go back inspect the harness layout and once satisfied it is free of moving parts and sharp edges tighten any loose zip ties.

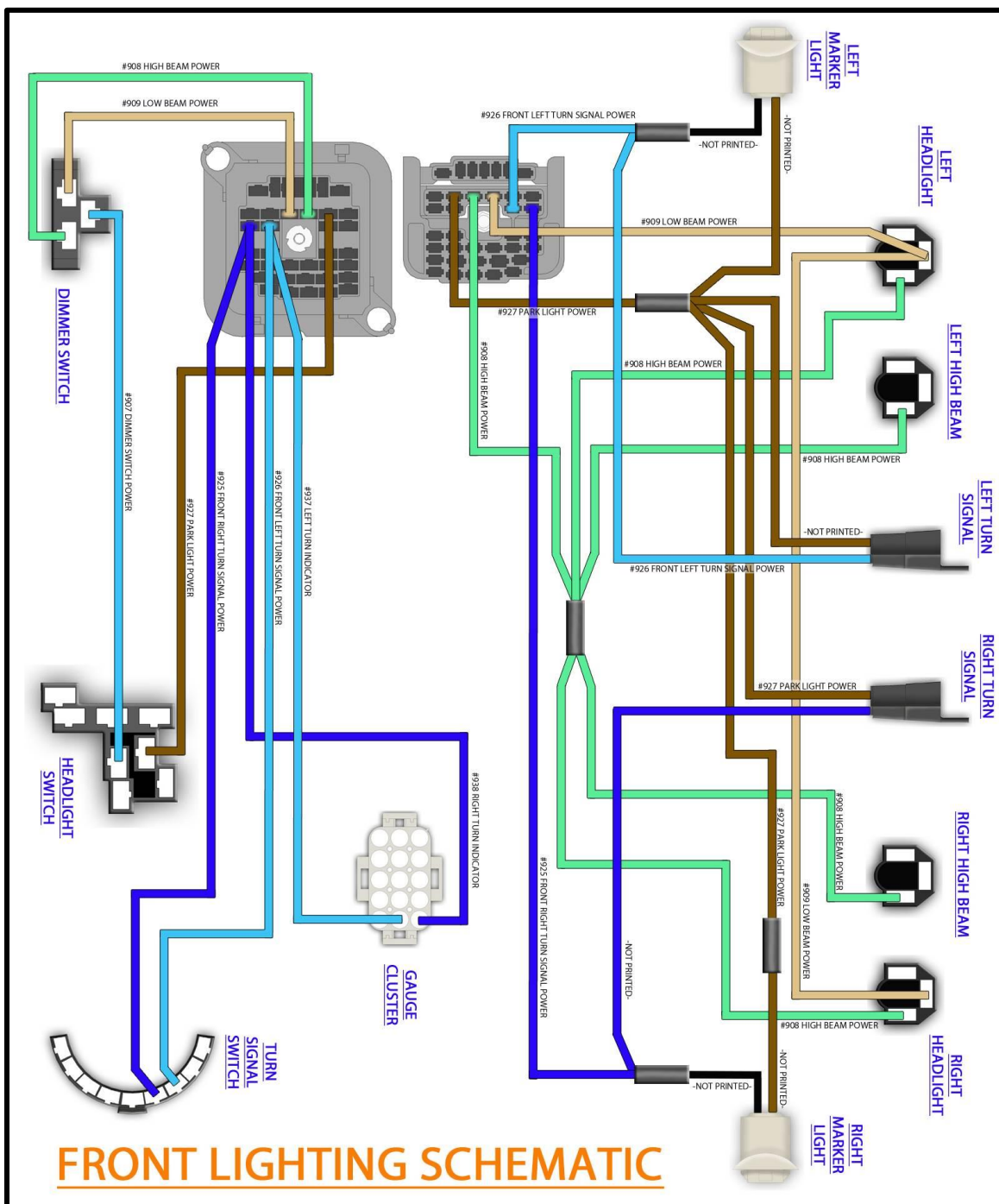

This schematic shows power wires only, grounds for the headlights & high beams can be seen in the [Ground Schematic](#) on page 15.

Engine Harness Routing

With the exception of the Wiper Motor & Washer Pump connections, this section of the harness is universal in nature as it is intended to fit multiple, engine, ignition, and charging system applications. Being universal, means all wires will be open ended and will need to be routed, cut to length, and then have the appropriate terminal installed.



Routing of this section will take the harness across the firewall, towards the passenger side of the vehicle.

- The factory harness sat in a harness hook located above the master cylinder, seen in the picture above right.

If the hook is no longer in place, an Adel clamp has been included. This is provided since drilling a hole for a zip tie mount may not be an option because of the brake booster. Using this clamp will require re-using the factory harness hook bolt.



- Once the harness is secure in this location, route the harness over the booster, and behind the wiper motor, as seen below



- At this point, the remainder of the Engine Harness will be routed as individual connections are made.

“Wiper Motor”

The Wiper Motor is mounted on the firewall. It receives ground signals from the wiper switch in order to operate. The power feeding the wiper motor comes from the 15 amp WIPER fuse and will have power anytime the key is turned in the “ON/RUN” position. The wires that make up the “Wiper Motor” connection can be seen in the [Wiper Switch Schematic](#) on page 94.

Locate the group of wires in the Painless harness labeled “Wiper Motor”. This will be two connectors, a 2 pin connector and 1 single pin connector; these wires are:

2-Pin Connector

Black: 16 gauge wire, printed **#979 WIPER MOTOR (LOW/PARK)**, this is a ground signal from the wiper switch.

(2) Black/Yellow: 16 gauge wire, printed **#982 WIPER MOTOR POWER**, this wire will supply switched ignition power to the wiper motor from the 15 amp WIPERS fuse on the fuse block. The unprinted black/yellow doubled up with wire provides power to the washer pump.

Single Pin Connector *(can be a black or red connector depending on the connectors on hand when assembled)*

Light Blue: 16 gauge wire, printed **#977 WIPER MOTOR (HIGH)**, this is a ground signal from the wiper switch.

- On the bottom side of the motor you will see 3 tabs sticking out; these are the connection points for the Wiper Motor.

Connect the 2-pin connector to the tabs closest to the engine. The black wire should be on the bottom tab, the (2) **Black/Yellow** on the middle tab, as seen below.

Connect the single pin connector with the **light blue** wire to the top tab.

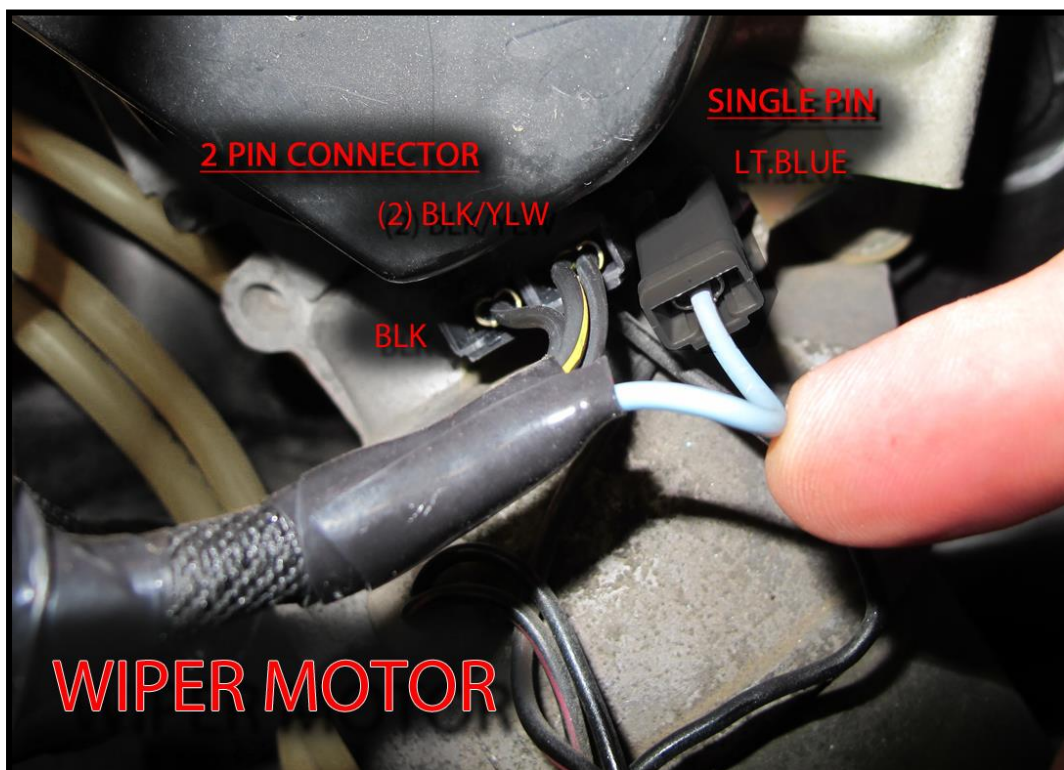

“Washer Pump”

The Washer Pump receives a ground signal from the wiper switch to activate the pump. Once activated, it will pump washer fluid from the reservoir to the washer nozzles at the base of the wiper cowl below the windshield.

Two wires are required for proper connection to the Washer Pump. This will be a 2-pin brown/tan connector on the Painless harness with a label reading “WASHER PUMP”. The wires in this connector are:

Blue: 16 gauge wire printed with **#984 WASHER PUMP GROUND**, this wire will provide the Washer Pump with a ground source from the wiper switch when the switch is in the *Wash* position.

Black/Yellow: 16 gauge wire, printed **#983 WASHER PUMP POWER**, this wire supplies power to the Washer Pump from the 20 amp Wiper fuse on the fuse block. This wire will have power anytime the key is in the *ON/RUN* or *ACC* positions.

These wires can be seen in the [Wiper Switch Schematic](#) on [page 94](#).

- Connect these wires to the 2 tabs on the “Washer Pump”. These tabs will be in the center of the black cover of the wiper motor.

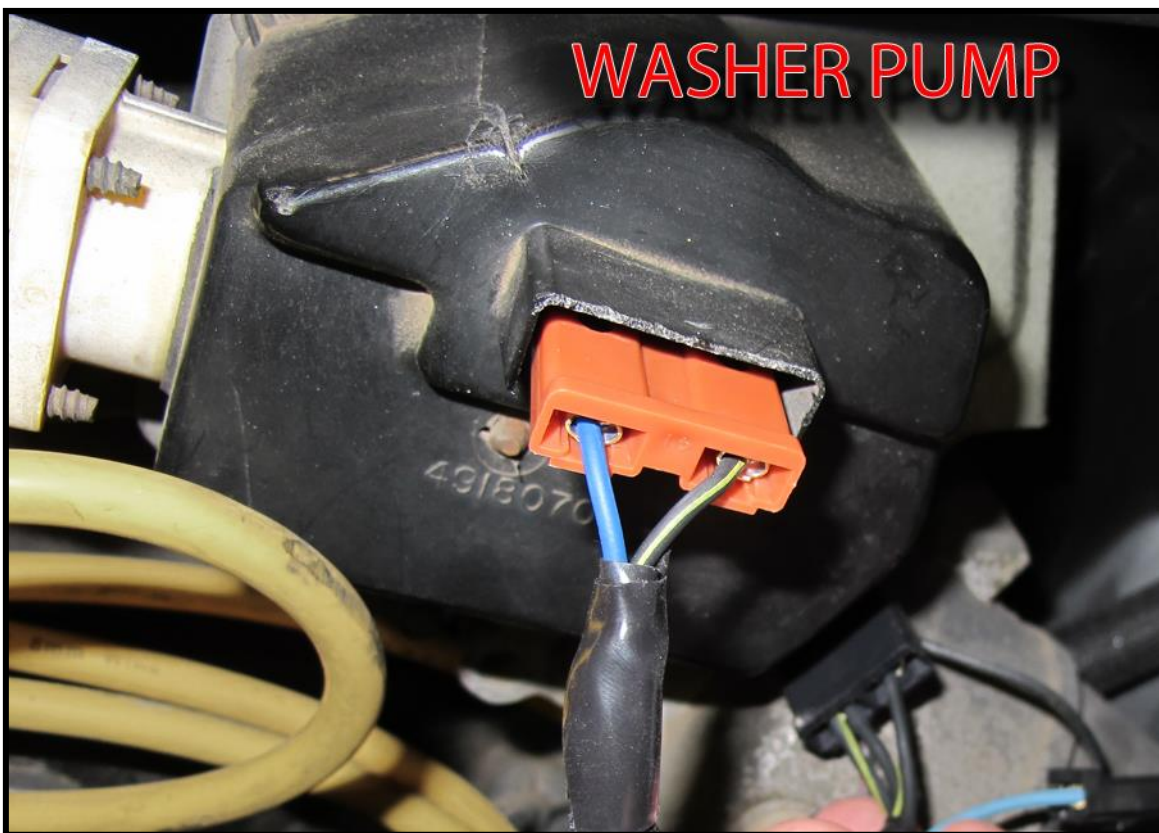

Engine Section

The Engine Section consists of three wires for connections to oil pressure and coolant temperature sending units for the gauges, and a connection for an electric choke on a carburetor. Locations of all of these components will vary from vehicle to vehicle so no specific routing instructions can be given.

All wires of the Engine Section are open ended wires, meaning they do not have terminals or connectors pre-installed. This is because all wires have ample length to account for the numerous way components can be mounted on the engine.

Engine Sending Units/Switches

If you are using aftermarket mechanical gauges, then no connections will need to be made. You can skip to the next connection, “Electric Choke” on the next page.

Sending units work based on resistance to ground. Meaning the cooler the engine or less oil pressure seen, the more ground (less resistance) these sending units will provide to the wire connected to them. As the ground resistance strengthens as the temps and/or pressure builds, less ground is applied to the gauge. As the ground signal weakens, the needle on the gauge moves to read higher temps and/or higher oil pressure. If you were to not connect these at all, the gauges would peg to their highest reading.

A simple troubleshooting procedure, after the harness has been installed and if you have gauge issues, is to disconnect the wire at the sending unit going to the gauge. Leave it disconnected and then ground this wire. If the needle on the gauge moves, when disconnected and grounded, the gauge is in working order, has good power and ground, and you may have sending unit issues.

Cars equipped with a factory indicator light dash have switches instead of sending units, although they look alike. These switches simply send a ground signal to the light to turn it on when the temperature is high or oil pressure low enough to cause the switch to close. Grounding these wires will make the light come on.

“Coolant Temp”

Locate the 18 gauge **Green** wire printed **#921 COOLANT TEMPERATURE SIGNAL**. This wire will send a ground signal through the bulkhead into the interior of the vehicle to the gauge cluster and aftermarket gauge connector. If you are using an aftermarket mechanical gauge, this wire will not be used. This wire will work with aftermarket electrical gauges and senders.

The coolant temp sending unit/switch can be mounted in the intake manifold or in the side of either cylinder head. These will have a peg, tab or threaded post to connect to. Two wire temperature sensors on fuel injected engines that have weatherproof connectors are for engine computer input, not for gauge signal. Also, if connecting to an engine in a vehicle that has electric fans, make certain you know the difference between the coolant temp sensor and the electric fan thermostatic switch. Both of these sensors can look identical.



If you are installing a new temp sensor, if sealant is needed, **use a paste type sealant and not Teflon tape** on the sensor threads. The tape will interfere with the ground source the sensor needs to read correctly.

- Route this **Green #921** wire to the coolant temp sensor, cut to length, install the appropriate terminal for your connection, and connect.

Terminals and a factory style connector, seen in the photo to the right, have been supplied to allow connecting to a factory style sensor; like shown on the previous page. Rollover crimpers will be needed to properly install this terminal.



“Oil Pressure”

Locate the 18 gauge **Blue** wire printed **#922 OIL PRESSURE SIGNAL**

The **#922** wire will send a ground signal from the sending unit/switch through the bulkhead into the interior of the vehicle to the gauge cluster and to the aftermarket gauge connector.

The oil pressure sending unit will generally be located near the oil filter. On later model fuel injected engines this pressure sensor will generally be found at the back the engine behind the intake manifold.



- Route this **Blue #922** wire to the oil pressure sending unit, install the appropriate terminal for your connection, and connect.

Terminals and a factory style connector, seen in the photo above, have been supplied to allow connecting to a factory “stud” style sensor.

“Electric Choke”

Locate the 18 gauge red wire printed **#954 CHOKE POWER**. This wire will provide a switched ignition power source to the choke from the 10 amp CHOKE fuse. This wire will have power when the ignition switch is in the ON/RUN position.

When you turn your key to the “ON/RUN” position, the voltage this wire carries will heat the bi-metal spring attached to the shaft of the choke. This spring will unravel as it is heated causing the choke to slowly open. When the ignition is turned to the “OFF” position, power is no longer on this wire, causing the spring to begin to cool and contract, closing the choke.

If you do not have an electric choke, or even a carburetor, this wire will not be needed and can be removed from the harness. It can also be used to power an aftermarket accessory that requires a switched 12v source or a factory component not supported by the Painless harness, like the Turbo 400 TCS relay.



- Route this red **#954** wire to the + terminal of the electric choke, install the appropriate terminal and connector for your connection, and connect.

Ensure the choke is properly grounded, ground wire not supplied in the Painless harness, before continuing with the installation.

Coil/Ignition

The wires marked **Ignition Section** are for Coil/Ignition connections. Usage of only one or both wires will depend on the components used in your particular installation. These two wires will be exceptional long compared to the other wires of the engine harness. This is to account for those who may have an ignition box mounted inside the vehicle or on the passenger side of the vehicle.

“Coil Power”

Locate the 16 gauge White/Orange wire, it will be printed with **#920 COIL POWER (“+”)**. This wire comes through the bulkhead from the 20 amp COIL fuse. An added bonus of the coil fuse is it also provides a built in theft deterrent. Removing the COIL fuse from the fuse block when the car is parked for periods of time will not allow the ignition system to function, making the vehicle impossible to start/run. This wire will provide the Coil or ignition system with switched power in one of four ways depending on your ignition system, one of the processes explained on the following four pages will walk you through this connection:

Points & Electronic Ignition w/ “Resistor Required” Coil

- If the Coil you are using is not internally resisted, a ballast resistor along with the Yellow wire mentioned in the next step, must be used. A coil will usually have some kind of print on it that states “RESISTOR REQUIRED” or “NO RESISTOR REQUIRED”. A ballast resistor, not included due to a lack of usage, resists the current going to the coil. **If a coil is not internally resisted and a ballast resistor is not used the coil will overheat within a few minutes to the point it will no longer work.** Your factory harness used a resistance wire to accomplish this. If you need a ballast resistor, which has a universal part number RU-11 contact Painless, your favorite parts supplier, or your local auto parts store. See the [Ballast Resistor Connection Diagram](#) on the next page.
- Using a self-tapping screw from the parts kit, mount the ballast resistor to the firewall. The resistor gets very hot during operation so do not mount this to any kind of plastic.
- Route the **#920** to one side of the resistor, it does not matter which side. Cut to length and save the cut off piece of wire, strip ¼ of wire and install either a pink weather proof insulated terminal or a factory style terminal and connector.
- Plug this wire onto one side of the ballast resistor.

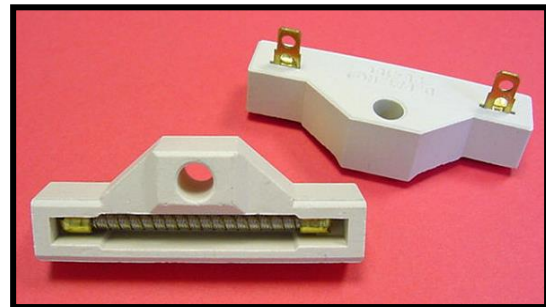

- The cut off piece of **#920** will now connect the other side of the resistor and to the positive (+) side of the coil. Before making any connections, a bypass wire from the parts kit will also need to be installed, as seen in the [Ballast Resistor Connection Diagram](#) on the next page.

“Ignition Bypass”

Locate the 16 gauge, **Yellow** wire printed **#970 IGNITION BYPASS (COIL "+" TO STARTER "I")**. Due to a lack of usage, this wire is not part of the harness but in the large bag supplied with this harness. At this time, only the connection to the coil or resistor is taking place, however, when this wire is connected to the starter, as indicated in a later step on [page 51](#), it supplies a full 12v power source when the ignition switch is in the START or “crank” position. The purpose of this wire is to provide the coil full 12v power when the starter solenoid is engaged by bypassing the ballast resistor and going directly to the coil. This is done to facilitate starting the engine and will not harm the coil.

This wire will only be needed if you are using a ballast resistor. Most installs will not need this wire.

- Connect the Yellow **#970** wire to the + side of the Coil or to the output side of the Ballast resistor. The [Ballast Resistor Connection Diagram](#), below, has been created to aid in this connection. If it is connected to the ballast resistor, double this **#970** with the **#920** into one terminal as shown in the schematic.
- Once connected to the ballast resistor or coil, this wire needs to be routed/grouped with the large gauge Red and Purple wires labeled **Starter** as the other end of this **Yellow #970** wire will connect to the starter.

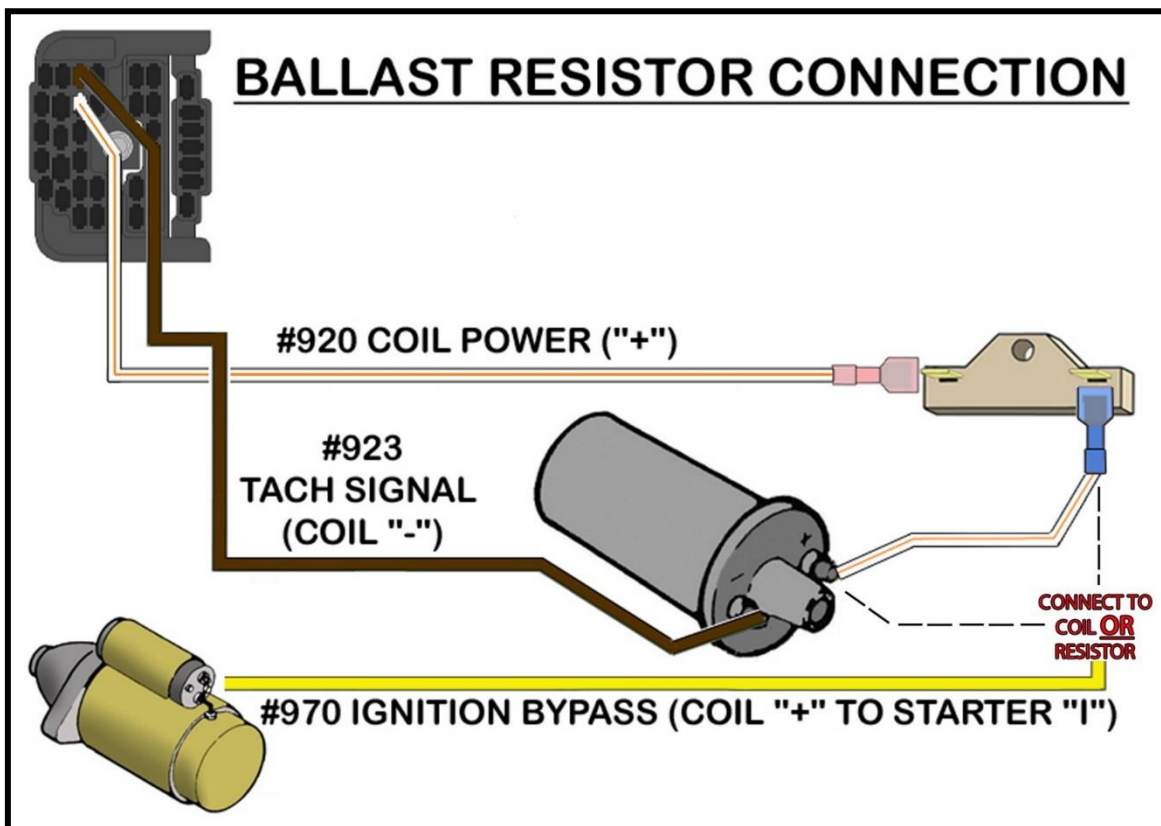

HEI & Resisted Coils

- HEI coils and internally resisted coils do not require the use of a ballast resistor. The **#920** wire will connect directly to the + side of the coil. See the "[NO Resistor Connection Diagram](#)" below.
- Route this white/orange **#920** wire to its proper connection point and cut to length, install the appropriate terminal for your connection, and connect.

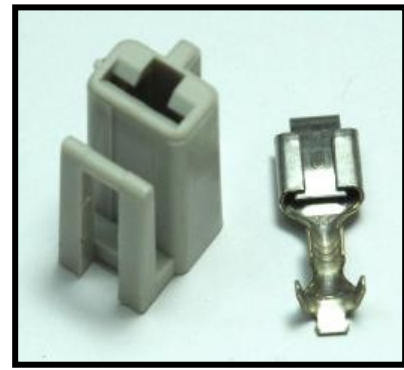

Terminals and a factory style connector, seen in the photo at right, have been supplied to allow connecting to the + side of a HEI Coil. Rollover crimpers will be used to properly install this terminal. Weatherproof insulated terminals have been supplied in the parts kit to make connections to other coils.

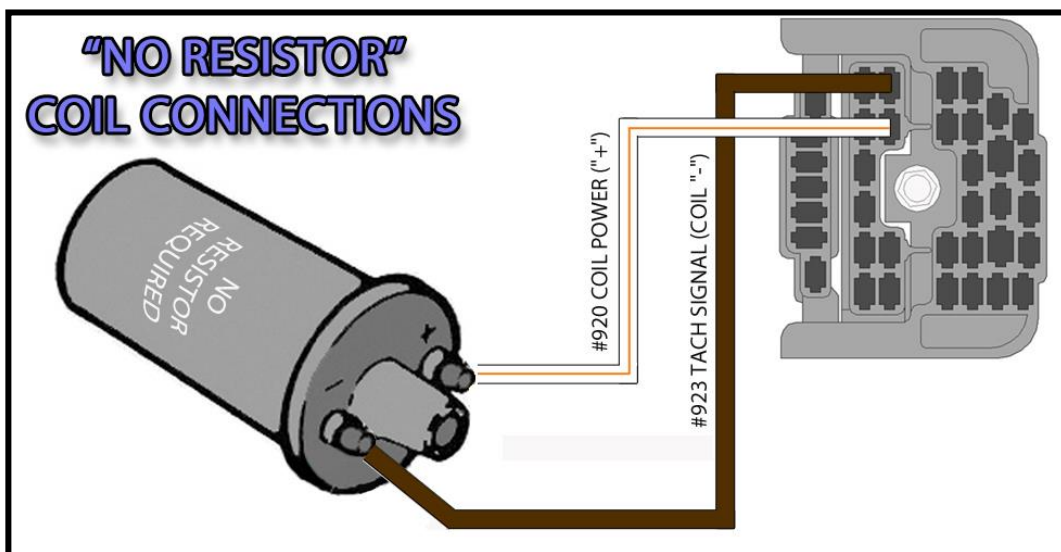
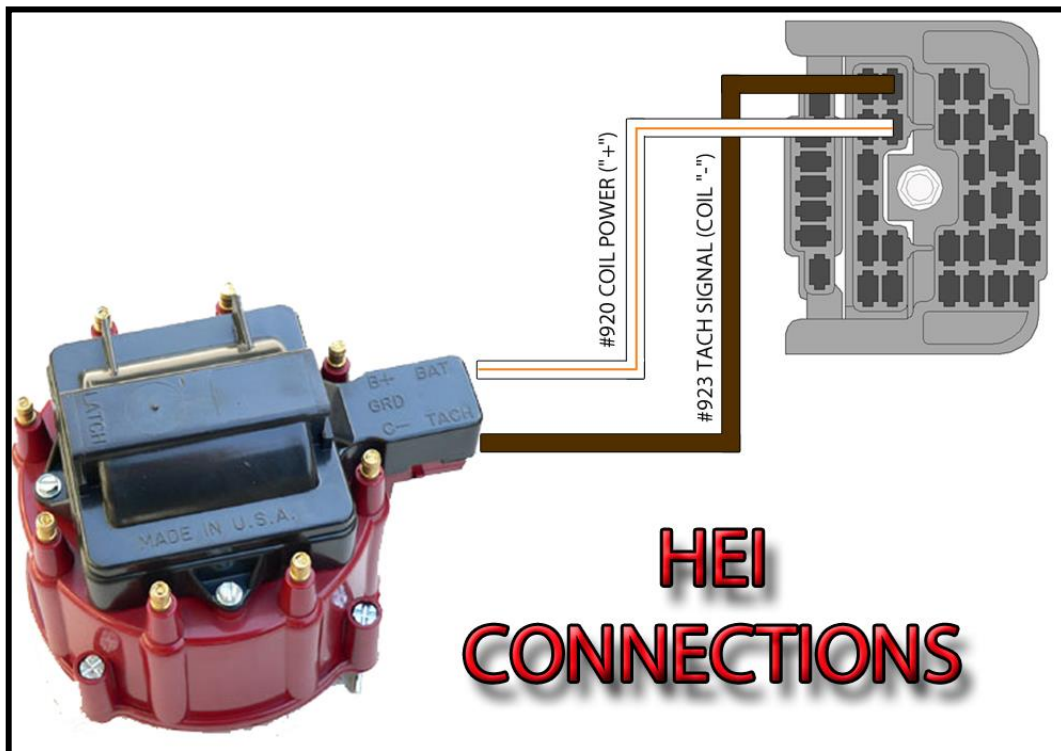

Aftermarket Ignition Box

- If an aftermarket Ignition box is being used, like an MSD, Accel, etc., this White/Orange #920 wire will supply the Ignition box with the switched power source it requires. **This wire will go to the aftermarket ignition box and not to the Coil**; the Ignition Box will provide the Coil + connection. This White/Orange #920 wire may need to be pulled from the **Engine/Ignition Section** and routed to where the box is mounted; extra length has been added to the #920 wire to accommodate different mounting locations of the box in the engine compartment. See the Ignition box manufacturer's instructions for a specific connection point of this power source. See [MSD Ignition Connection](#) below.

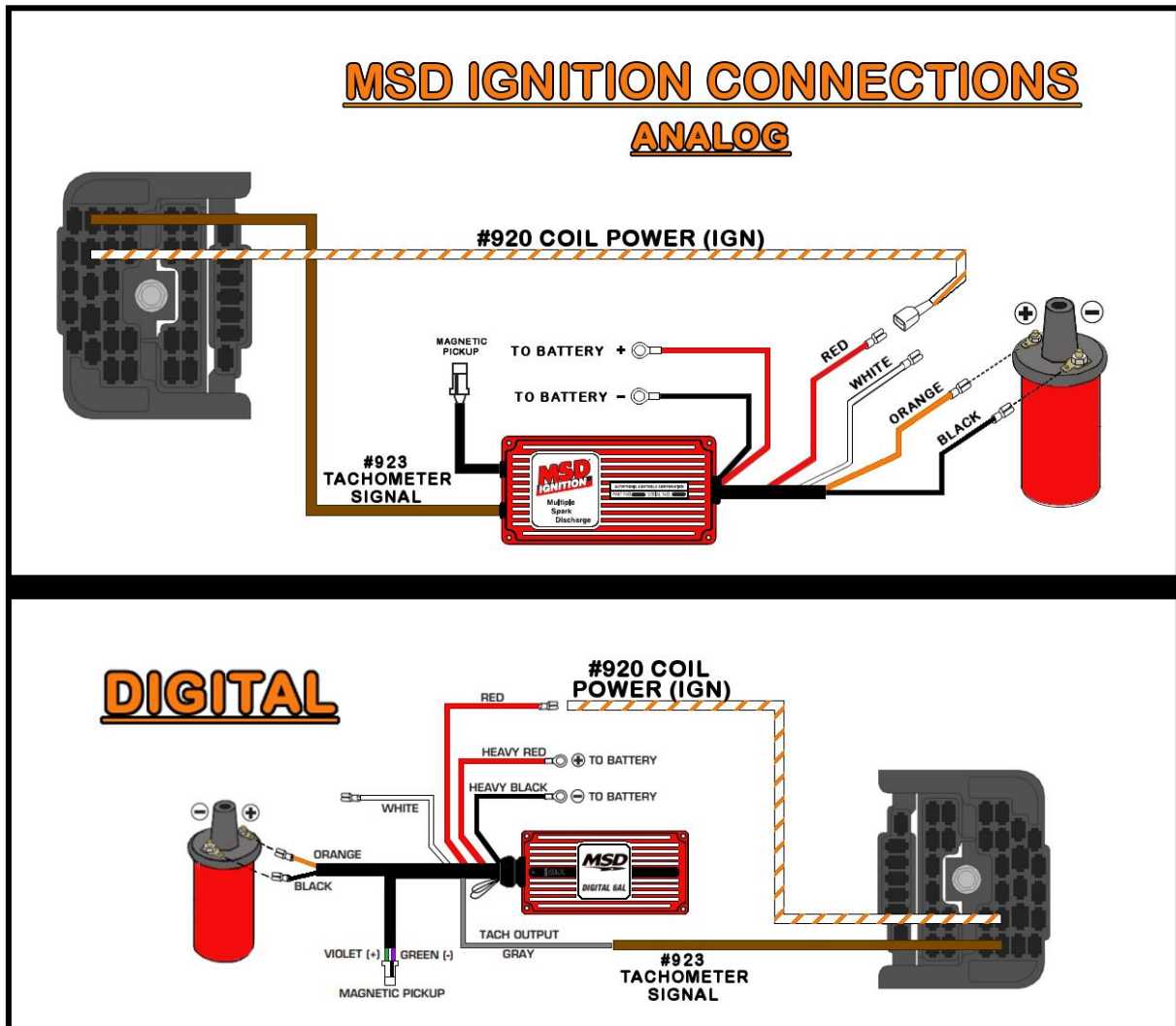

Fuel Injection

- If you have converted to fuel injection and are using a standalone harness, like all of Painless' fuel injection harnesses, and coil power is supplied through the fuel injection harness. This White/Orange **#920** wire will provide the fuel injection harness with the switched power source the harness requires. If using a Painless fuel injection harness, this White/Orange **#920** wire will connect to the open ended Pink wire of the fuel injection harness labeled "IGN" or "Fuse Block IGN".



Painless offers numerous stand-alone fuel injection harness that will allow the transplant of just about any factory GM fuel injection into your Chevelle:

- **TPI Vortec LT1 LS1 LS2 LS3**
- **Gen III 4.8/5.3/6.0 & Gen IV 4.8 / 5.3 / 6.0 / 6.2**

[Go to PainlessPerformance.com](http://PainlessPerformance.com) for details

"Tachometer"

Locate the 18 gauge Brown wire printed **#923 TACH SIGNAL (COIL "-")**. This wire will send tachometer signal through the bulkhead into the interior of the vehicle to the gauge cluster. This wire will only be connected if you are using a tachometer (factory or aftermarket). If you do not have a tachometer, this wire may be removed from the harness. Depending on your ignition system (factory or aftermarket) or use of fuel injection, the connection of this **#923** wire can vary:

- Standard factory type of installs with a HEI distributor or external coil ignition systems, will require this **#923** wire to be connected to the negative "-" side of the coil. Refer to the schematics on [pages 39 & 40](#) that best fit your application.



Terminals and a factory style connector have been supplied to allow connecting to the - side of a HEI Coil, seen in the photo at right. Rollover crimpers will be needed to properly install this terminal. Insulated terminals in the parts kit have been supplied to make other the connection to other coils.

- If an aftermarket ignition box is being used, like an MSD, Accel, etc., this **#923** wire will connect to the tach output found on the ignition box. Refer to the [MSD Ignition Connection](#) on the previous page and to the ignition manufacturer's installation procedure.
- If you are running fuel injection and your ECM has a tach output wire, this **#923** wire will connect to the tach output wire from the ECM.
- Route this **Brown #923** tach signal wire to its proper connection point and cut to length, install the appropriate terminal for your connection, and connect.

If a tachometer isn't being used, and there is no plan for one, this wire can be removed from the harness.

Alternator Section

The **Alternator Section** consists of 2 wires for connections to the alternator. All wires for an external voltage regulator are not supplied. Instructions on [page 49](#) are supplied describing how to connect the two wires of this section as well as how to add additional wires to make a connection to an external voltage regulator.

“Alternator”

Locate the two wires intended for alternator connections; they will be grouped together with a labels reading “ALT”. These wires are:

Red: 14 gauge wire, printed **#995 REGULATOR BATTERY POWER**, this wire will provide a battery power source, or amperage sample that some alternator voltage regulators require. This wire will have power at all times and comes from the large battery supply splice in the harness. **This wire will not be needed if you have a one wire alternator or any of the CS series alternators.** See [Charge/Battery Power Schematic](#) on [page 52](#).

Brown: 16 gauge brown wire, printed **#914 ALTERNATOR EXCITER**, this wire will have switched ignition power directly off the ignition switch. **This wire will not be needed if you have a one wire alternator.**

1968 Chevelles originally had an external voltage regulator, however most have been changed over to the internally regulated 10-SI or 12-SI alternator. If your vehicle has had a fuel injection motor swap or has had the accessory brackets updated to a serpentine system, your vehicle will likely have a newer style alternator: CS-130, CS-144, or CS-130D.

The alternator connections will vary depending on the alternator your vehicle currently has installed. Identify the group of instructions on the following pages that fit the alternator your vehicle has. The alternator may also need to be removed in order to gain access to the connection points.

- If the alternator needs to be removed, before removing the alternator from the accessory bracket, route the alternator wires to their connection points and cut to length.
- Using the supplied instructions on the following pages, connect the **#995** and **#914** wires to the Alternator or external regulator.
- If a one wire alternator is being used, these wires will not be needed, refer to the next page on what to do with these two wires.

Locate the bag kit provided with the Painless harness labeled “ALTERNATOR”. This bag kit will contain hardware needed to make the appropriate connections to the alternator as well as contain a covered inline fuse holder.



The one connection all alternators will have in common is the output post. This will send amperage from the alternator to the battery. Locate the large gauge wire supplied separately with this harness. This wire is:

Red: 6 gauge wire, with a label printed **#915 ALTERNATOR OUTPUT**, this wire will provide power out of the alternator to the chassis harness and back to the battery through the MIDI fuse. This wire See [Charge/Battery Power Schematic](#) on [page 52](#).

- Locate the rubber alternator boot and a large un-insulated ring terminal from the “ALTERNATOR” bag that has the right size opening for your alternator post. The piece of red heat shrink may be used over the terminal crimp if the alternator boot is not desired.
- If the rubber boot is being used, the end will need to be cut as shown in the photo below to allow the large gauge wire to pass through.



A very small amount of lubricant like WD-40 or motor oil may be applied on the inside of the rubber boot to allow the boot to slide down the wire easier.

- If you are using a Painless harness, that has a charge wire provided as is the case with many of our “LSX” harnesses, the **#915** wire will not be needed, use the charge wire supplied with the fuel injection harness.
- With the boot on, strip about 3/8” of insulation from the charge wire and crimp the ring terminal on. You can use a pair of pliers and solder if your crimpers will not accept this large gauge wire/terminal.

If solder is used, do not over heat the wire, it will make the connection brittle and prone to failure.

- Connect this wire to the B+/Output stud on the Alternator. Once the nut is on the output post has been tightened, the boot can now be slid up the wire to cover the nut and ring terminal installed on the Alternator.

Once connected, this output wire will need to be routed to the back of the engine and across the firewall to the passenger side of the vehicle. It will be connected to the inline MIDI fuse as explained later in this manual on [page 50](#).

The remaining alternator connections will vary based on what alternator is being used. Choose the alternator that best represents the alternator found on your vehicle from the 10-SI, CS-130 and CS-130D information on the next few pages and follow the instructions provided for your particular alternator



One Wire Alternator

If your vehicle has an aftermarket one wire alternator or if the Painless or other aftermarket fuel injection harness you are using has an alternator connector, then this output wire, **#915**, is the only wire used to make the alternator connection.

The two wires, labeled "ALT," a 14 gauge **red** wire printed **#995 ALTERNATOR BATTERY POWER SAMPLE** and a 16 gauge **brown** wire labeled **#914 ALTERNATOR EXCITER**, can be removed from the harness. **#995** may be connected to the output post of the alternator with the **#915** output wire to avoid removing it from the harness since this wire goes into the big battery power splice.

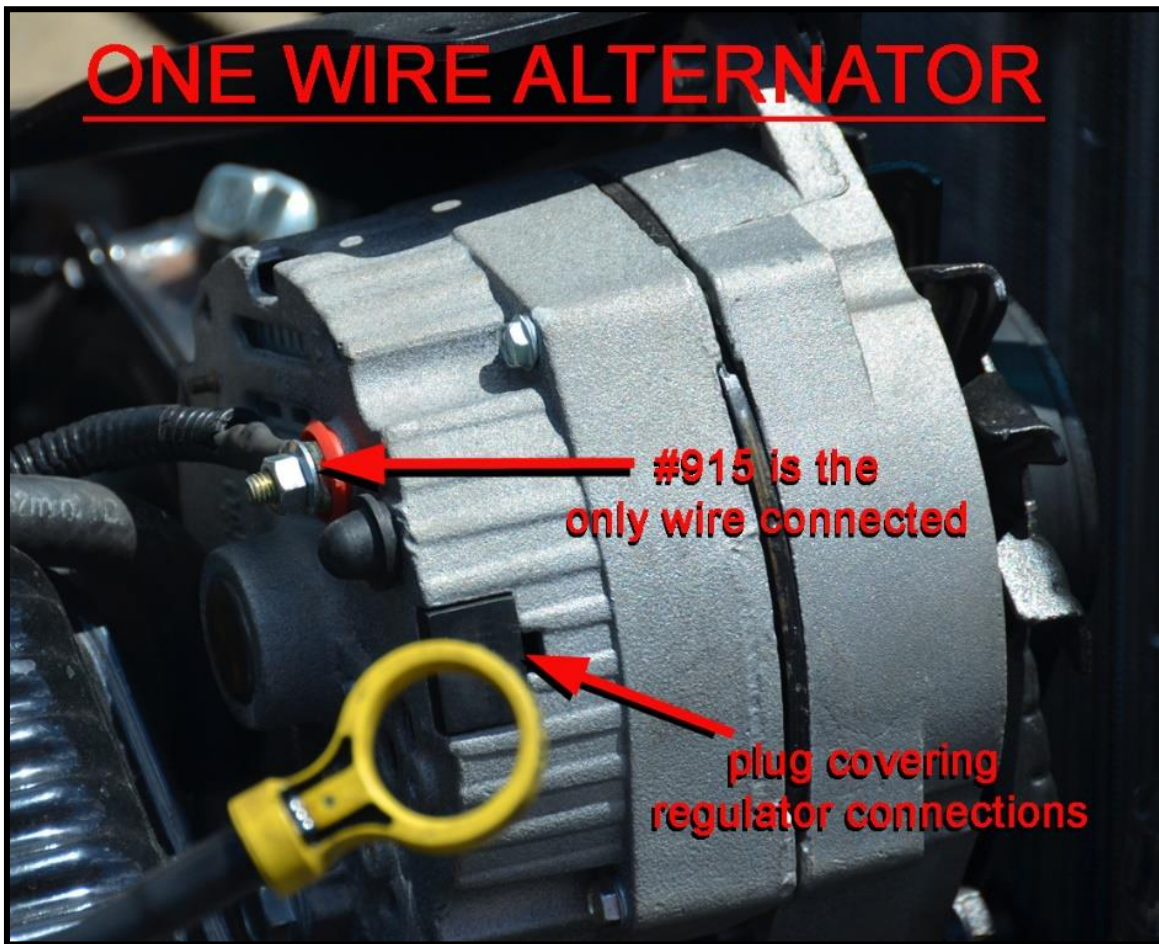

SI Series Alternators

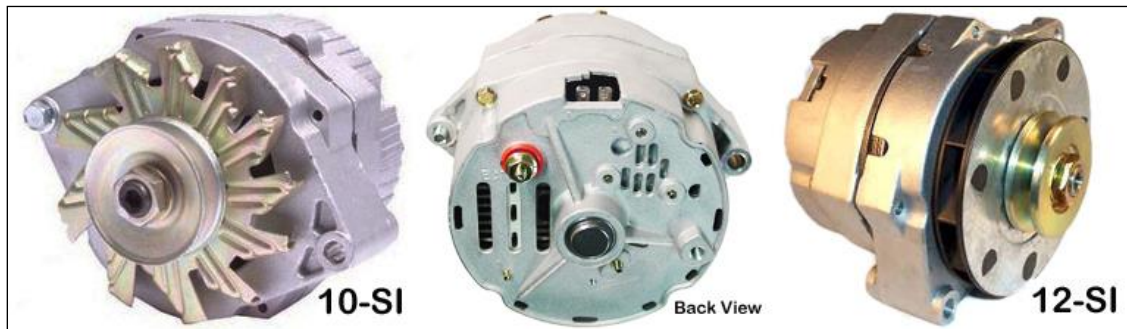

The 10-SI and 12-SI alternators are easy to identify. They will have an external fan behind the pulley, the 12-SI having enclosed style fan blades, and a two pin connection. This 2 pin connection can be seen on the middle image in the diagram above. These are also known as “Delco” or “Delcotron” alternators.

The two remaining wires, a 14 gauge **red** wire printed **#995 REGULATOR BATTERY POWER** and a 16 gauge brown wire labeled **#914 ALTERNATOR EXCITER**, will connect to the two posts on the back edge of the alternator.

- Route the two wires to the 1 & 2 terminals on the alternator and cut to length. Strip ¼” of insulation from both wires.
- A factory style connector and terminals, seen in the photo, have been provided in the “ALTERNATOR” bag. Crimp a terminal onto each of the two wires.



In some cases, engine run on may be experienced during initial testing of a new harness install. This is caused when the alternator back feeds voltage down the **#914** wire after the key has been turned off. If this should happen, unplug the alternator connector to shut the engine off.

If engine run on occurs, simply install the diode as shown below. When the diode is installed inline of the **#914** wire **with the stripe towards the alternator**, the diode will let voltage flow towards the alternator, but not away from the alternator towards the ignition system. This diode can be installed during connection of the **#914** wire as a precaution without causing any unwanted side effects. However, if the diode is installed backwards, the alternator will not charge.

- Insert the wires into the connector as shown in the diagram below. When terminal pin-out is complete, plug the connector into the alternator.

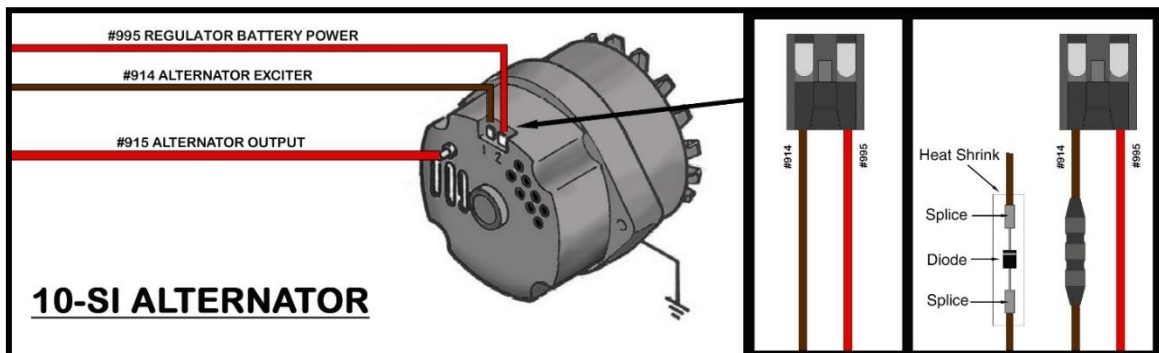

CS-130 Series Alternators



The CS-130, CS-121 and CS-144 alternators closely resemble the SI series alternators. They will have an external fan behind the pulley and they generally have some plastic casing on the side and back. These alternators have a four pin sealed connector, seen in the photo below and in the middle image above. The regulator will be marked P, L, S, F. This type of alternator was used on GM TPI and LT1 fuel injected engines among other late 1980's to mid-1990's GM vehicles.

The two remaining wires, a 14 gauge **red** wire printed **#995 REGULATOR BATTERY POWER** and a 16 gauge **brown** wire labeled **#914 ALTERNATOR EXCITER**, will connect to the regulator on the back of the alternator.

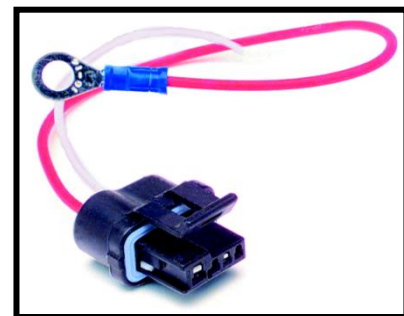

- Route the two wires to the connector on the alternator and cut to length. Strip $\frac{1}{4}$ " of insulation from both wires.
- The 4-pin alternator connector from the harness removed from the vehicle prior to installation of the Painless harness (see photo), will need to be used. Due to a lack of usage by most customers it is not included with this Painless chassis harness.
- **The CS-130 alternator requires a resistance on the #914 wire. Without this resistance the regulator on the alternator will burn up.** A resistor, splices, and heat shrink, seen in the photo, have been provided in the "ALTERNATOR" bag kit. The resistor* will simply need to be installed inline on the **#914** wire as shown in the diagram on the next page.
- Using two of the splices and heat shrink provided in the "ALTERNATOR" bag kit, splice the CS-130 pigtail to the **#914** and **#995** wires according to the diagram on the next page.

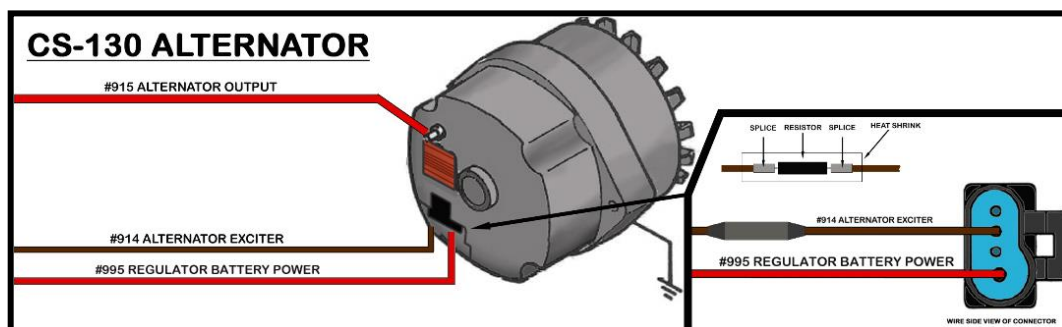
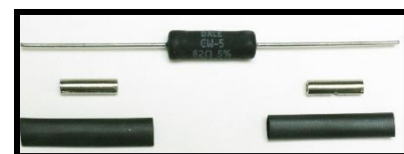

CS-130D Series Alternators

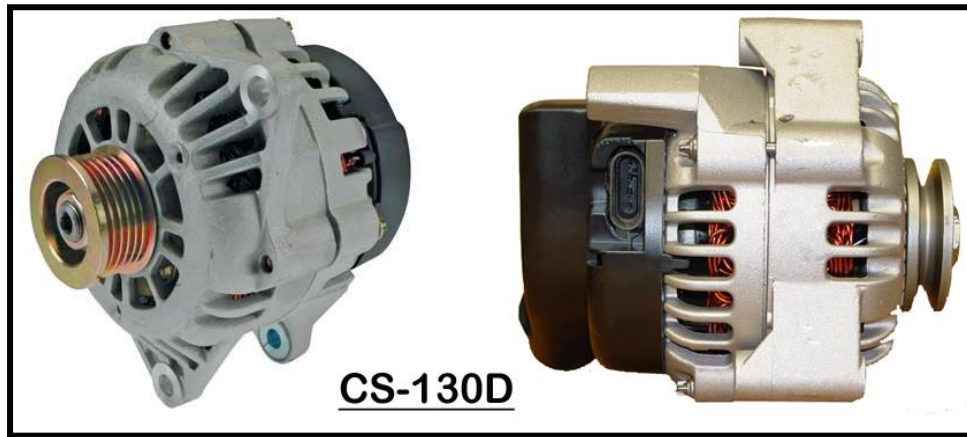

The CS-130D can be spotted by their lack of an external fan behind the pulley. These alternators have an internal fan. They also have a plastic casing on the back. These alternators have an elongated oval, four pin sealed connector, seen in the photo below and in the image above. The regulator will be marked P, L, I, S. This type of alternator was used on many engines, including the GM LS series, Vortec and Gen. III Vortec truck fuel injected engines.

Of the two remaining wires, a 14 gauge red wire printed **#995 REGULATOR BATTERY POWER** and a 16 gauge brown wire labeled **#914 ALTERNATOR EXCITER**, only the **#914** will be used. The **#995** may be connected to the alternator output post or removed from the harness.

- Route the brown **#914** to the connector on the alternator and cut to length. Strip $\frac{1}{4}$ " of insulation.
- The 4-pin alternator connector from the harness removed from the vehicle prior to installation of the Painless harness or a CS-130D pigtail purchased from Painless, [part # 30708](#) (see photo), will need to be used. Due to this connector being provided on most fuel injection harnesses, this connector is not included with this Painless chassis harness.



- The CS-130D alternator requires a switched power source to pin I of the regulator, and a resistance on the wire going to pin L of the regulator, the brown wire in the photo on the previous page. Without this resistance the regulator on the alternator will burn up. A resistor, splices, and heat shrink, seen in the photo, have been provided in the "ALTERNATOR" bag kit. The resistor will simply need to be installed inline on the L pin wire as shown in the diagrams below.

- Using a splice and heat shrink provided in the "ALTERNATOR" bag kit, splice the CS-130D pigtail to the brown **#914** wire according to the diagram below and on the next page that best reflects your application.

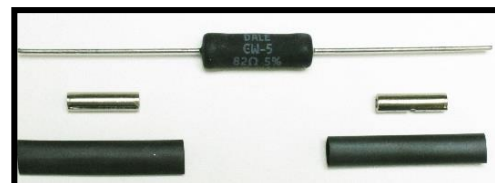

Both diagrams accomplish the same task, using the brown **#914 ALTERNATOR EXCITER** wire to provide a switched power source and a resisted power source to the 2 wires of a CS-130D alternator pigtail/connector. The pink wire shown in the diagrams is an installer supplied wire, this will generally be a wire coming from an alternator pigtail. Of the two diagrams below, pick the method that easiest for you to understand, the only difference between the diagrams is how many splices are used.

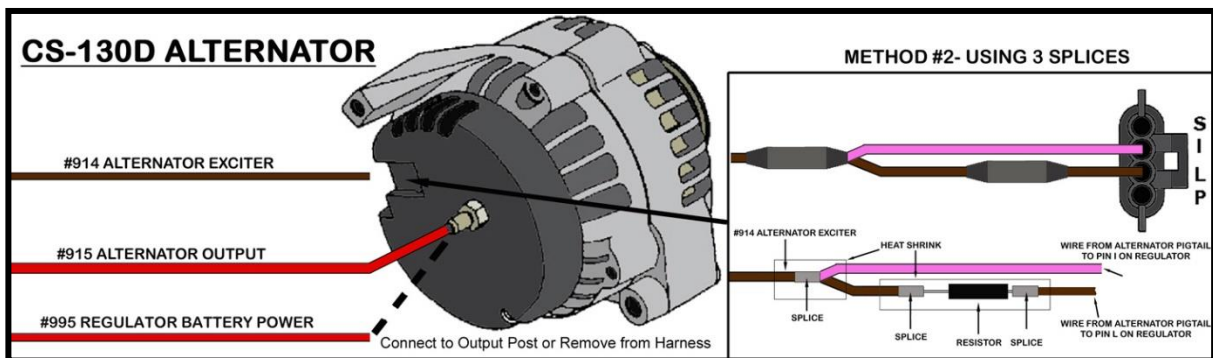
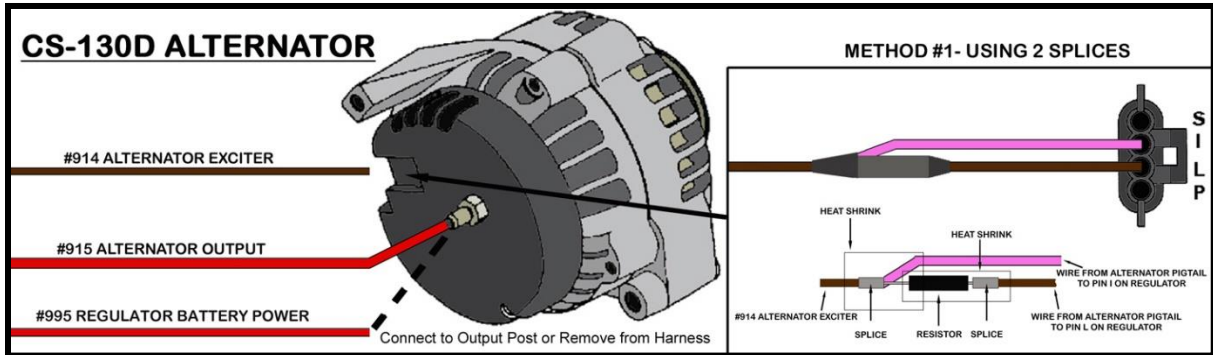

Externally Regulated Alternators

The 1968 Chevelle left the factory with an external voltage regulator mounted on the core support. To connect to the regulator in the factory location, the wires described below will need to be routed with the Light Section wires down the driver side inner fender to the core support. Along with these two wires, the **#995** and **#914**, two other wires, blue and white in the diagram below and not supplied, will need to be added to the harness.

The two remaining wires, a 14 gauge red wire printed **#995 REGULATOR BATTERY POWER** and a 16 gauge brown wire labeled **#914 ALTERNATOR EXCITER**, will connect to the regulator.

- Route the two wires of the Painless harness to the connection point on the regulator and cut to length. Strip ¼" of insulation from both wires.
- The four pin regulator connector and the two pin alternator connector from the harness removed from the vehicle prior to installation of the Painless will need to be used. Due to a lack of usage by most customers these connectors are not included with this Painless chassis harness. If you do not have these connectors they can be obtained online or at a local auto parts store, or you can use the loose piece insulated terminals in the parts kit to make connections.
- Connect the brown **#914** wire to the "4" terminal on the regulator.
- Connect the red **#995** to the "3" terminal on the regulator, from the factory this would have been an orange wire.

Two 14 gauge wires which run from the regulator to the alternator and a 14 gauge wire for a ground will need to be provided by the installer to finish the connections. These wires are not in the Painless harness.

- Connect the "2" terminal on the regulator to the "R" terminal on the alternator. This was a white wire from the factory.
- Connect the "F" terminal on the regulator to the "F" terminal on the alternator. This was a blue wire from the factory.
- The last connection will be connecting a wire from the "G" post on the alternator to a chassis ground source.

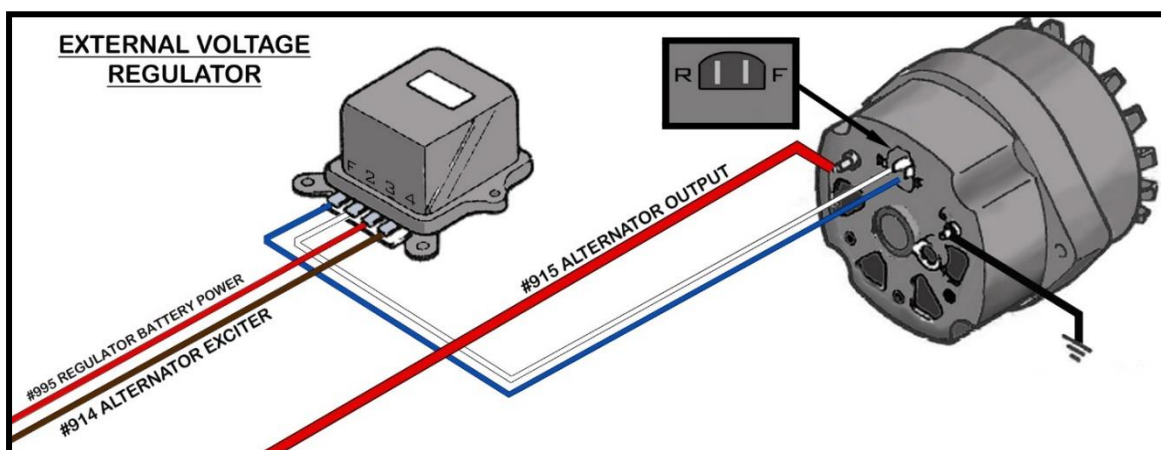

“MIDI Fuse”

A large in line MIDI fuse has been included in the “Alternator” bag kit. This inline fuse will provide a fused link between the alternator and battery.

- Find a suitable location to mount the supplied fuse holder using the 2 of the self-tapping screws provided. On the firewall, as seen in the photo below, above the passenger side valve cover is a nice place that has easy access.
- Route the large **#915** wire that is attached to the output of the alternator to one side of the fuse holder and cut the wire to length. **DO NOT DISCARD THE CUT OFF PORTION OF #915.**

The length of excess wire cut from the #915 wire will be used to connect the other side of the fuse to the “+” side of the vehicle’s battery or to the battery post on the starter solenoid. **DO NOT CONNECT THE #915 TO THE ACTUAL BATTERY AT THIS TIME.** If routed to the starter solenoid, this wire will NOT replace the battery cable needed by the starter from the positive side of the battery to the “BAT” or + post of the starter solenoid.

- Connection to both sides of the fuse holder will be made using the large ring terminals with the small #10 hole provided with the kit. You can use a pair of pliers if your crimpers will not accept this large gauge wire/terminal. The heat shrink supplied with this kit is intended to cover the crimped end of each of these two ring terminals. A schematic showing these connections can be found on the [page 52](#).

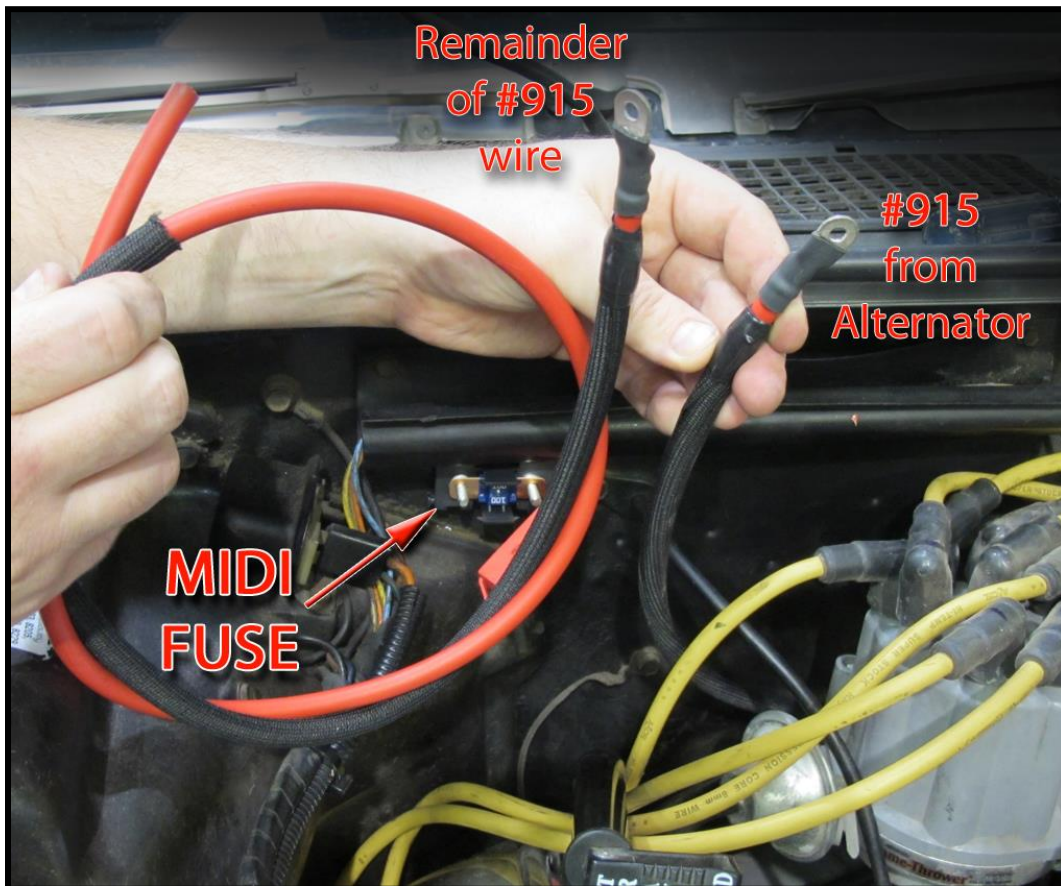

- Remove the 2 nuts on the studs of the fuse holder and install the 150 amp fuse provided in the “Alternator” bag kit. *The **#915** wire that will connect to the battery or starter solenoid can be installed onto the fuse at this time and the nut can be installed and tightened onto the holder stud. Remember to route the remaining end of this **#915** wire to either the battery lug or to the starter solenoid.

* Those with factory A/C, connect the black wire you removed from the horn relay, see [page 19](#), to the same side of the MIDI fuse as the power wire from the starter or battery. Ring terminals are provided in the parts kit, to cut this black wire to length. This will supply power to the blower motor relay, the factory inline glass fuse on this A/C wire will need to be reused.



Before the **#915** coming from the alternator is installed onto the fuse holder, the harness power wire will need to be routed, cut to length and terminated, this wire will be found in the **Starter Section**.

Starter Section

This section will consist of two wires that provide power to the harness and a start signal to the starter solenoid. These two wires will be grouped together with a label reading “Starter”. Let’s first address power to the harness this wire is:

Red: 8 gauge charge wire with the label reading **#916 BATTERY POWER SOURCE**. This wire will feed the harness, fuse block, and ignition switch battery power. See [Charge/Battery Power Schematic](#) on the next page.

- Route the **red #916** wire to the MIDI fuse holder and cut to length. Install one of the #10 ring terminals from the “Alternator” bag to connect this wire to the fuse holder.
- Install this wire, along with the **#915** wire coming from the alternator to the same side of the fuse holder, this will be the opposite side of the holder from the wire going to the starter or battery. See [Charge/Battery Power Schematic](#) on the next page for a visual of this connection.

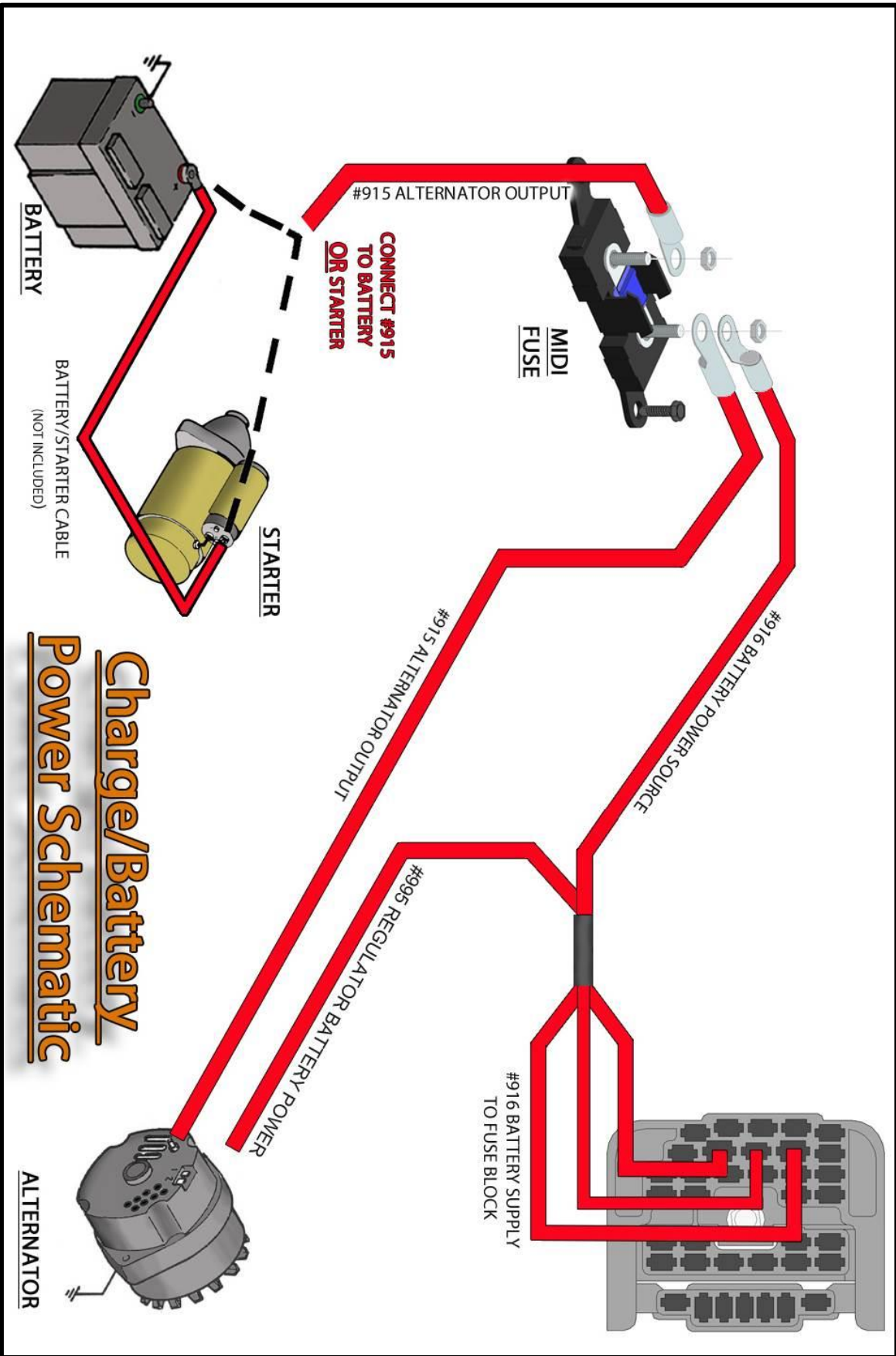

The other wire in the group labeled “Starter” is the wire used for actual starter engagement. This wire is:

Purple: 12 gauge wire, printed **#919 STARTER SOLENOID "S" (START SIGNAL)**, this wire will supply the solenoid with a switched power source from the ignition switch. This power will activate the starter solenoid causing it to turn the engine over for startup. This wire will only have power when the ignition switch is in the *Start/Crank* position.

- Route the purple **#919**, and the **YELLOW #970** (if used, connected at the ballast resistor/coil on [page 39](#)), to the starter solenoid and cut to length. If the remainder of **#916** from the MIDI fuse is being connected to the “BAT” or + post of the starter solenoid it may be routed at this point as well. Be sure to keep all wires away from the exhaust manifold or header.
- Locate the heat shrinkable ring terminals from the parts kit that best fit the posts found on the starter solenoid and install onto the wires going to the starter solenoid. Be sure to apply heat to shrink the insulation to protect the crimp.

The **PURPLE #919** wire will connect to the “START” or “S” post on the solenoid and the **YELLOW #970** wire will connect to the “I” or “R” post of the solenoid, as seen in the schematic below.

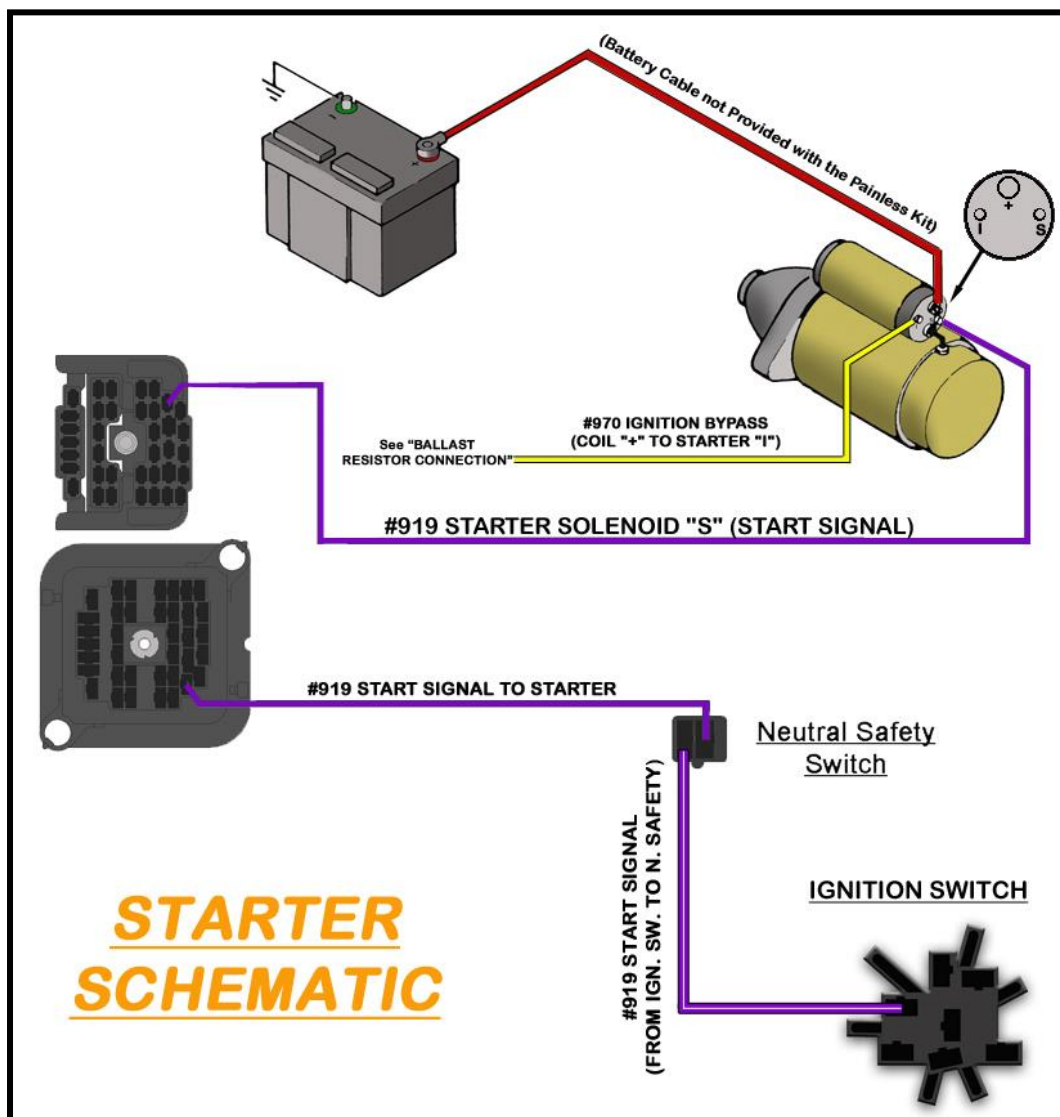

Blower Motor

A single wire is supplied to connection to the blower motor. This wire will only be needed by those with factory heater only (non A/C) vehicles. Cars with factory or aftermarket air conditioning will not need this wire and it may be removed from the harness.

Locate the single orange wire with a section label reading “Blower Motor”, this wire will be:

Orange: 12 gauge wire printed **#967 BLOWER MOTOR POWER**. This wire will provide power to the blower motor from the blower switch. A [Heater Only Schematic](#) showing this wire can be seen on [page 82](#).

- Route the **#967** wire towards the blower motor cut to length and install the terminal and connector seen in the photo.
- Connect the **#967** wire to the top terminal on the blower motor, this will be the power terminal. The bottom terminal will connect to ground. This ground wire is not included with the Painless harness because it was a dedicated ground and not part of the factory chassis harness.

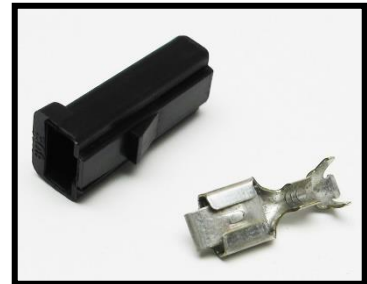

This completes the Engine Section wiring.

INTERIOR HARNESS

In order to properly route and connect the interior harness, it is recommended that the kick panels, gauge cluster, radio, glove box, driver door sill plate, driver seat/bench seat, and rear seat and seat back be removed. This will allow plenty of access to all installation points and areas where routing will take place to properly install this Painless harness.

The interior harness is broken down into breakouts throughout the dash. These breakouts correspond to the components they connect to as you move from left side of the vehicle or driver side to the right side, passenger side.

- Driver side kick panel and left of the steering Column - contains wiring for the dimmer switch, emergency brake switch, driver door jamb switch, tail harness connection, courtesy light, headlight switch, wiper switch and wiper ground.
- Steering column area - contains wiring for the ignition switch, turn signal switch, neutral safety switch, reverse switch, console, cigarette lighter/power port, and gauge cluster connections
- Radio/Glove box/ Pass. side kick panel area - contains wiring for the radio, aftermarket gauge connector, heater/Ac panel, glove box light connector, a courtesy light, and passenger door jamb switch
- Begin by loosely routing the interior harness over the steering column and towards the passenger side of the vehicle just as the factory harness was routed.

The driver side kick panel area connections such as the driver side door jamb switch and driver side courtesy light will **NOT** route over the column. A piece of loom, different from that shown below, has been pre-installed on the harness to help protect the harness from any rubbing or chaffing on the steering column support.

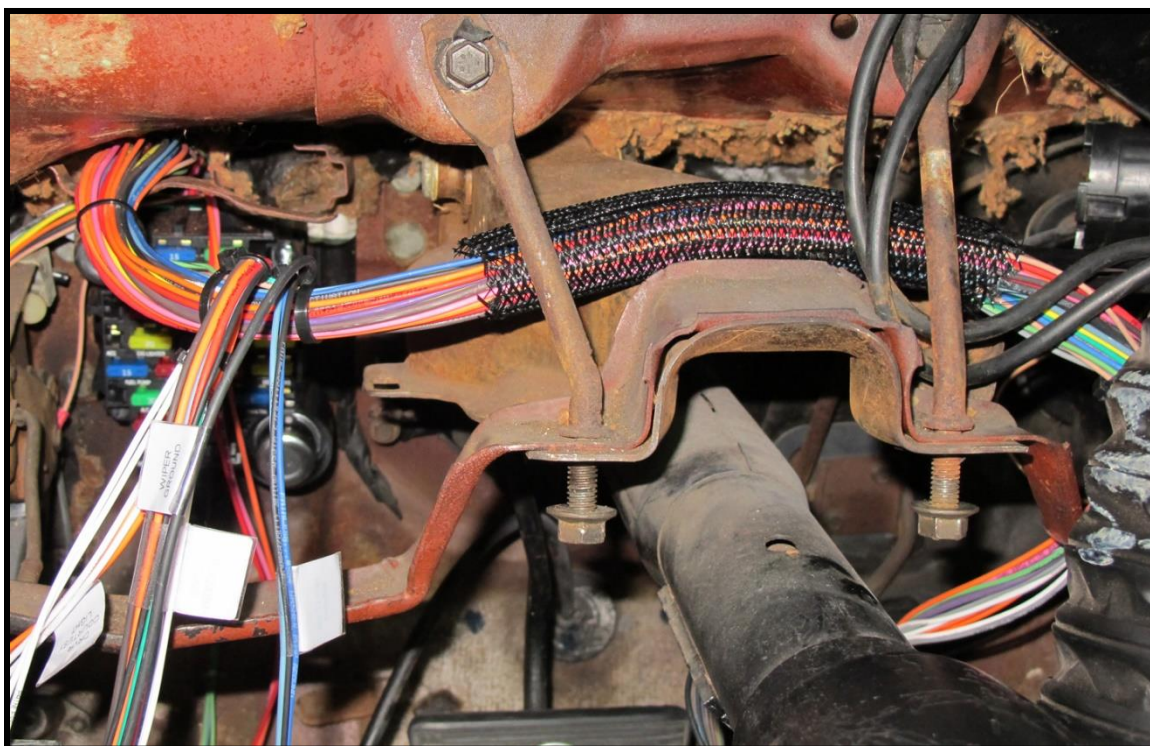

The following instructions will be in the order you come across connection points of the Painless harness as you move across the dash starting at the fuse block and working your way across the harness to the passenger side.

Dimmer Switch

The dimmer switch can be found mounted on the floorboard next to the driver side kick panel. The dimmer switch receives power from the headlight switch and based on the position of the switch will send power out the low beam or high beam wire.

Coming out of the bottom of the fuse block you will notice wires grouped together with a section label reading "DIMMER SWITCH". These wires have a large black 3 pin connector preinstalled. The three wires that make up the connection to the dimmer switch can be seen in the [Front Lighting Schematic](#) on [page 32](#), they are:

Light Blue - 14 gauge wire printed **#907 DIMMER SWITCH POWER**, this comes from the headlight switch and will have power whenever the headlight switch is in the *ON* position.

Tan - 14 gauge wire printed **#909 LOW BEAM POWER**, this wire provides power through the bulkhead to the low beam filament of the headlights whenever the dimmer switch is in the low beam position and the headlight switch is in the headlights ON position.

Light Green - 14 gauge wire printed **#908 HIGH BEAM POWER**, this wire provides power through the bulkhead to the high beam filament of the headlights as well as power to the high beam indicator in the dash whenever the dimmer switch is in the high beam position and the headlight switch is in the headlights ON position.

- Remove the two screws holding the dimmer switch to the floor board if it is currently mounted.
- Plug the black three pin connector onto the dimmer switch, you will notice the connector will also go underneath the switch and will line up to the mounting holes.
- Using the original screws or two of the black $\frac{3}{4}$ " self-tapping screws found in the parts kit, mount the dimmer switch to the floor board. There should be adequate length on the wires to enable you to re-use the existing holes in the floor.

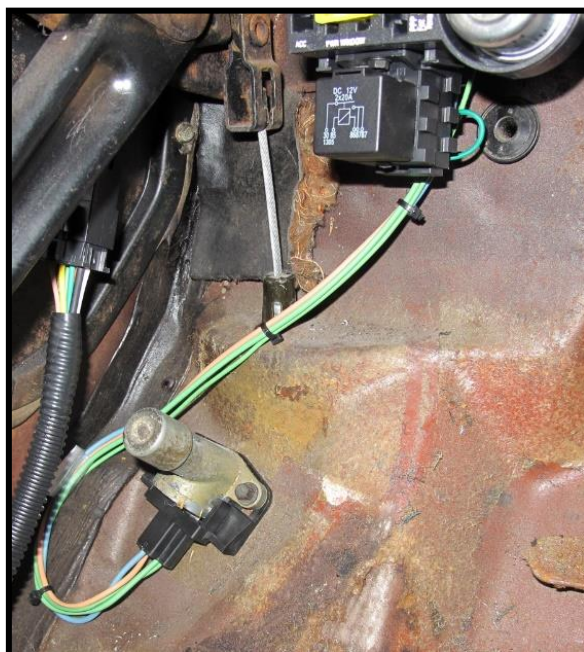

Emergency Brake Switch

Of the wires coming out of the top of the fuse block the first connection you come to is a wire labeled "E BRAKE". This connection is for the emergency brake switch which activates the brake indicator light on the dash.

For those that are using aftermarket gauges and do not have a brake indicator light, this wire will have no function and can be removed from the harness.

This connection will be one wire and will have an insulated terminal pre-installed; this wire is:

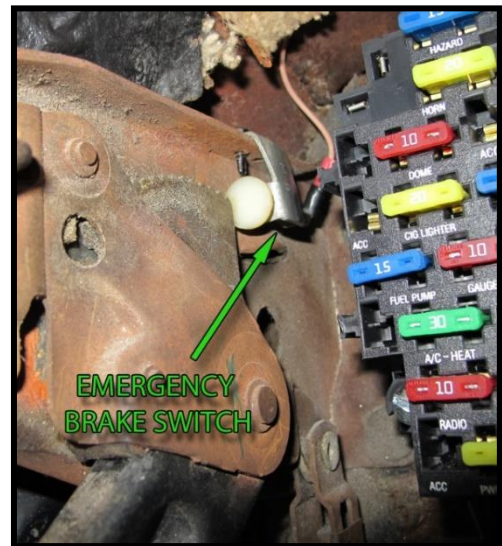

Tan: 18 gauge wire, printed **#968 EMERGENCY BRAKE SWITCH**, this wire sends a ground source to the brake warning light in the dash, causing it to turn on when the emergency brake pedal is down. This wire can be seen in the [Gauge Cluster Schematic](#) on [page 94](#).

- Route the tan/white **#968** wire to the emergency brake switch found next to the driver side kick panel on the side of the emergency brake pedal bracket and connect.

To facilitate making this connection, remove the switch from the emergency brake; there is a single bolt or screw found on the top. Removing the switch will also allow you to clean the mounting point on the emergency brake lever body, as well as the contact points of the switch. Cleaning can be done by using a rough sandpaper or wire wheel on a drill. Doing so will help provide a clean ground source to the brake warning light and may save you some trouble shooting when testing the system upon installation completion.

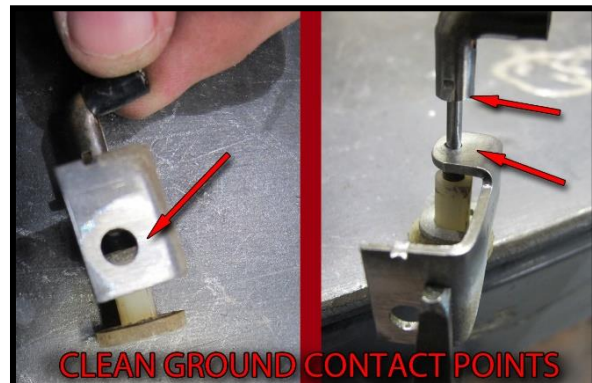

Tail Section

We will bypass this connector at this time, the tail harness supplied with this kit will plug into this connector, however, this will be done after all the interior connections have been made. This connection will be handled on [page 104](#) of this manual.

ACC Section

A section of wires with a label reading “ACC”, short for Accessory, will contain three wires and will be found in a rolled up bundle. These wires are labeled for use for power window, power lock, and an electric fuel pump. In most cases, these wires will be routed away from their current location to components, hence the extra length. These wires can also be used to power other components if power windows, locks, or an electric fuel pump are not used. **READ THE FOLLOWING INSTRUCTIONS REGARDLESS IF YOU NEED THESE WIRES AT THIS TIME.**

Power Window & Power Lock

There are two wires provided in the Painless harness for connection to power windows and power locks. These two wires will provide battery power for power locks, and ignition switched power, for power windows. These wires can be used with a factory power window/power lock harness or can be connected to aftermarket systems.

If your vehicle is not equipped with these options, the ends of the wires will need to be insulated and the fuses removed from the fuse block or the unused power window/power lock circuit(s) can be used to provide power to other components. You will need to replace the fuse at the fuse block of which ever circuit you are using to match the amperage rating of the component you are connecting it to. **These wires are not to exceed 30 amps.**

The two wires intended for power window & power lock are:

Orange: 14 gauge wire printed **#910 POWER LOCK POWER SOURCE (BATTERY)**. This wire comes from the 30 amp Power Lock fuse on the fuse block and is a constant battery power source, as indicated by “(Battery)” being printed on the wire. This wire will have a single pin white connector pre-installed and can be seen in the [Accessory Schematic](#) on [page 103](#).

Pink: 14 gauge wire printed **#911 POWER WINDOW POWER SOURCE (IGN)**. This wire comes from the 30 amp Power Window fuse on the fuse block and is an ignition switched power source, as indicated by “(IGN)” being printed on the wire. This wire can be seen in the [Accessory Schematic](#) on [page 103](#).

Single pin connectors and terminals, seen in the photos to the right, have been provided to allow a connection to the connectors found on the power lock/power window wires of the factory harness. These connectors will allow you to make a factory style connection to your factory power lock/power window harness, to aftermarket power lock/power window harnesses, or to a component you may be powering with one of these circuits.



- For those installing aftermarket power locks, connect the Orange **#910** wire to the wire or switch/relay input that requires a fused battery power source.
- For those installing aftermarket power windows, connect the pink **#911** wire to the wire or switch/relay input that requires a fused switched ignition power source

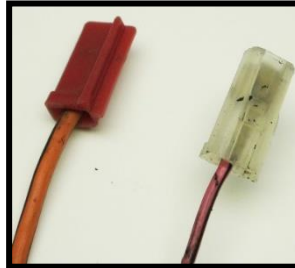
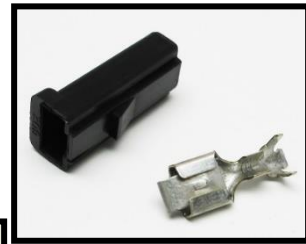

For those reusing the factory power harness, the following set of instructions slightly modify the original harness to work harness.

lock/power window will be used to with the Painless

- Begin by locating the two connectors on the factory power lock/power window harness that connected to the accessory ports at the fuse block. This will be a pink/black wire with a single pin clear connector and an orange/black wire with a red single pin connector. The pink/black provides power to the window switch. The orange/black provides power to the lock actuators in the doors. Both of these connectors can be seen in the photo to the right.

These connectors use the same terminal that is provided in the kit that mates to the power lock/power window connectors found on the Painless harness. A simple connector change is all that is needed in order to re-use the factory power lock/ power window harness with the Painless harness.

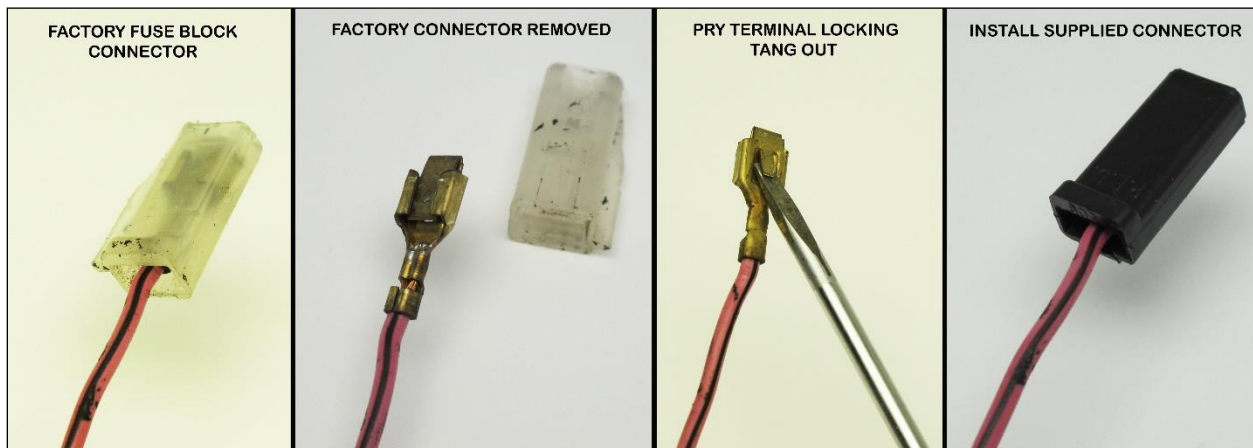

- Using the terminal removal procedure, found on [page 11](#), remove the two fuse block connectors on the factory harness. Remember to pry the locking tang of the terminal back out once the connector is removed. The factory connectors can also be cut from the original harness and the new terminals that are provided with the Painless kit can be installed.
- Install one of the single pin connectors on each of the factory wires and connect them to the Painless harness. The factory pink/black wire will connect to the power window, pink **#911**, wire on the Painless harness. The factory orange/black wire will connect to the power lock, orange **#910**, wire on the Painless harness.

Fuel Pump

The third wire in the rolled up section labeled “ACC.” is provided to allow a power connection to an electric fuel pump. This wire is:

RED: 14 gauge wire, printed **#947 FUEL PUMP POWER**, this wire will provide a power source to an electric fuel pump. This wire comes from the 15 amp “FUEL PUMP” fuse on the fuse block and will only have power when the ignition switch is in the ON/RUN position and the START position.

- If a mechanical pump is being used, insulate the end of this wire with an insulated terminal from the parts kit and tape the wire up into the harness, also remove the fuse from the fuse block, and proceed to the next connection. If an electric fuel pump is being used, route the pink **#947** wire to the power or + post/tab/wire of the fuel pump. This is usually easiest by routing this **#947** to the rear of the car with the Tail harness, as it is installed on [page 104](#). Once in the trunk area, route this **#947** out the hole in the tail panel that the fuel sending unit wire exits the trunk from.
- Using an insulated terminal that matches the connection your pump requires, connect the **#947** wire to the power or + post/tab/wire of the fuel pump.
- At this time you will need to provide a ground wire. This harness does not provide a ground wire for an electric fuel pump, but a ground can be easily connected using insulated terminals from the parts kit and a length of scrap wire created during a previous connection. Simply connection the ground or - post/tab/wire of the fuel pump to one of the mounting bolts holding the fuel pump to the frame/body.

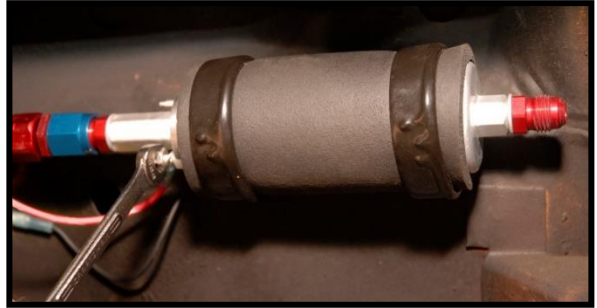

Driver Door Jamb Switch

The door jamb switches will ground activate the courtesy light sockets installed on the Painless harness. When the door is opened, the plunger on the switch extends out as it is no longer being pushed in by the door. When the plunger extends, the contact point on the back of the switch makes contact with the body of the switch, which is grounded through the mounting into the metal door jamb. This grounding gives the wires attached to the switch a ground source which will then cause the interior lights to turn on.

Locate the two wires with the section label reading “DRVR. DOOR JAMB SWITCH”. Both of these wires will have a pre-installed insulated terminal they are:

White: 18 gauge wire, printed **#961 DRIVER DOOR JAMB SWITCH**, this wire is tied to the ground side of the included courtesy lights. This wire will be grounded anytime either door is opened or when the headlight switch knob is rotated to the “Dome Light On” position. This wire can be seen in the [Headlight Switch Schematic](#) on [page 96](#) and the [Dome/Courtesy Light Schematic](#) on [page 62](#).

White: 18 gauge wire, printed **#961 DOME LIGHT GROUND**, this wire is will provide a ground source to the dome light connection found in the Tail Section of the harness. This wire will be grounded anytime either door is opened or when the headlight switch

knob is rotated to the “Dome Light On” position. This wire can be seen in the [Headlight Switch Schematic](#) on page 96 and the [Dome/Courtesy Light Schematic](#) on page 62.

- Route the white #961 wires to the driver side door jamb switch and connect to each of the two terminals. It does not matter which terminal either wire is connected to.

You may have to unscrew the door jamb switch $\frac{1}{4}$ turn in order to make the second connection to the switch. Once connected, retighten the switch in the jamb.

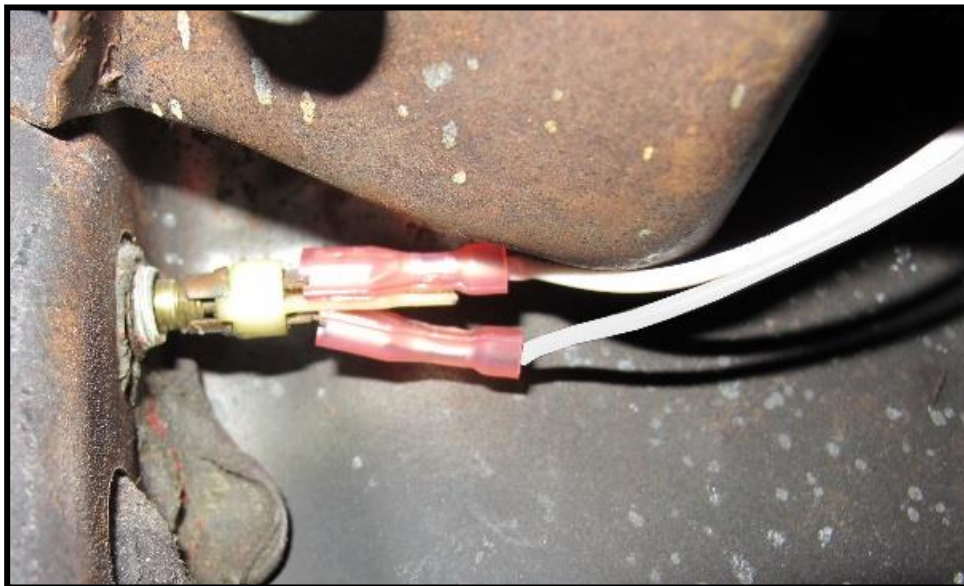

If this is a new build/restoration or your original switches are just in bad shape and new switches are needed, Painless offers factory style GM jamb switches as part #80170. Please note that part #80170 for one switch, 1 switch is needed for each door.

- If this switch, or this style switch, is used the insulated terminals found on both #961 driver will need to be removed from the harness and both #961 wires will need to be installed in to a single blue insulated “bullet” style terminal from the parts kit, as seen in the photo on the next page.

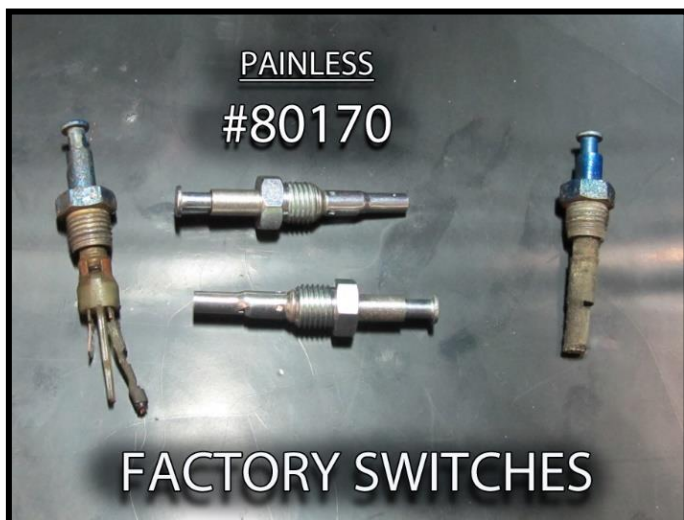

Driver Courtesy Light

This connection will allow the under dash/pedals of the driver side of the vehicle to be illuminated any time a door is open or when the headlight switch is activating the dome light. Your vehicle may or may not have had them from the factory; that will not affect these working properly as they have been pre-wired into the Painless harness.

This connection will have a section label reading "COURTESY LIGHT". It will be a large gray colored lamps socket with four wires pre-wired to it, These wires can be seen in the [Courtesy/Dome Light Schematic](#) on the next page, these wire are:



- (2) **Orange:** 18 gauge, printed **#971 COURTESY LIGHT POWER**. One wire provides power from the 10 amp DOME fuse on the fuse block; this fuse has battery power and has power at all times. The other wire, printed **#971 DOME LIGHT POWER**, provides power to the dome light through the tail harness connectors.
- (2) **White:** 18 gauge, printed **#961 COURTESY LIGHT GROUND**. This wire is the ground wire that activates the courtesy light. When this wire is grounded it completes the voltage path causing the light to illuminate. This ground will come from either the door jamb switch or the headlight switch depending on if the door is opened or the headlight switch is turned to the "DOME LIGHT ON" position.

This light socket uses both a 63 and 67 series bulb; a 67 series bulb has been supplied in the parts kit.

- Route the socket to a suitable mounting location under the dash. The light socket has a small hole in a mounting tab to allow mounting. Self-tapping screws have been provided as a mounting solution. Small zip ties, provide with this kit, may also come in handy if a suitable location for the light socket cannot accommodate mounting with a screw.

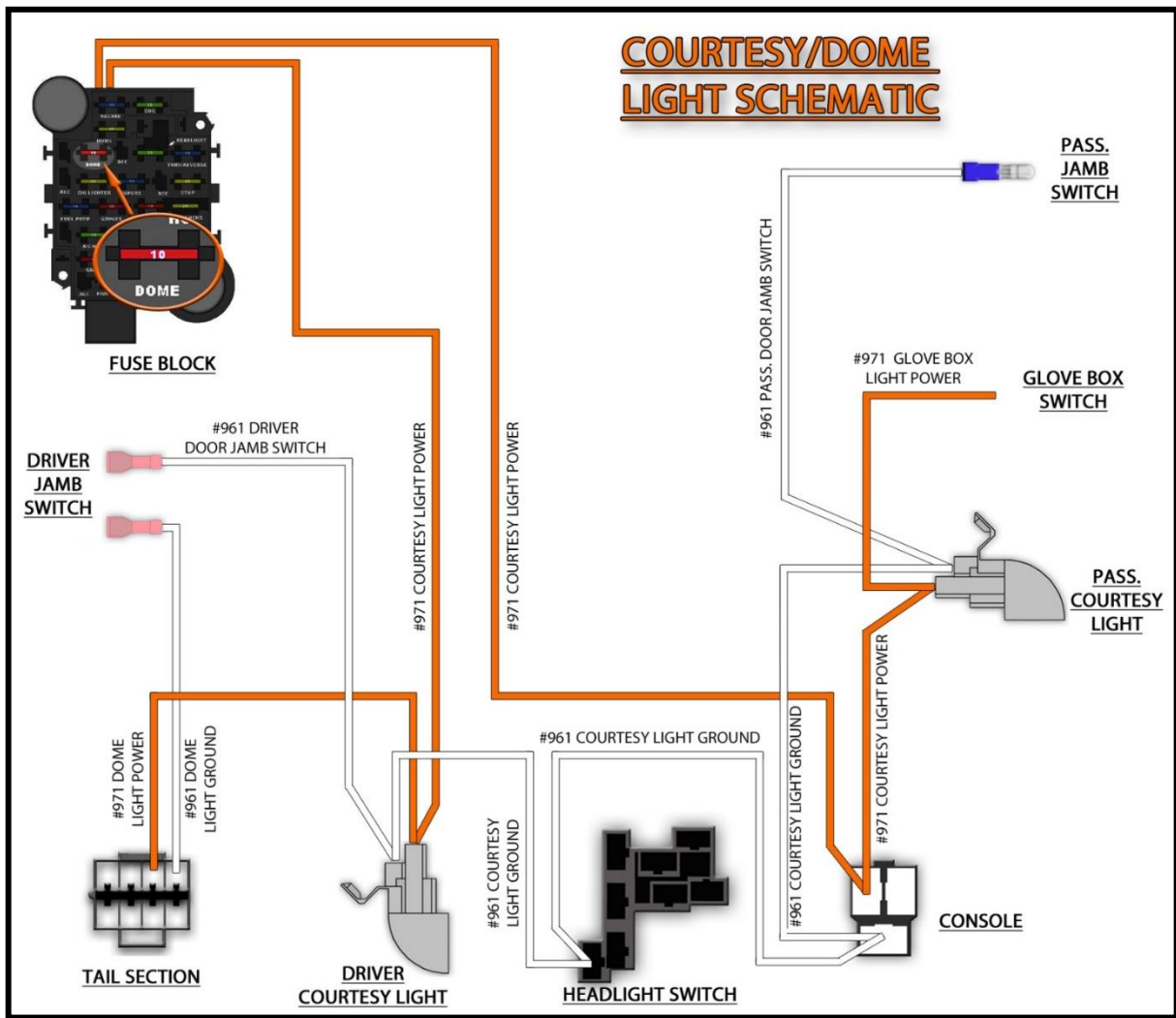

Other connectors in the driver kick panel area/left of the steering column are Headlight switch, Wiper Switch, and Wiper Switch Ground. These connections will take place as the gauge cluster is re-installed into the dash and will be skipped at this time.

“Brake Switch”

Locate the brake switch at the top of the brake pedal. This will be a small cylindrical switch that has a plunger, like the door switch, that opens and closes the switch based on brake pedal position.



This switch is what is called normally open, meaning the two terminals are not connected together when the switch is in its normal position. As soon as the brake is applied, it closes the switch to internally connect the two posts of the switch.

This switch requires two wires, a battery power wire and an output wire to the brake lights. The pre-installed connector, shown on the previous page, will connect to the factory switch. If your switch differs from the connector provided, the connector can be cut off the harness and insulated terminals from the parts kit, like those shown to the right, can be used to make individual wire connections to the brake switch.

The two wires of the Painless kit that make up the brake switch connection can be seen in the [Tail Harness Schematic](#) on [page 106](#), these wires are:

Orange: 16 gauge wire, printed **#917 BRAKE SWITCH POWER INPUT**, which provides power from the 15 amp STOP fuse. This wire will have power at all times.

White: 16 gauge wire, printed **#918 BRAKE SWITCH OUTPUT**, this wire supplies power from the brake switch to the turn signal switch for brake light operation. This wire goes to the turn signal because these vehicles have integrated brake/turn signals. Meaning, the turn signal and brake light share a filament in the bulb. This wire will have power anytime the brake pedal is pressed.

This splice can also be seen in the [Turn Signal Schematic](#) on page ??.

- Route the brake switch wires to the brake switch and connect using the pre-installed connector or loose piece insulated terminals provided in the parts kit. Be sure to route the wires away from the moving parts of the brake pedal and/or clutch pedal.

If your car has an aftermarket brake switch with four connection pins, two pins will have contact or will be closed when the brakes are not applied and two will be separate or open when the brakes are not applied. You will need the 2 posts that are separate or normally open. The normally closed pins are for cars equipped with cruise control or an automatic transmission with a lockup torque convertor, this harness does not provide wires for these features

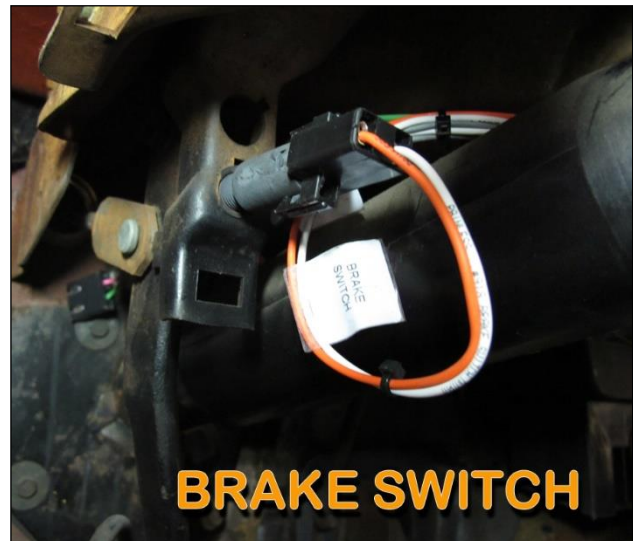

“Turn Signal Switch”

The column mounted turn signal switch will provide power to each turn signal indicator. The turn signal switch connection will exit the bottom of the steering column.

The wires provided in the Painless harness for turn signal connection can be identified by the section label reading “TURN SWITCH”. These will be ten pre-terminated wires with a white connector pre-installed that will accept one of the mating turn signal pigtailed provided with this kit. These wires can be seen in the [Turn Signal Schematic](#) on the [page 65](#), they are:

Black: 18 gauge wire, printed **#963 HORN RELAY GROUND ACTIVATION**, this wire is a ground activation signal to the horn relay. The only time this wire will be grounded is when the horn button on the steering wheel makes contact to a ground source.

Light Blue: 16 gauge wire, printed **#926 FRONT LEFT TURN SIGNAL POWER**, this wire will provide power to the left turn signal indicator on the gauge cluster as well as power to the front left turn signal. This wire will have power anytime the hazard switch is activated and also when the turn signal lever is in the down/left turn position and the ignition switch is in the ON/RUN position.

Blue: 16 gauge wire, printed **#925 FRONT RIGHT TURN SIGNAL POWER**, this wire will provide power to the right turn signal indicator on the gauge cluster as well as power to the front right turn signal. This wire will have power anytime the hazard switch is activated and also when the turn signal lever is in the up/right turn position and the ignition switch is in the ON/RUN position.

Brown: 16 gauge wire, printed **#951 HAZARD SWITCH POWER**, this wire provides power to the column mounted hazard switch. It comes from the hazard flasher found on the fuse block. It is a battery power wire but it will have power only when the hazard switch is activated, which causes the flasher to send power through this wire. See [Flashers](#) on [page 16](#) for how this process works.

Purple: 16 gauge wire, printed **#952 TURN SIGNAL SWITCH POWER**, this wire provides power to the turn signal switch. It comes from the turn signal flasher found on the fuse block. It is an ignition power wire but it will have power only when the turn signal switch is activated, which causes the flasher to send power through this wire. See [Flashers](#) on [page 16](#) for how this process works.

Yellow: 16 gauge wire, printed **#949 REAR LEFT TURN SIGNAL POWER**, this wire provides power to the left rear turn signal. This wire will have power anytime the hazard switch is activated and also when the turn signal lever is in the down/left turn position and the ignition switch is in the ON/RUN position. This wire also handles the brake light power and will also have power anytime the brake pedal is pressed.

Green: 16 gauge wire, printed **#948 REAR RIGHT TURN SIGNAL POWER**, this wire provides power to the right rear turn signal. This wire will have power anytime the hazard switch is activated and also when the turn signal lever is in the up/right turn position and the ignition switch is in the ON/RUN position. This wire also handles the brake light power and will also have power anytime the brake pedal is pressed.

White: 16 gauge wire, printed **#918 BRAKE SWITCH OUTPUT**, this wire will feed the brake light power into the turn signal switch. These vehicles have integrated brake/turn signals. Meaning, the turn signal and brake light share a filament in the bulb. This wire will have power anytime the brake pedal is pressed.

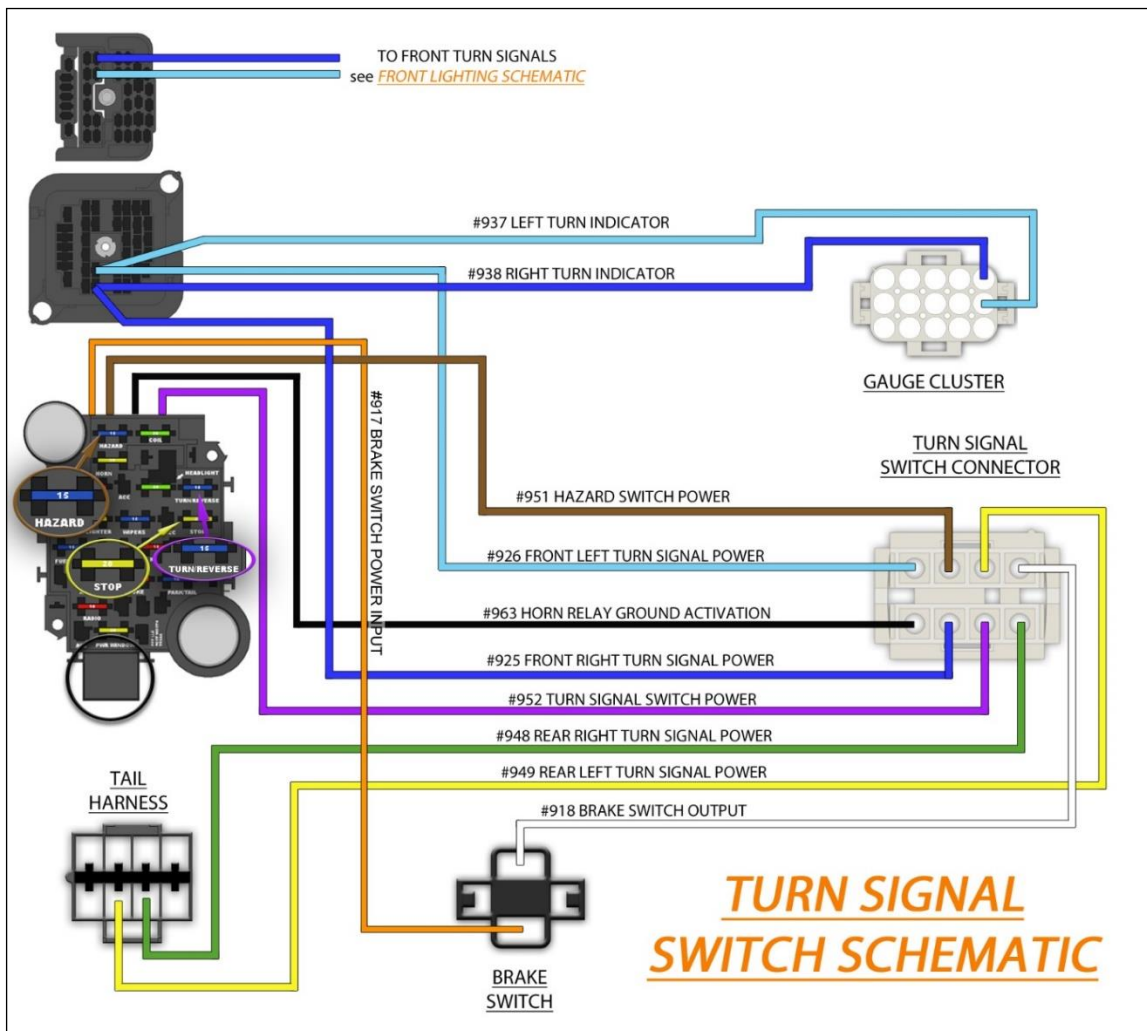

- Locate the two turn signal pigtails included with this kit. Both pigtails will have a white mating connector to the Painless harness on one end, and only terminals on the other end.
- Those with a factory 1968 column will need to reuse the factory “semi-circle” turn signal connector from the harness removed from the vehicle. This is done by using a small flat screw driver or stiff piece of wire and flattening the locking tangs on both sides of the terminal to remove them from the connector, as shown in the photo.

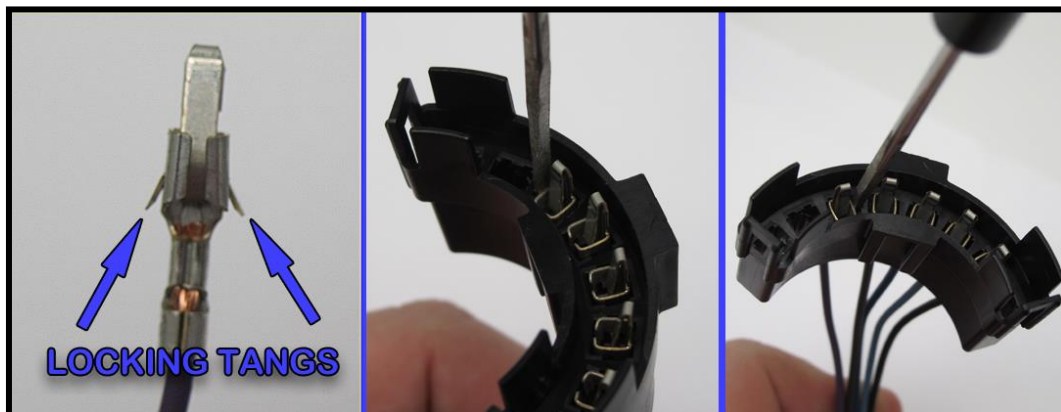

- Use the pigtail with the terminals shown on the previous page. Pin the factory connector you are reusing onto this pigtail using the diagram below. Once the connector is in place, plug the pigtail into the Painless harness and then the “semi-circle” factory connector onto the wire exiting the steering column.

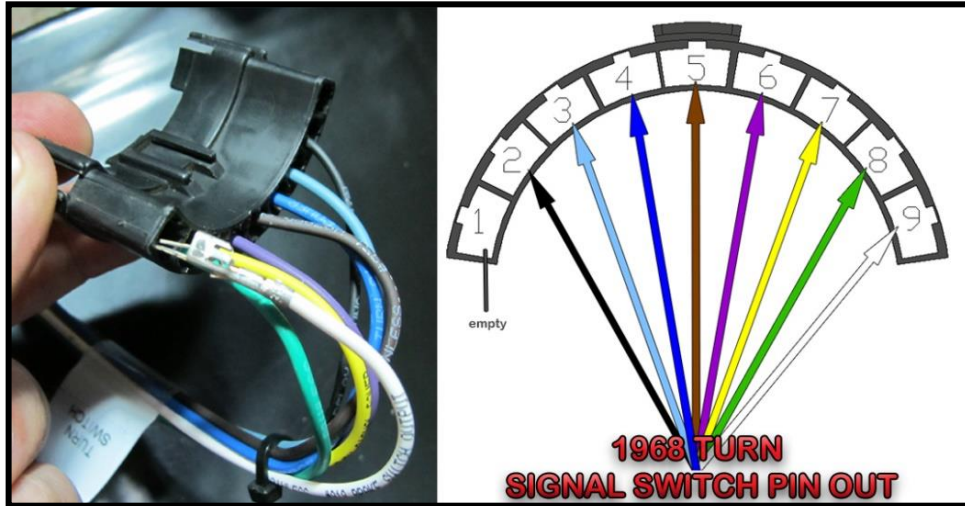

Those using a 1969-1972 model column or an aftermarket column with a later model turn signal switch will use the pigtail with terminals but no connector pre-installed. Mates to both types of the above mentioned turn signal connectors have been provided with your new Painless harness, seen in the diagram below.

- Locate the pigtail without a connector pre-installed on one end.
- In the bag kit there are 2 big black turn signal connectors, these connectors fit 1969-1972 Chevelle columns, as well as, aftermarket columns made by companies like Ididit and Flaming River which have a later model GM turn signal switch. Choose the connector that fits the column in your car. The earlier production turn signal switches, like those found on 1969-1972 factory Chevelle columns, will require the smooth connector.
- One by one, plug the wires of the “TURN SWITCH” group of wires on the “1969-1972”/ AFT. MARKET” pigtail into the connector according to the drawing below, letters identifying pin locations are molded into the connector as well.

The terminals will only insert into the connector ONE WAY, as shown below. **Make certain you are inserting the wire into the CORRECT LOCATION as the terminals are very difficult to remove once inserted.**

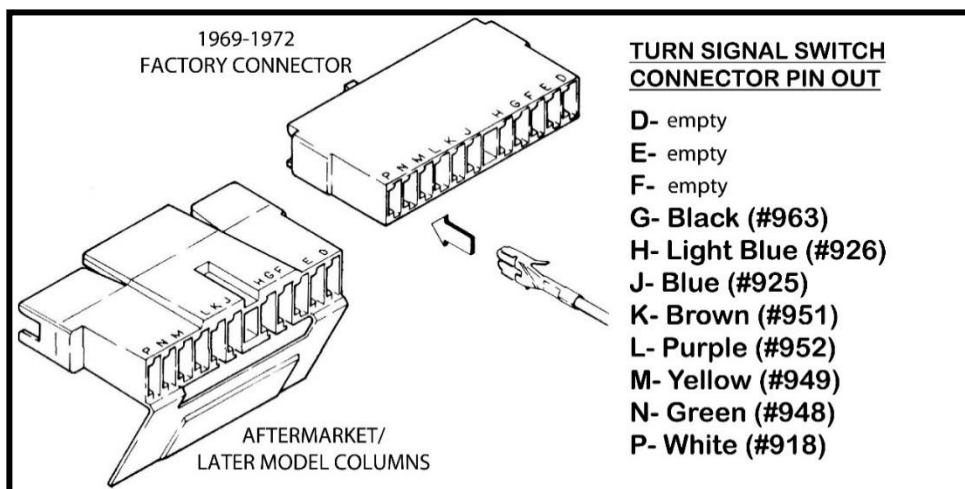

“Neutral Safety/ Clutch switch”

This switch is a 2 pin, normally open, switch that has power coming into one side from the start position of the ignition switch and power going out the other side to the starter solenoid “S” terminal.

This switch is a safety device that will prevent the vehicle from being started while in gear and causing an unfortunate accident. The purpose of this switch is to only allow the engine to be started when the vehicle is in park or neutral (automatic transmissions) or if the clutch is applied (manual transmissions). When the transmission is put into park/neutral or the clutch is applied, contact is made between these two pins, closing the switch. This allows power to flow from one pin to another, transferring power through the switch to the starter solenoid.

The neutral safety/clutch switch connection will have a section label reading “NEUTRAL SAFETY”. This will be a black 2 pin connector with 2 wires going to it, as seen on the previous page. These wires are:

Purple/White: 14 gauge wire, printed **#919 START SIGNAL (FROM IGN.SW. TO N.SAFETY)**, this wire comes from the Ignition switch. This wire is a switched ignition power wire. It will only have power when the ignition switch is in the START position. This wire can be seen in the [Starter Schematic](#) on [page 53](#), and on the [Ignition Switch Schematic](#) on [page 101](#) of this manual.

Purple: 14 gauge wire, printed, **#919 START SIGNAL TO STARTER**, this wire provides power from the neutral safety to the Starter solenoid. This wire will have power when the ignition switch is in the START position AND the transmission is in park or neutral (automatic) or the clutch is applied (manual). This wire can be seen in the [Starter Schematic](#) on [page 53](#).

- If you have an automatic transmission with a column shift, the neutral safety switch, or NSS, will be located at the base of the steering column. If you have a manual, the clutch switch will be located at the top of the clutch pedal much like the brake switch on the brake pedal. See the photos on below.

Plug the neutral safety connector onto the two pins of the neutral safety/clutch switch. If you have a floor shifter, leave this connection loose as connection to this connector will take place on [page 69](#).

If you are have a factory or aftermarket automatic floor shifter or automatic/manual transmission mounted NSS, connection to your NSS will be made later in the manual on [page 72](#) and this neutral safety switch connection will connect to the included console harness as described later in the manual on [page 69](#).

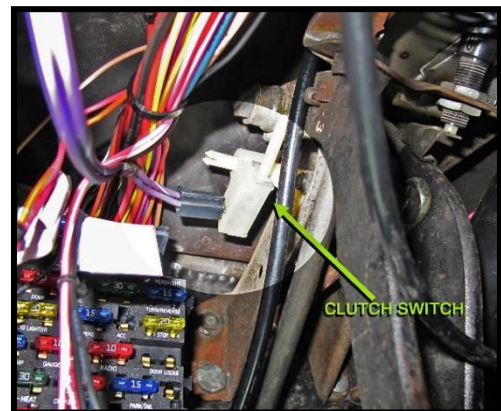
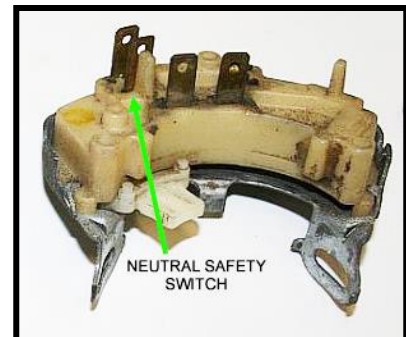

- If you do not have a neutral safety/clutch switch, and do not plan on getting one, cut the connector from these two wires and connect the **PURPLE #919** and the **PURPLE/WHITE #919** together. If this is not done, your car will NOT start.

Painless does not recommend operating your vehicle without a neutral safety/clutch switch.

“Reverse Switch”

The reverse switch, also referred to as the backup switch, connection will provide the reverse lights the power they need to illuminate. This switch is a 2 pin normally open switch that has power coming into one side and power going out the other side to the reverse lights. When the shifter is put into the reverse position, contact is made between these two pins, closing the switch. This allows power to flow from one pin to the other, transferring power through the switch out to the backup lamps.

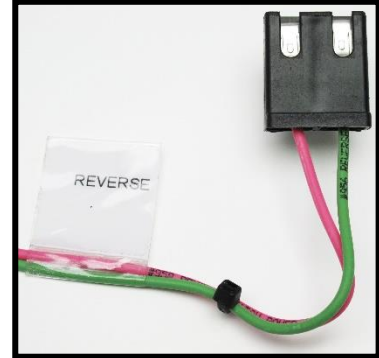

The reverse switch connection will have a section label reading “REVERSE”. This will be a black two pin connector with two wires going to it, as seen above. These wires can be seen in the [Tail Harness Schematic](#) on [page 106](#), these wires are:

Pink: 16 gauge wire, printed **#958 REVERSE SWITCH POWER INPUT**, this wire comes from the 15 amp TURN/REVERSE fuse on the fuse block. This wire is a switched ignition power wire meaning it will only have power when the ignition switch is in the ON/RUN position.

Light Green: 16 gauge wire, printed **#956 REVERSE LIGHT POWER**, this wire provides power from the reverse switch to the backup lights in the Tail Section of the Painless harness.

- If you have an automatic transmission with a column shift, the reverse switch will be located at the base of the steering column, as seen in the photos below. Plug the reverse switch connector onto the 2 pins of the reverse switch.
- If you are have a factory or aftermarket automatic floor shifter or automatic/manual transmission mounted reverse switch, connection to your switch will be made later in the manual on [page 72](#) and this reverse switch connection will connect to the included console harness as described on the next page.

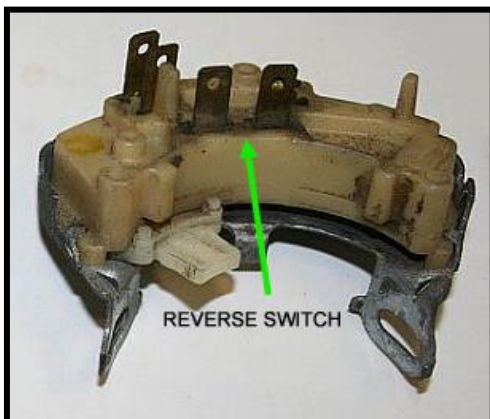

“Console”

If your NSS and reverse lights were connected on the steering column and you have no need for any console connections, this connector can be skipped, simply zip tie it to the harness and move on to the next step on [page 74](#), “Ground”.

A connection, as well as a separate sub harness, has been furnished in the Painless harness kit for connection to a center console. Connections provided on the console harness include a neutral safety switch, reverse switch, gear indicator lighting, and a courtesy light. All of these components could be found in a factory console. Those using an aftermarket automatic floor shifter can use this sub harness to make connections to the shifter mounted neutral safety switch, reverse switch, and gear indicator light.

The console connection on the Painless chassis harness will consist of three wires, they are:

- (2) **Orange:** 18 gauge, printed **#971 COURTESY LIGHT POWER**. One wire provides power from the 10 amp DOME fuse on the fuse block; this fuse has battery power and is hot at all times. The other wire provides power to the passenger side courtesy light, as seen in the [Courtesy/Dome Light Schematic](#) on [page 62](#). These wires provide power to the courtesy light found on the back of factory consoles.
 - (2) **White:** 18 gauge, printed **#961 COURTESY LIGHT GROUND**. These wires are the ground wires that activate the courtesy light. When these wires are grounded it completes the voltage path causing the light to illuminate. This ground will come from either the door jamb switch or the headlight switch depending on if the door is opened or the headlight switch is turned to the “DOME LIGHT ON” position. These wires can be seen in the [Courtesy/Dome Light Schematic](#) on [page 62](#). These wires provide a ground activation to the courtesy light found on the back of factory consoles.
 - (2) **Gray:** 18 gauge wire, printed **#930 PANEL LIGHT POWER**, this wire goes into a splice from the headlight switch that supplies power to all the gauge and panel back lighting. This wire, as well as the mentioned splice, can be seen in the [Headlight Switch Schematic](#) on [page 96](#). The other gray wire in this connector is printed **#930 RADIO BACKLIGHT/DIM POWER**, this wire will provide a power source to the radio for either backlighting, like found on older radios, or to control the dimming feature found on modern head units.
- Begin by locating the supplied console sub harness. This will be a large bundle of wire labeled “CONSOLE HARNESS”.
 - With the console removed from the car, starting at where the shifter is located on the transmission tunnel, route the harness under the carpet, towards the fire wall, as seen in the photo on the next page. The portion of the console harness that needs to be routed forward is the end of the harness with three connectors labeled, “TO CONSOLE CONN”, “TO NSS”, and “TO REVERSE”.
 - Connect these three connectors to the NSS, Reverse Switch, and Console connectors found on the Painless chassis harness.

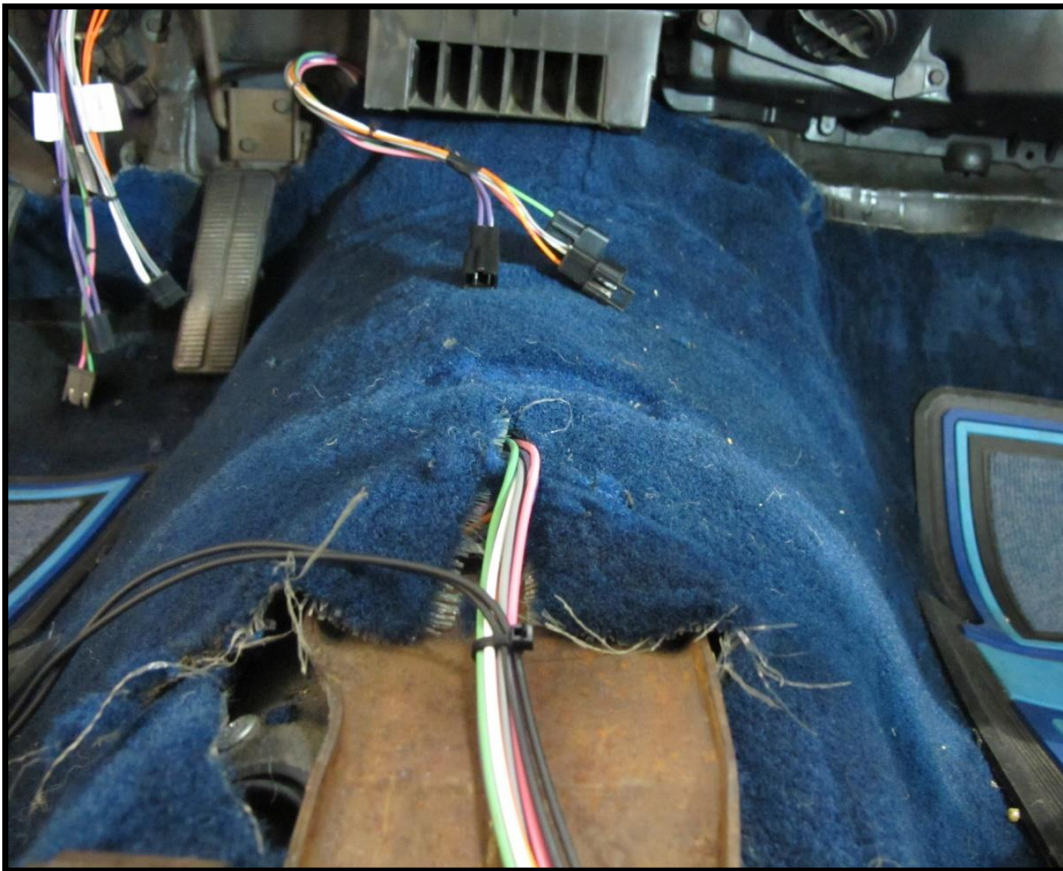

Connections found on the console sub harness will be determined by the transmission, shifter, and switches being used in your particular application. You may find that length will need to be added to the NSS and reverse switch wires if you have transmission mounted switches.

Before installation of the factory console can take place, the Courtesy light found in the back of the console will need to have the small Courtesy light pigtail found on the sub harness installed. This pigtail will allow easier removal of the console if it ever needs to be removed.

- Remove the factory terminals/bulb contacts from the rear courtesy light lens. The sub harness has new terminal/bulb contacts. This is done by using a pair of pliers, and squeezing the base of the contact and pushing it down through the openings in the mounting flange on the lens. If this is an original lens, use caution as the plastic will be brittle because of age and the countless heat cycles generated by the bulb.

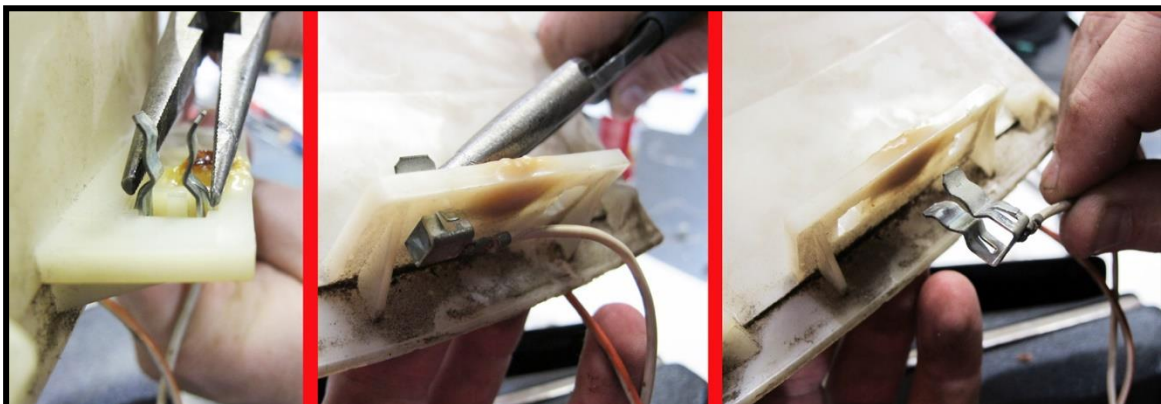

- Unplug the courtesy light pigtail from the Painless console sub harness, shown below. Insert the terminals into the flange on the lens and install a bulb, not supplied. This bulb can be found at your local auto parts store using part #212-2, this will be for a 6 candle power bulb. Do not use a higher powered bulb, like the one used in the overhead dome light, as they get too hot and will melt the plastic lens as evident on the lens on the previous page and below from our install car in which a previous owner had installed the wrong bulb.

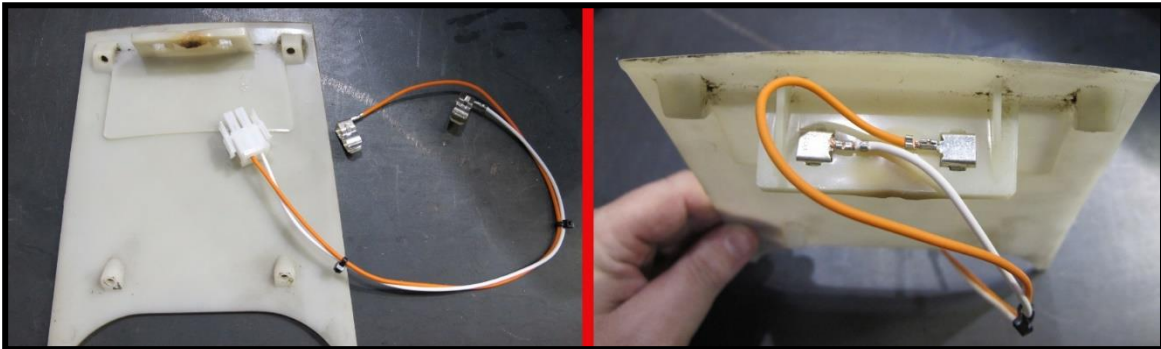

- Install the lens back on to the console and set the console into place on the transmission tunnel. **Do not bolt the console down at this time**, it should be simply placed in its location. The pigtail will need to exit the side of the console and will be connected and stashed under the console in the next step.
- At the front of the console, route the sub harness over any portions of the console that will interfere with the console lying flat and route the sub harness towards the rear of the console. Insert the white 2 pin connector that plugs into the courtesy light pigtail, into the pass through hole, as seen below.
- With the mating connector now under the console compartment, connect it to the courtesy light pigtail and push the connectors under the console compartment out of sight.



- Locate the two black wires at the front of the console, these wires will provide ground to the gear indicator sockets, if you are using a manual transmission, this connection can be skipped.
- Using one of the mounting bolts of the console, connect this ground connection to a clean chassis ground source.



- For factory automatic shifters, connect the NSS and reverse switch found on the base of the shifter. Use zip ties to help keep the wires out of the shifter gates and away from moving parts.

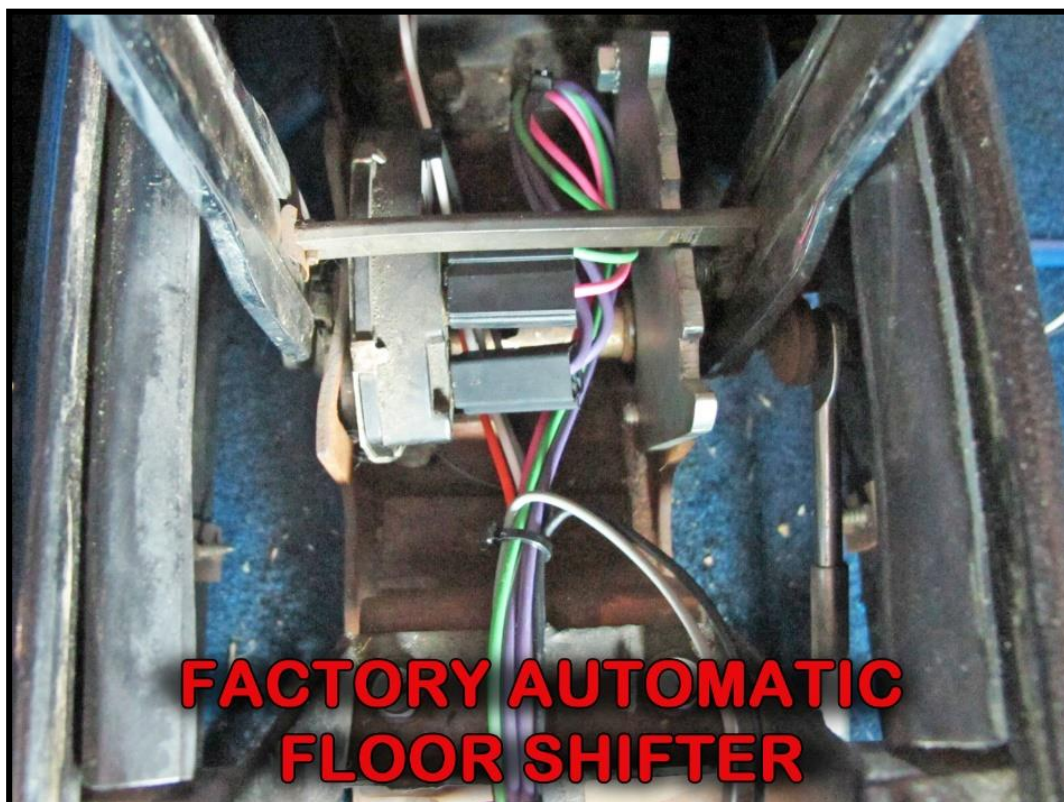

- For aftermarket automatic shifters, in many cases, NSS and Reverse switches can be found at the base of the shifter. These will normally be small micro switches. Remove the connectors found on the console sub harness, and install insulated terminals from the parts kit that fit the tabs coming from the aftermarket switches, as shown in the photo to the right.

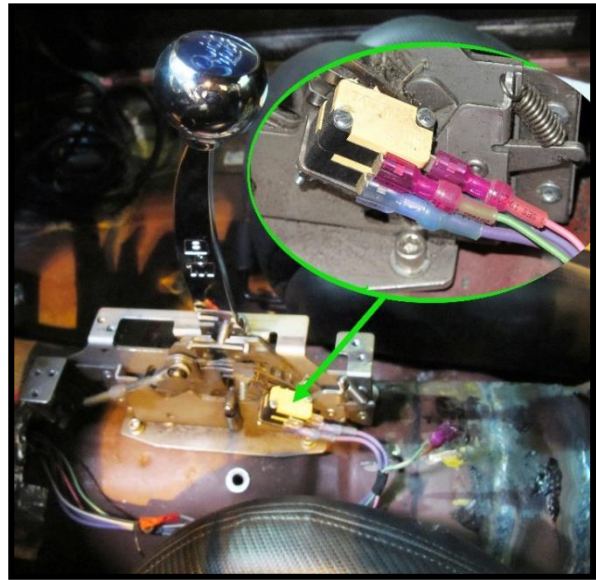

- For manual transmissions or later model automatic transmissions such as 700r4, 4L60E, 4L80E, etc., if your connections are on the transmission, the two connectors found on the console sub harness will need to be removed. Additional length may need to be added to the NSS and reverse switch wires in order for them to reach the connections found on your transmission. Connect the wires for NSS function and reverse switch operation to the transmission mounted switches.
- At this time, all the mounting bolts for the console can be re-installed the console can be secured into place. For manual transmissions, the gear indicator bulbs will not be used, tape or zip tie these sockets to the harness. Make sure the gray wire has zero chance of shorting to a ground source as this wire will have power any time the panel lights are on.
- Those with automatic transmission shifters, install a bulb from the parts kit into one or both sockets, depending on how many bulbs your indicator lens requires. If you only require one bulb, as most aftermarket shifter require, tape or zip tie the extra socket to the harness. Make sure the gray wire has zero chance of shorting to a ground source as this wire will have power any time the panel lights are on.
- Once the gear indicator sockets have been installed, secure the gear indicator lens, all of the console connections have now been completed.

This concludes all of the connections found on the console sub harness, this manual will now continue on to the “Ground” connection found on the chassis harness.

“Ground”

The interior ground wire is the next connection you will come to. It will help provide a clean ground source to interior components such as the gauge cluster, radio, wiper switch, headlight switch, etc. This connection will also supply another good ground source to the integrated ground circuit that has been incorporated into this Painless kit.

This ground wire will have a section label reading “Ground” and will have a ring terminal pre-installed. The wires going to this ring terminal will be:

(2) Black: 12 gauge wires, both printed **#969 GROUND**. These wires provide the ground source for the **#969** circuit as it is spliced into the ground circuit. This ground wire, along with all the other wires it is spliced to can be seen in the [Ground Schematic](#) on [page 15](#).

- Locate a small ½” self-tapping screw and star washer from the parts kit and locate the ground wire on the Painless harness.
- Route this ground wire to a clean ground source and clean the connection point by sanding away any paint that may interfere with a clean solid contact to ground.

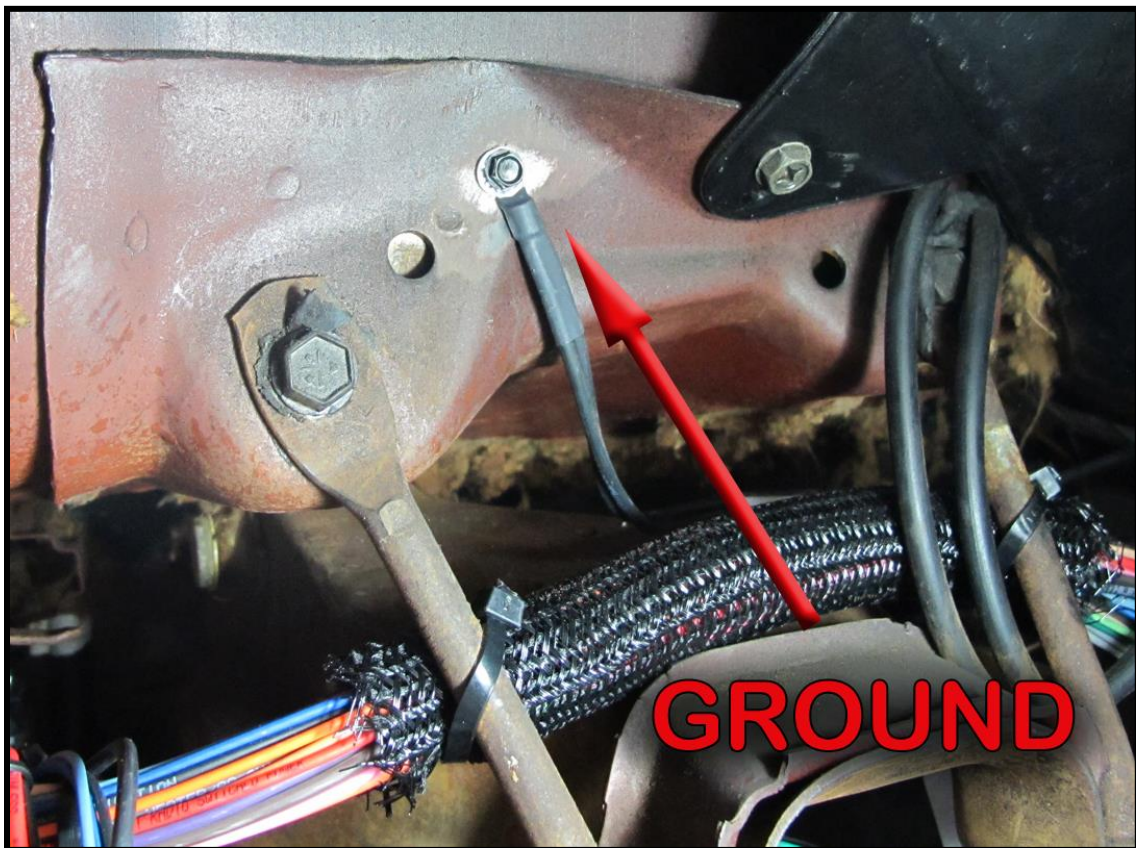

Connection to the Ignition Switch, Lighter, and Gauge Cluster will come later in the manual when the dash panel is ready to be re-installed.

Aftermarket Gauges

An addition to the Painless harness, and not found on a factory harness, is a connection providing all the wires needed for aftermarket electric or mechanical gauges.

This connection is intended for those using aftermarket gauges mounted on the lower portion of the dash and for those running an aftermarket tachometer mounted on the steering column or elsewhere on the dash. If you have an aftermarket tach mounted in the actual gauge cluster, connection to this tach will take place on [page 90](#). If you are mounting gauges on the dash below the radio, on the console, steering column, etc, this connection will be useful to you as you do not have to cut and splice into any of the other gauge wires on your new Painless harness.

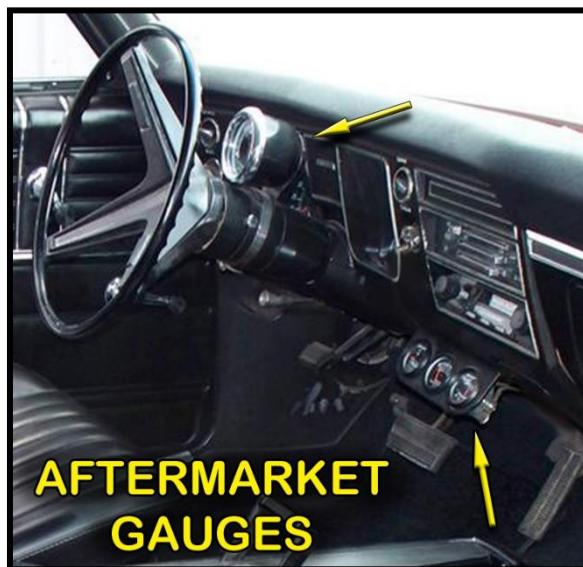

This connection on the Painless harness will consist of an eight pin white connector with seven wires and will have a section label reading "AFTERMARKET GAUGES". The wires in this connector can be seen in the [Gauge Cluster Schematic](#) on [page 94](#), they are:

Black: 16 gauge wire, printed **#969 GROUND**, this wire provides a ground source. This wire is tied into the integrated ground circuit and can be seen in the [Ground Schematic](#) on [page 15](#).

Gray: 18 gauge wire, printed **#930 AFTERMARKET GAUGE LIGHT POWER**, this wire will provide a power source for the gauge light(s). The gray #930 is tied to the other #930 wires coming from the headlight switch to things like the radio backlight/dim, panel lights, and gear indicator light. This wire will have power anytime the headlight switch is in the Park/Tail Lights ON or Headlights ON position. This wire can also be seen in the [Headlight Switch Schematic](#) on [page 96](#)

Pink: 18 gauge wire, printed **#935 GAUGE POWER**, this wire provides a switched ignition power source for any gauges. This wire comes from the 10 amp GAUGES fuse on the fuse block. This wire will have power anytime the key is in the ON/RUN position.

Tan: 18 gauge wire, printed **#939 FUEL LEVEL SIGNAL**, this wire is a ground signal from a fuel level sending unit in the fuel tank. The resistance to ground will vary on this wire according to how much fuel is in the tank. This wire can also be seen in the [Tail Harness Ground Schematics](#) on [pages 106, 128, and 137](#).

Green: 18 gauge wire, printed **#921 COOLANT TEMPERATURE SIGNAL**, this wire is a ground signal from the engine coolant sending unit. The resistance to ground will vary on this wire according to engine temperature. This wire can also be seen in the [Ignition Switch Schematic](#) on [page 101](#).

Brown: 18 gauge wire, printed **#923 TACH SIGNAL**, this wire is a ground signal from the negative side of the ignition coil. This wire can also be seen in the coil/ignition connection diagrams on [pages 39-41](#).

Blue: 18 gauge wire, printed **#922 OIL PRESSURE SIGNAL**, this wire is a ground signal from the oil pressure sending unit. The resistance to ground will vary on this wire according to oil pressure.

A mating connector and terminals have been provided to allow connections to be made to gauges without having to hard wire the chassis harness directly to the gauges.

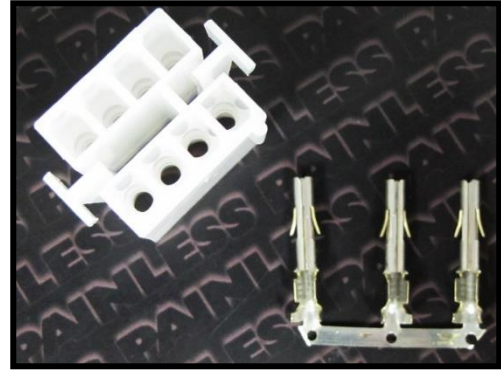

The next few pages outline routing gauge power/ground and backlighting power/ground from the mating connector to the gauge(s).

- The included terminals will require a ¼” strip length on the wire they are being applied to, and the use of roll over crimpers.
- Using the diagram pin out of the supplied connector, plug the wires going to your aftermarket gauges into their corresponding pin location. The terminals will be inserted into the square opening of the connector and the pin locations can be identified by the numbers printed above the round opening of the connector.

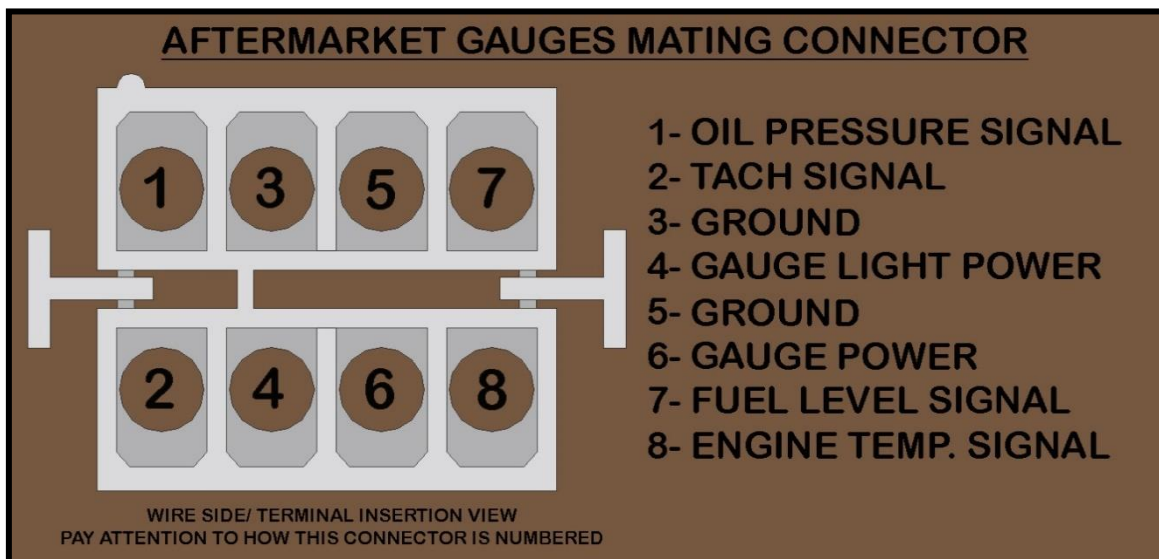

Wiring Aftermarket Gauges:

For those wiring aftermarket gauges, please be aware that wiring for actual connection to the gauges themselves is not provided with this harness. You can however use scrap wire cut off from previous connections of this chassis harness and insulated terminals from the parts kit. The following steps will walk you through the process of distributing power and ground, as well as connecting the sender wires. The following diagrams only show temp, oil pressure, volt and fuel level gauges. Power, ground and sender wires will connect in the same manner to tachometers.

Power to the gauges will need to come from the pink **#935 GAUGE POWER** on the connector, **pin 6** in the diagram above. Power will need to be connected to the “I” or “12v” post on the gauge or gauges. The power wire can be connected in one of two ways:

#1) **Splicing:** Splice off one wire from *pin 6* of the mating connector and running wires to several gauges.

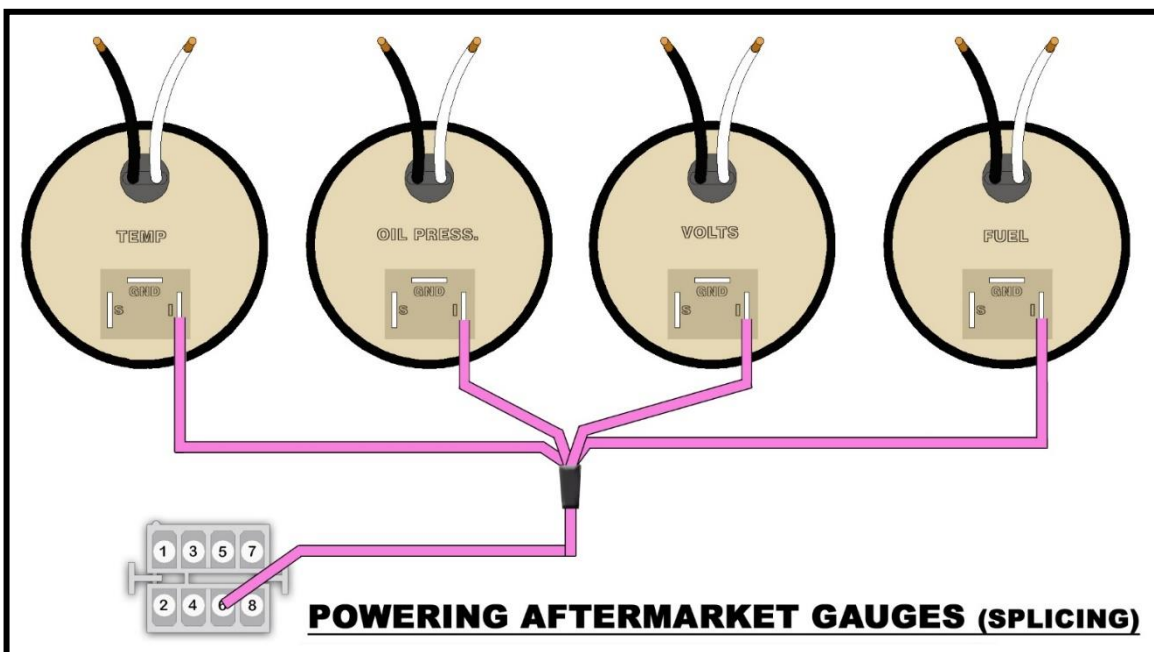

#2) **Chaining or Jumpering:** Run one wire from *pin 6* of the mating connector to a power post, before terminating the wire with the proper terminal, you will insert another wire into the terminal and crimp. You will now have 2 wires in one terminal. This additional wire will then route to the power post on another gauge. Before terminating the wire with the proper terminal, you will insert another wire into the terminal; and so on.

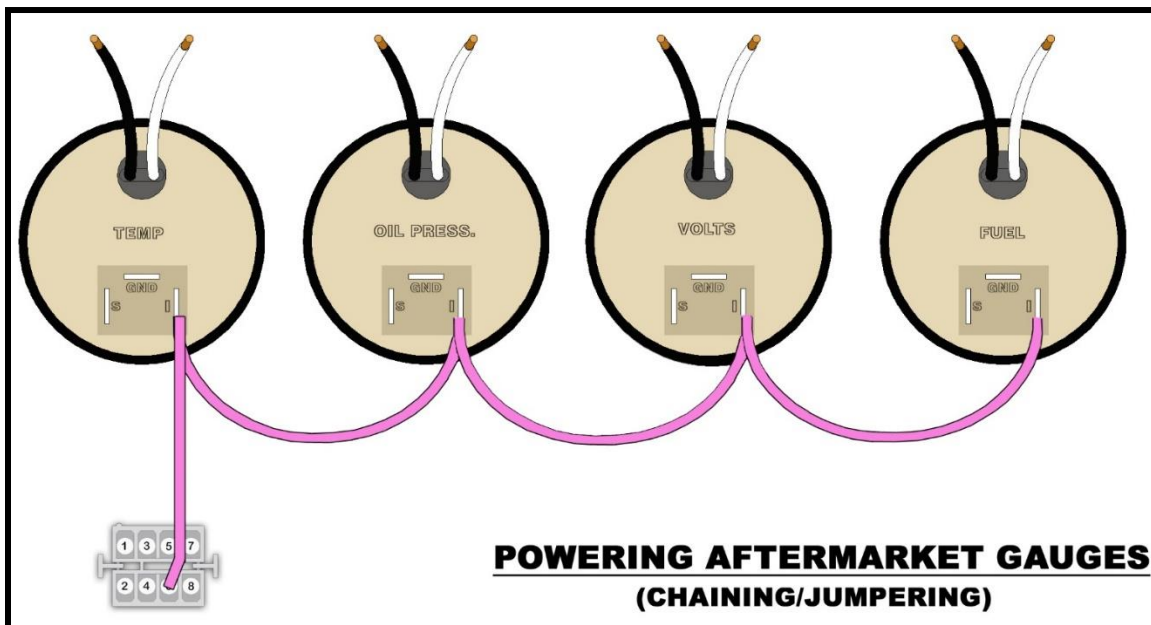

Grounds will need to be supplied to the gauge lights and to any ground tab on the gauges. These grounds can come from **pins 3 & 5** of the mating connector, and/or seeing that a good ground source is not hard to find on these vehicles, the installer could run their own ground circuit for gauge connections. To make these ground connections you can splice from a single wire to all the gauges or chain/jumper it all together. Both methods are shown in the following two drawings:

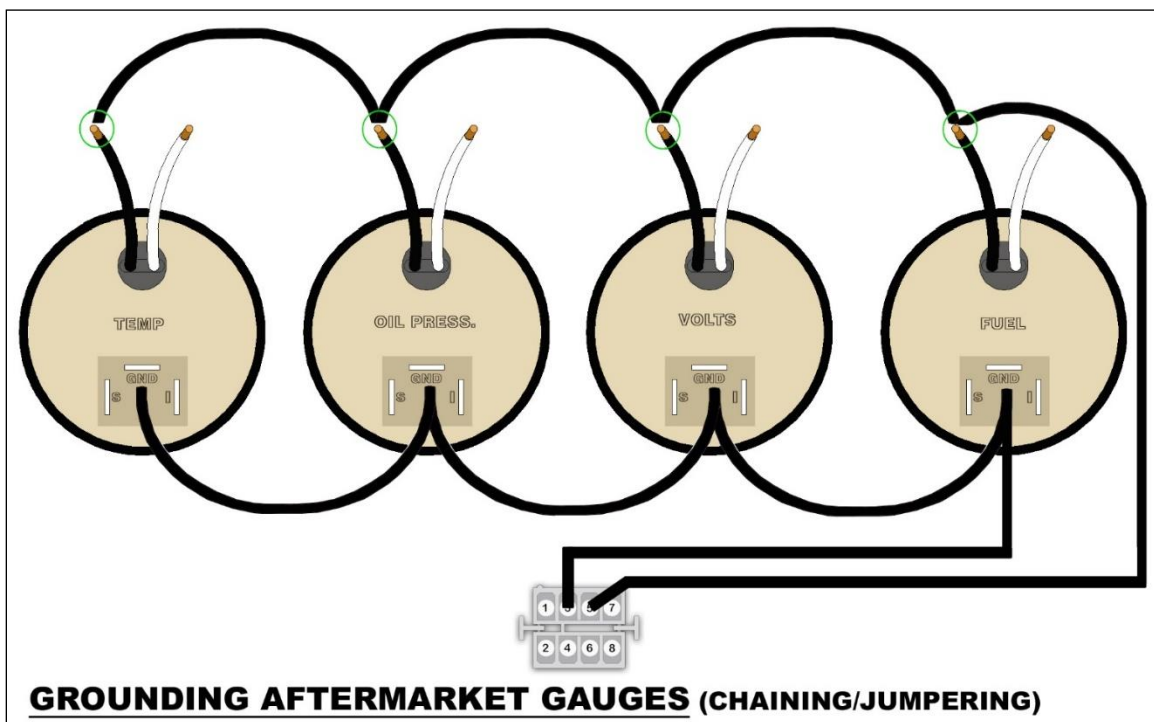
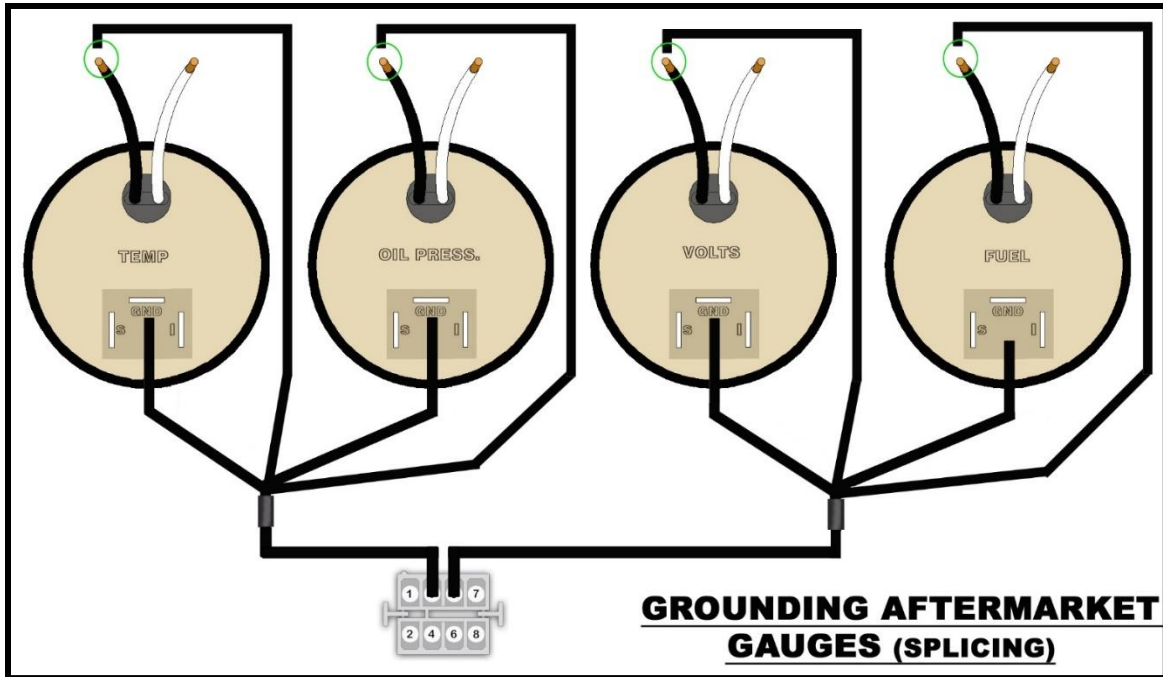

Gauge light power will be supported by **pin 4** of the mating connector. This wire will connect to one of the leads for the gauge light, or to the gauge light tab found on gauges with LED backlighting. To make these connections you can splice from **pin 4** to all the gauges or chain/jumper it all together. Both methods are shown in the following two drawings:

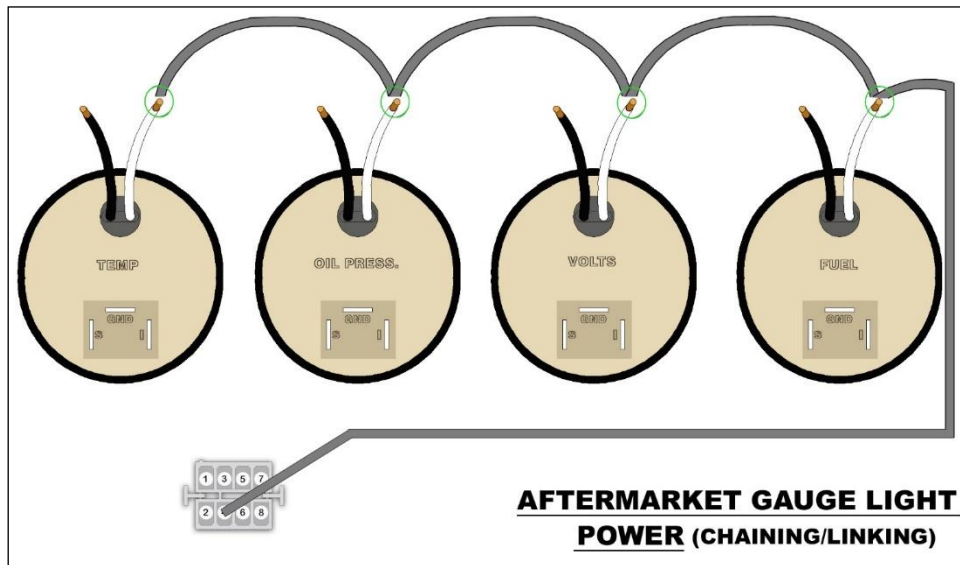
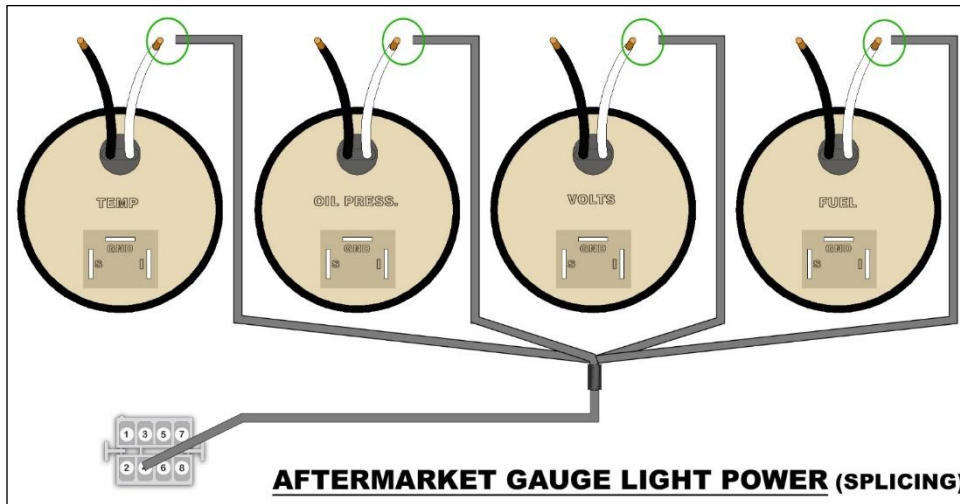

The last connection needing to be made will be the sending unit wires or signal wires. These will be the wires which come from the temperature sending unit, oil pressure sending unit, and fuel level sending unit. These signal wires will come from **pin 1** (oil press), **pin 2** (tachometer), **pin 7** (fuel level), and **pin 8** (engine coolant temp).

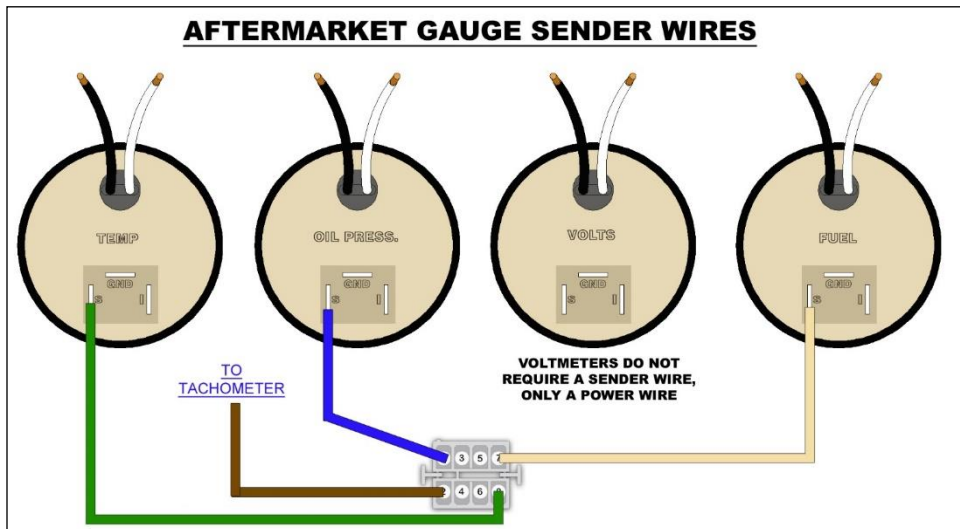

“Heater Switch”

The next connection is the power supply from the Painless harness to the blower switch. This connection will also be used for a power source if you are installing an aftermarket A/C system such as Vintage Air.

The heater switch wires have a section label reading “HEATER”. There will be two wires in this group with connector pre-installed. The wires can be seen in the [Accessory Schematic](#) on [page 103](#) and also in the [Heater Only Schematic](#) on [page 82](#), these wires are:



Brown: 14 gauge wire, printed **#904 HEATER SWITCH POWER INPUT**. This connection will be a 30 amp, ignition switch power source, from the A/C-HEAT fuse on the fuse block.

Orange: 12 gauge orange wire printed **#967 BLOWER MOTOR POWER**. This wire will have a single pin black connector pre-installed. This wire will provide power to the blower motor from the blower switch and will only be needed by those with factory heater only vehicles.

Installs using an aftermarket A/C, this brown **#904** wire will provide a switched ignition power source your system may need. A connector and flag style terminal, seen in the photo, have been provided to allow you to make a factory style connection to your aftermarket system.

- Install the terminal and connector shown onto the wire of your aftermarket A/C system harness that requires a fused switched ignition 12v source.
- The **#964 ORANGE** wire will not be needed with your application and may be removed from the harness. Once the power connection has been made to the wiring of your aftermarket AC unit, continue on to [page 84](#)



The two connections of the “HEATER” group of wires will be made to the inline connectors on the supplied blower switch harness or to the inline power connector on your factory A/C harness. **Those with factory A/C equipped vehicles will re-use your original harness.**

Those using factory A/C harness:

- As previously mentioned on [page 3](#), this harness does not include any wiring for the factory air conditioning; your original harness or a reproduction of the original harness must be used. The Painless harness will plug directly into a factory/reproduction harness without any modifications.
- Locate the inline connector on the factory A/C harness, it will be a single pin connector with a brown wire several inches away from the blower switch connection. Plug the brown **#904** power wire into this connector on the air conditioning harness.

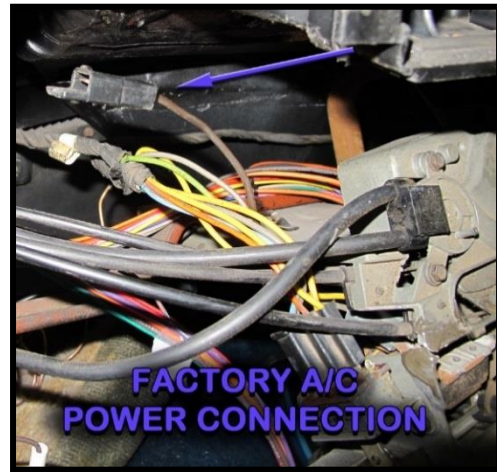

The **ORANGE** wire **#967** of the Painless harness will not be needed.

If you have a heater only system, locate the supplied blower switch sub harness, seen in the photo below, and remove it from the bag. **The supplied blower switch harness, will only work on vehicles that have heater only systems.**

Those using factory heater only systems:

- Locate the heater only sub harness provided with this kit. Connect the four pin connector, seen in the photo, labeled "BLOWER SWITCH" to the blower switch on the HVAC panel.
- Connect the **BROWN #904** and **ORANGE #967** wires on the Painless chassis harness to the two single pin connectors coming from the blower switch connector; brown will connect to brown and orange to orange as seen in the [Heater Only Schematic](#) on the next page.



- Connect the 4-pin connector found on the sub harness, seen below/left, to the blower switch.
- The remainder of the A/C harness or blower switch sub harness will route to the passenger side of the vehicle with the remainder of the chassis harness.
- Connect the 3 pin connector found on the sub harness, seen below/right, to the blower motor resistor.

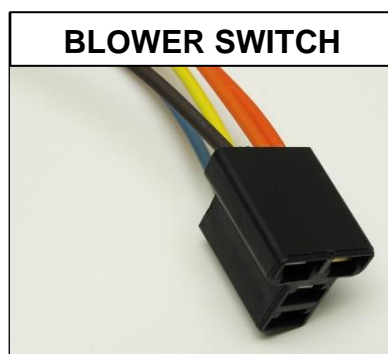

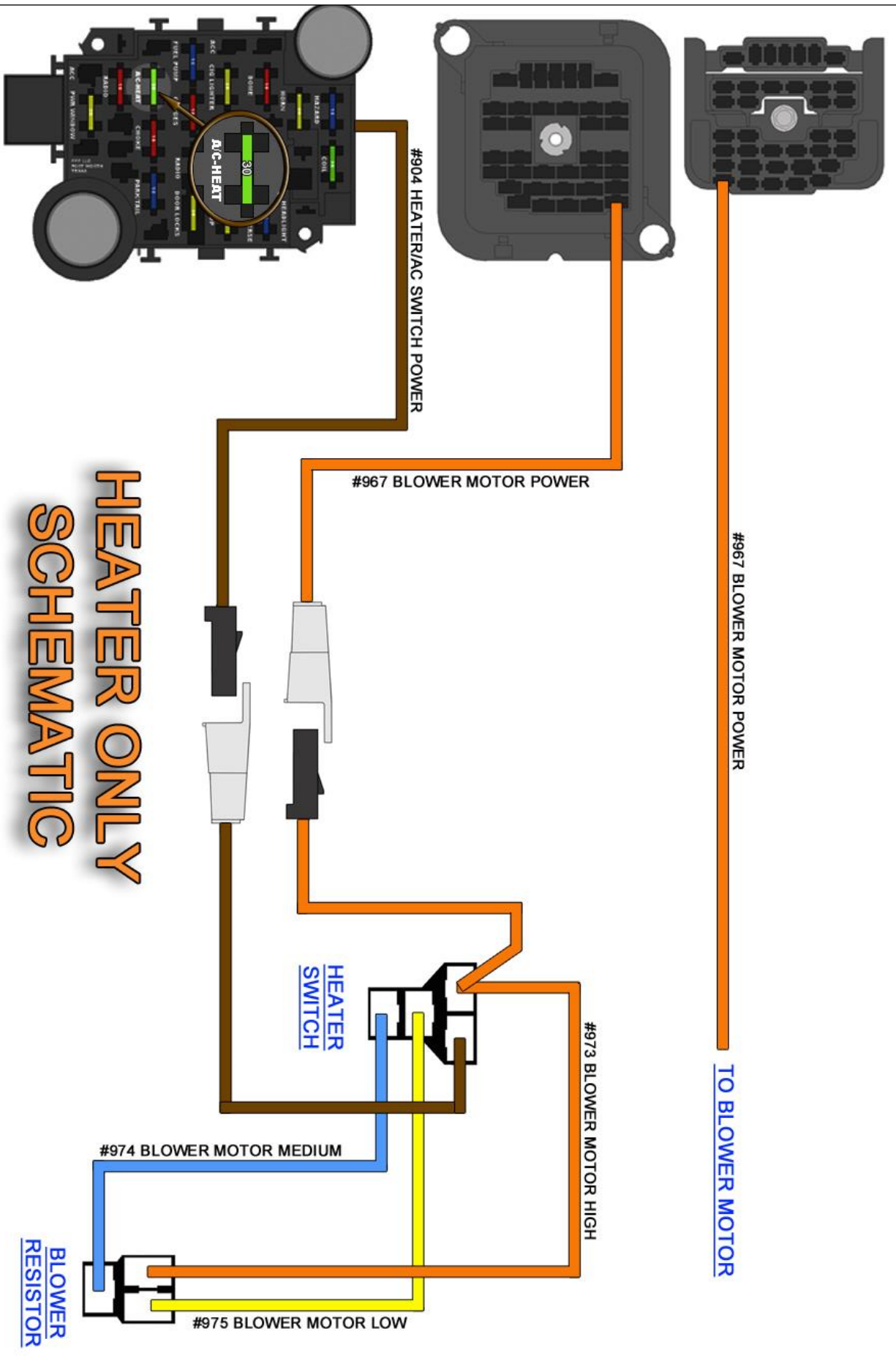

HEATER ONLY SCHEMATIC

“Heater Panel Light”

The next connection on the new Painless chassis harness is the panel light. This connection will provide a light source to the A/C or blower switch panel. This light socket receives power from the headlight switch whenever the headlight switch is in the Park Lights ON and in the Headlights ON positions.

The panel light connector has a section label reading “**HEATER PANEL LIGHT**,” as seen in the photo. This will be a two pin black socket pre-installed; the wires in the socket will be:

Gray: 18 gauge wire, printed **#930 PANEL LIGHT POWER**. This wire comes from a splice that distributes power from the headlight switch. This splice can be seen in the [Headlight Switch Schematic](#) on page 96.

Black: 18 gauge wire, this wire is not printed. This wire provides a ground source for the light and comes from a splice that is tied to the interior ground wire. This panel light ground and the other interior ground wires and splices, can be seen in the [Ground Schematic](#) on page 15.

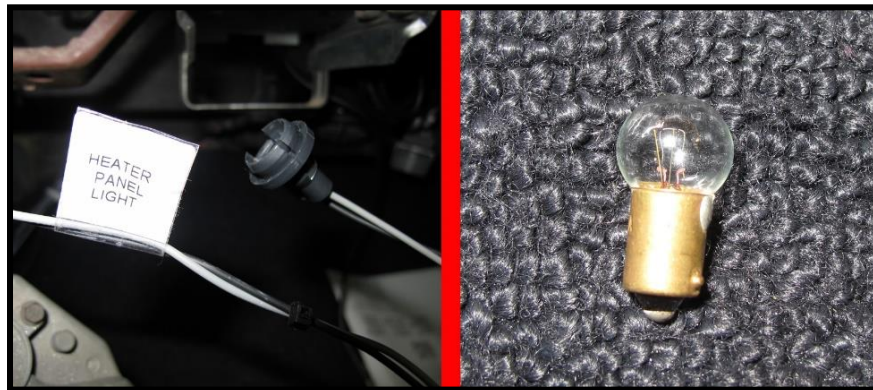

- Locate a small bulb from the parts kit and install it into the socket. A small dab of dielectric grease on the bulb base before installation will help with bulb removal later down the road if the bulb ever burns out.
- Insert the socket, with the bulb installed, into the panel lamp hole on the back of the A/C or blower switch panel.

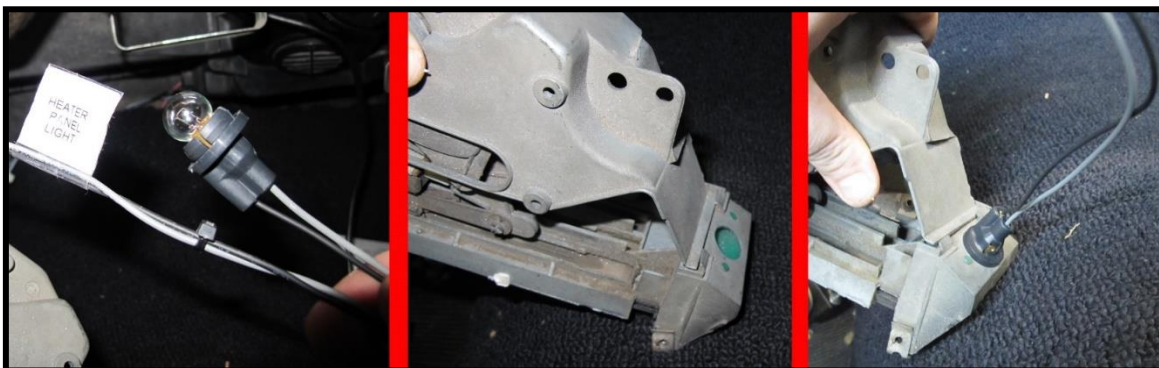

Passenger Side Routing

The two wires labeled “GLOVE BOX” and “PASS. DOOR JAMB SWITCH” will now need to be routed. Two factory installed clips will hold these wires in place, as seen in the photo below.

The “**GLOVE BOX**” wire will only need to route through the first clip, as shown.

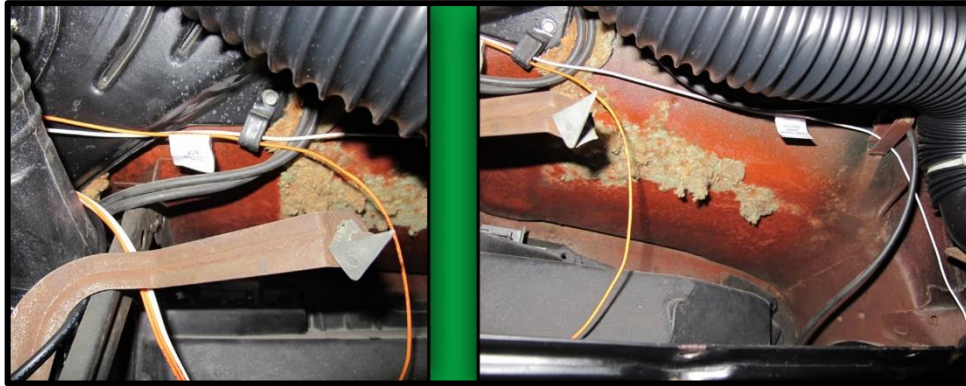

Passenger Courtesy Light

This connection will allow the under dash/floorboard of the passenger side of the vehicle to be illuminated any time a door is open or when the headlight switch is activating the dome light. Your vehicle may or may not have had them from the factory; that will not affect these working properly as they have been pre-wired into the Painless harness.

This connection will have a section label reading “COURTESY LIGHT”. It will be a large gray colored lamps socket with four wires pre-wired to it. These wires can be seen in the [Courtesy/Dome Light Schematic](#) on the [page 62](#), these wire are:



- (2) **Orange:** 18 gauge, printed **#971 COURTESY LIGHT POWER**, this wire provides power from the console connector which is supplied power from the 10 amp DOME fuse on the fuse block. This fuse has battery power and is “hot” at all times. The other wire in this socket, printed **#971 GLOVE BOX LIGHT POWER**, provides power to the glove box switch.
- (2) **White:** 18 gauge, printed **#961 COURTESY LIGHT GROUND**. This wire is the ground wire that activates the courtesy light. When this wire is grounded it completes the voltage path causing the light to illuminate. This ground will come from either the door jamb switch or the headlight switch depending on if the door is opened or the headlight switch is turned to the “DOME LIGHT ON” position. The other wire in this connection, printed **#961 PASS. DOOR JAMB SWITCH**, will provide a ground source to the **#961** circuit from the passenger door jamb switch

This light socket uses both a 63 and 67 series bulb; a 67 series bulb has been included with this kit.

- Route the socket to a suitable mounting location under the dash. The light socket has a small hole in a mounting tab to allow mounting. Self-tapping screws have been provided as a mounting solution. Small zip ties, provide with this kit, may also come in handy if a suitable location for the light socket cannot accommodate mounting with a screw.

“Glove Box Switch”

The glove box switch is a simple plunger activated light that will illuminate the inside of the glove box when the glove box door is opened. The glove box switch requires a single power wire to function correctly as it grounds through its mounting.

The Painless harness includes a single wire for this connection. This wire will have a connector pre-installed, it is:

Orange: 18 gauge wire, printed **#971 GLOVE BOX LIGHT POWER**, this wire provides power to the switch through a couple of doubled up wire connections from the pass. Courtesy light and the console connector. Power for this wire comes from the 10 amp dome light fuse.

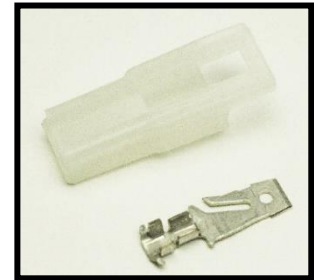

- See one of the following methods of connecting to a glove box switch. Both methods will require installing the terminal and connector seen in the photo to the right after the #971 has been routed and cut to length.

Factory Switch: The factory wire for the switch had a single terminal installed into the side of the switch. This wire can be difficult to remove and chances are you will break the switch trying to remove it. Painless recommends cutting the wire going to the switch and installing a terminal on connector as seen in the photo below. This will then allow the connector found on the Painless harness to plug right in.

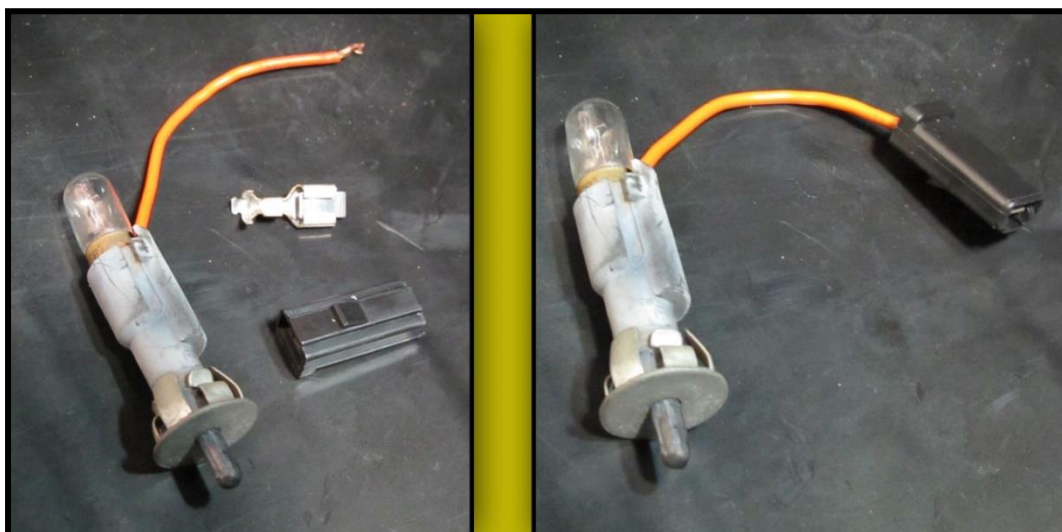

- With the factory switch now modified, install it into the dash and connect it to the **#971 ORANGE** wire on the Painless harness.

You can use the holes found in the edge of the glove box opening and small zip ties included with the kit to help secure the wire.

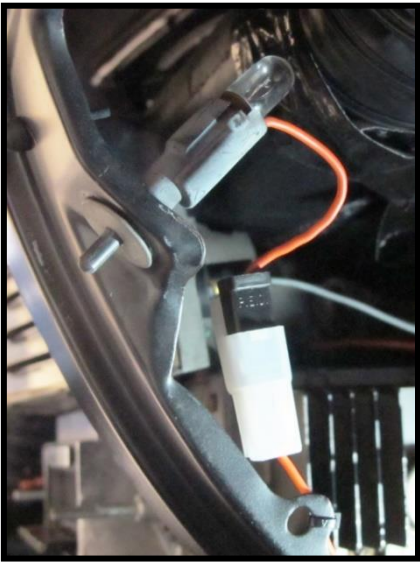

Aftermarket factory style switch: If you have purchased a new switch from one of the many companies that sell factory style replacements, chances are it came with a considerable amount of wire with connectors pre-installed, like shown above.

- Plug the orange **#971** wire on the Painless harness into the mating connector found on your new switch. The other connector on your switch will not connect to anything, in most cases it was used to plug into clocks found on other GM vehicles.

“Passenger Side Door Jamb Switch”

The passenger side door jamb switch will be the last connection on the passenger side of the vehicle’s interior.

The passenger side door jamb switch will be a one wire connection with a small insulated terminal pre-installed; a section label reading “PASS DOOR JAMB SWITCH” will be found on this wire. This wire will be:

White: 16 gauge, printed **#961 PASS. DOOR JAMB SWITCH**, this wire will provide a ground source from the jamb switch to the courtesy lights and the dome light. This ground will activate the lights, causing them to illuminate when the door is open. This wire can be seen in the [Courtesy/Dome Light Schematic](#) on [page 62](#).

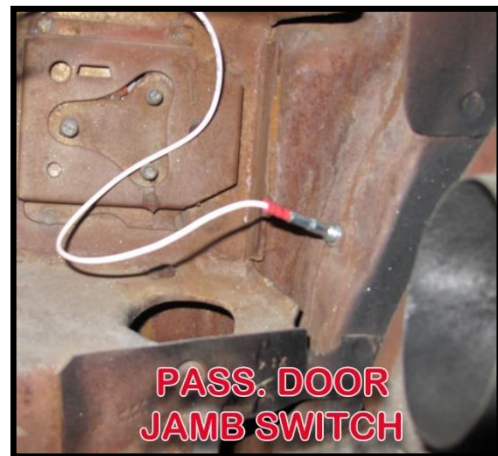

- Route this white **#961** wire to the passenger side door jamb switch and connect. You may find that there is extra length on this wire, this is to account for those with aftermarket AC mounted under the dash.

Gauge Cluster Harness

A gauge cluster harness has been provided with your new Painless kit. This harness will allow for an easy inline connection to the chassis harness making the installation, and any future removal, of the instrument panel...well, Painless.

The included sub harness is set up to be connected to factory indicator light gauge clusters as well as super sport, SS, clusters. This harness can also be modified to fit aftermarket gauges like those made by Auto Meter, Dakota Digital, Classic Instruments, etc. This harness does not support any speed warning connections on clusters with that option.

The pictures on the following on the following pages show the cluster removed from the plastic dash trim, your gauge cluster does not have to be removed from the dash trim for installation.

On the next two pages you will see a diagrams showing the back of the 2 different styles of the clusters used on Chevelles; indicator light and Super Sport clusters. The colored text shown in the diagrams corresponds to the color of the activation wire found on the harness to help identify which sockets/connectors go where. Wire color can also be found stamped into the metal of the cluster itself.

- Begin by installing the bulbs supplied with this kit into the sockets.

Those with a factory SS cluster will need to unplug the temp pigtail, preinstalled on the gauge cluster harness. This 2-pin connector will now plug into the tempo gauge. Also, SS clusters will not require bulbs into the oil pressure or Alt. sockets found on the gauge cluster harness. As noted on [page 3](#), this harness does not have connections for the Ammeter found on SS gauge clusters. The factory ammeter will not read correctly with a new wire harness installed. Those with an indicator cluster will use the harness as is, with the temp pigtail plugged in.

Any sockets that are not being used will need to have the ends taped, as shown, to avoid the wires protruding from the sockets and shorting to ground.

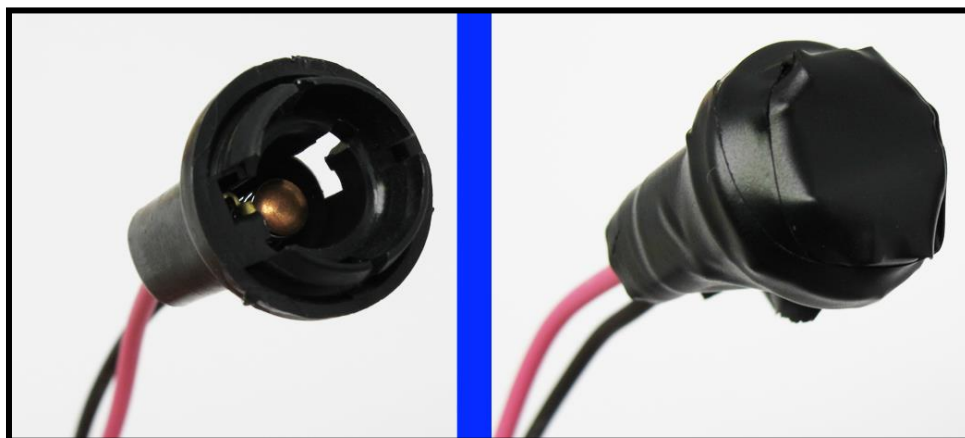

- Using the diagrams on the following pages, insert the sockets into their correct location. The ring terminal found on the gauge cluster harness will connect to one of the mounting bolts of the cluster, indicated as “GROUND” on the right side of the diagrams.

Factory 1968 Indicator Cluster



Factory 1968 Super Sport Cluster:



- Your cluster may or may not have a clock, as shown below. The clock is a simple one wire connection, as it only requires a power source. If you do not have a clock, simply zip tie the clock connection to the gauge harness.

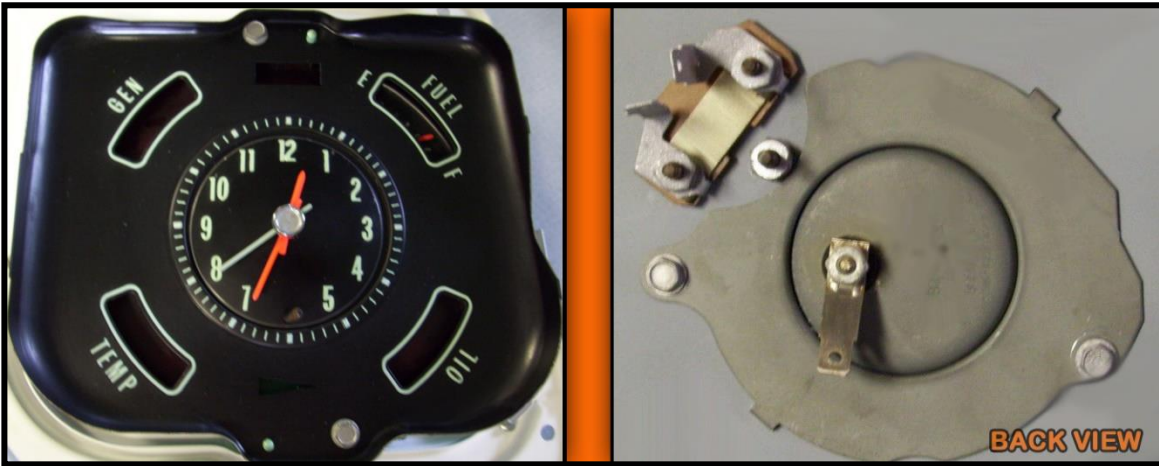

- In some cases the factory clock location may have an aftermarket tachometer installed. These are tachs specifically designed to fit in the clock location for 1968 clusters. Connection to these special tachs can be made by removing the connector on the Painless gauge harness labeled "TACH"; this connection is for the rolling tach found on some Super Sport clusters. With the connector removed, splice the brown signal wire from the gauge harness to the signal wire on the tach, and the pink power wire from the gauge harness to the power wire on the tach.

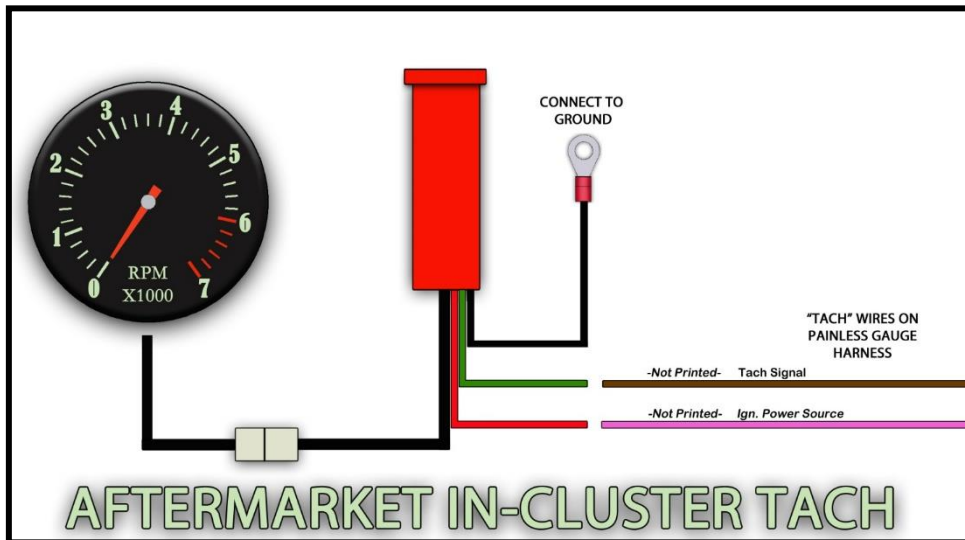

- At this time, if the cluster is removed from the dash trim, reinstall it onto the trim.

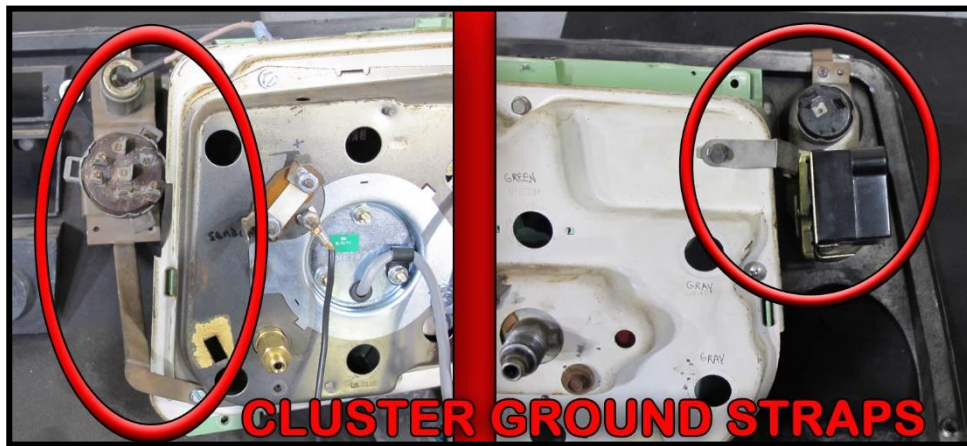

- Make sure the grounding straps for lighter/ignition switch and the headlight/wiper switch are installed on either side of the cluster. These help provide a ground signal to the cluster and also ensure the switches have a ground source for proper operation of the lighter, wiper, and provide a ground for dome light activation with the headlight switch.

If you find that the metal straps have broken, which is often the case, a piece of scrap wire and ring terminals from the parts kit will provide an easy fix. Simply connect the cluster, using one of the retaining screws on the cluster, to one of the screws holding the metal strip around the switches, as shown below.

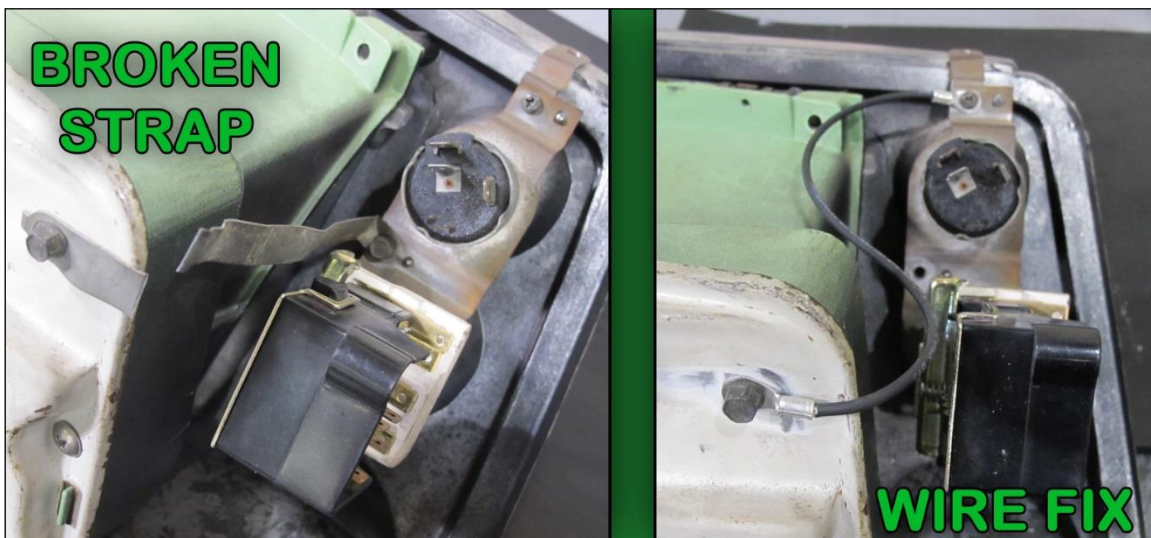

- The dash panel can now be set into place onto the steering column. The dash panel will be moved side to side and back and forth during the next few connections. To avoid scratching the column, wrap it with paper towel or a t shirt and make a couple quick revolutions around the column with electrical tape to hold the covering in place.



The above photo is of a 1969 model dash, which is why the gauge cluster and connection on the top of the column look different from your 1968.

Wiper Switch & Wiper Switch Ground

The wiper switch will send ground sources to the wiper motor and washer pump connections. A clean ground source from the metal strap on the dash trim to the body of the wiper switch is very important, which is why you will also find a wire labeled “WIPER GROUND” with the wiper switch wires.

The wiper switch connection of the Painless harness comes pre-terminated but without a connector pre-installed. Two connectors, a two pin and a single pin, have been provided in the parts kit; the original three pin connector is no longer available. All of the wires in the wiper switch section can be seen in the [Wiper Schematic](#) on the next page; these wires are:



Blue: 16 gauge wire, printed **#984 WASHER PUMP GROUND ACTIVATION**, this wire will send a ground signal to the washer pump causing the pump to begin sending fluid to the windshield spray nozzles.

Black: 16 gauge wire, printed **#977 WIPER SWITCH (HIGH)**, this is a ground signal to the high speed tab on the wiper motor.

Light Blue: 16 gauge wire, printed **#979 WIPER SWITCH (LOW)**, this is a ground signal to the low speed tab on the wiper motor.

Single Wire w/ a Ring Terminal

Black: 12 gauge wire, printed **#969 WIPER SWITCH GROUND**, this is the ground source to the wiper switch. This #969 wire is part of the integrated ground circuit of this Painless harness. It can also be seen in the [Ground Schematic](#) on [page 15](#).

- Begin by connecting the **#969** ground wire with the ring terminal to the metal strap connecting the wiper and headlight switches. Use one of the mounting screws that holds the strap to the trim panel to connect this ring terminal.

This ground is important as it provides the ground source the wiper switch needs for proper windshield wiper operation as well as the ground source for activating the dome light with the headlight switch. Originally this grounding was done through the mounting of the dash trim to the dash, as seen in the upper right corner of the photo above. Adding this ground wire ensures a good ground contact is being made to the grounding strap around the switches.



- Install the 2 wiper switch connectors onto the wires of the wiper switch as shown in the diagram on below. Once installed, use the same diagram to plug the harness into the wiper switch. The two pin connector will need to be installed with the blue wire closest to the center of the switch and the black wire on the outer terminal as shown in the [Wiper Schematic](#) below.

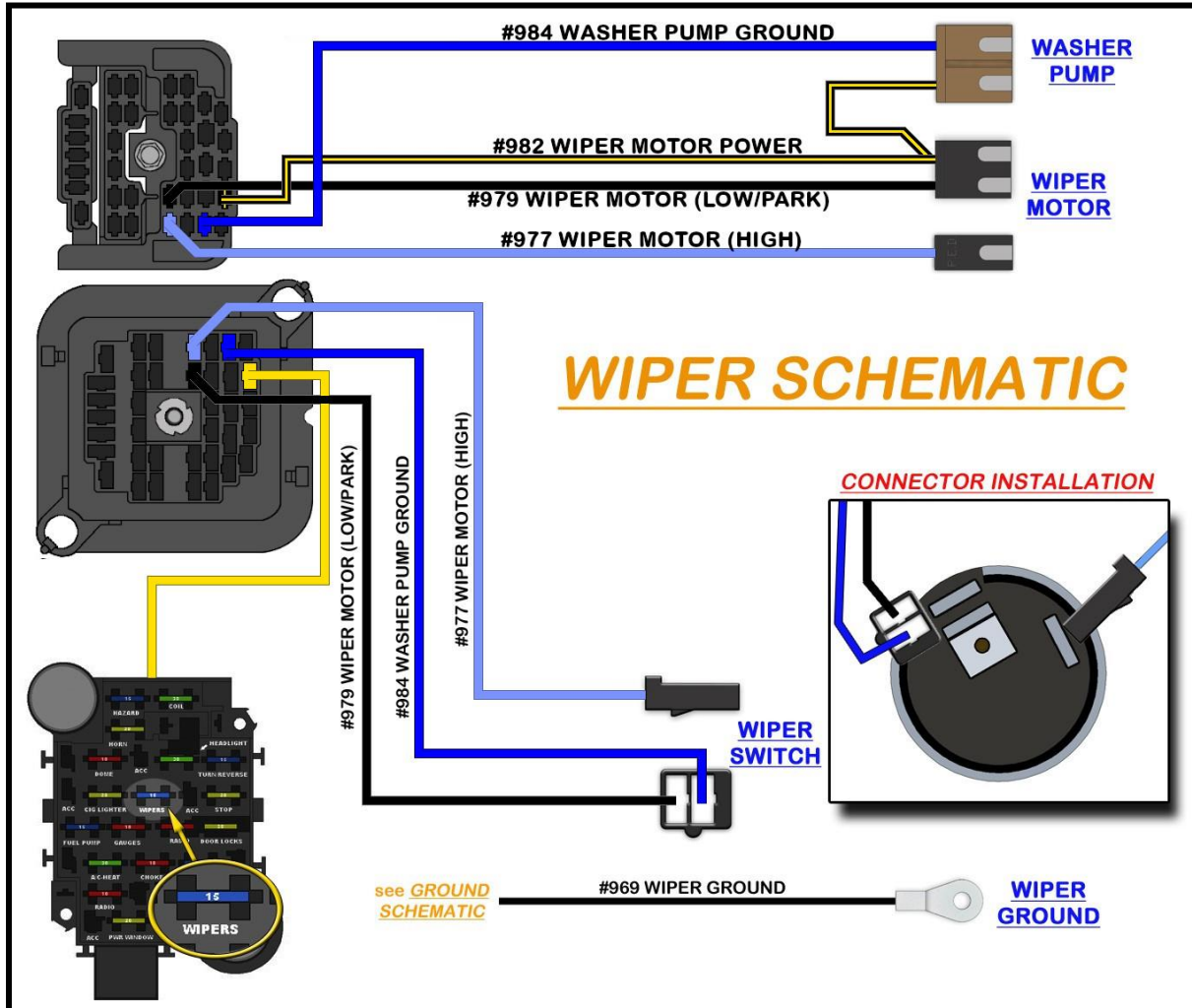

Headlight Switch

The headlight switch connection will control the function of the park/tail lights, headlights, gauge lights, and the dome/courtesy lights. This will be a three way switch:

- The first pull of the headlight switch will send power to illuminate the park lights, tail lights, and also the backlighting for the gauges.
- The second pull of the switch will still provide power to everything listed above, but will now send power to the dimmer switch which will then route power to the high beam or low beam headlights depending on the dimmer switch position.
- The third position is dome light/courtesy light control and gauge dimming. By rotating the knob to the left and right, you can dim/brighten the gauge backlighting. This is done through the rheostat (the coiled metal that looks like a spring) on the switch that resists the power going to the gauge lights. Turn the knob to the left to make the gauges brighter, all the way to the left you will feel a click, this click will provide a ground source out to the interior lighting circuit causing the dome/courtesy lights to come on without opening a door. Turning the knob to the right will turn the interior lights off and will begin to dim the gauge backlighting.

The headlight switch connection on the Painless harness comes with a large black eight pin connector pre-installed. The wires going into these connectors can all be seen in the [Headlight Switch Schematic](#) on the next page. These wires are:

8-pin connector:

Orange: 14 gauge wire, printed **#959 HEADLIGHT SWITCH POWER (PARK/TAIL)**, this wire supplies constant battery power for the park/tail lights as well as for the gauge backlighting. This wire comes from the 15 amp PARK/TAIL fuse on the fuse block.

Brown: 16 gauge wire, printed **#927 PARK LIGHT POWER**, this wire supplies power to the park lights and tail lights. This wire will have constant battery power any time the headlight switch knob is pulled out in both the first and second positions.

Light Blue: 14 gauge wire, printed **#907 DIMMER SWITCH POWER**, this wire supplies power to the dimmer switch for headlight operation. This wire will have constant battery power any time the headlight switch knob is pulled out in the second position.

Green: 16 gauge wire, printed **#930 POWER TO GAUGE/PANEL LIGHTS**, this wire provides power to the gauge lights. This wire will have constant battery power any time the headlight switch knob is pulled out in both the first and second positions.

If the knob of the headlight switch is rotated all the way to the right, you will not have power on this wire. If you do not have power to the gauge lights during testing, first check the knob position.

Red: 14 gauge wire, printed **#928 HEADLIGHT SWITCH POWER (HEADLIGHTS)**, this wire provides constant battery power to the headlight switch for headlight operation. This wire comes from the 30 amp HEADLIGHT fuse on the fuse block.

White: 16 gauge wire, printed **#961 DOME LIGHT GROUND (ACTIVATION)**, this wire provides the ground source for interior light activation. This wire will be grounded when the knob is turned all the way to the left. The white #961 is spliced into the door switch/ground wires of all the dome and courtesy lights. This wire can also be seen in the [Courtesy/Dome Light Schematic](#) on page 62.

- Connect the eight pin connector to the switch, the connector will only fit one way. Make sure the connector goes on straight as the tabs of the headlight switch can bend.

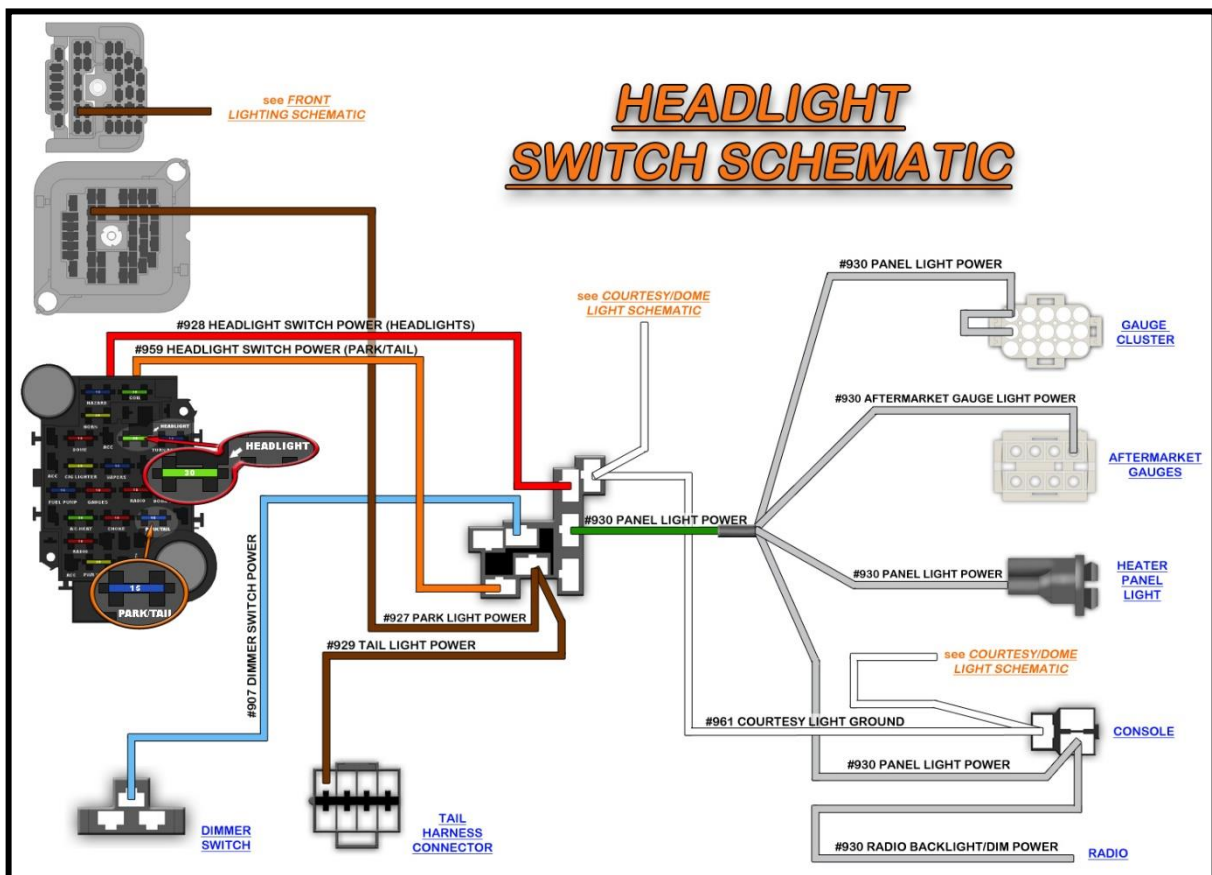
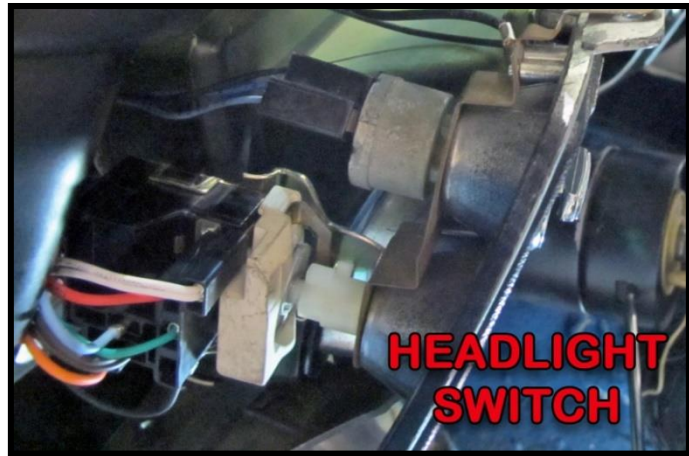

“Gauge Cluster Connection”

The gauge cluster on the Painless chassis harness will provide an easy way to unplug the gauge cluster from the chassis harness without having to undo each individual connection at the gauge cluster itself. This connection has all the wires needed for proper operation of the factory gauges, these wires can be seen in the [Gauge Cluster Schematic](#) on the previous page, they are:

Black: 16 gauge wire, printed **#969 INSTRUMENT CLUSTER GROUND**, this wire provides a ground source. This wire is tied into the integrated ground circuit and can be seen in the [Ground Schematic](#) on [page 15](#).

2 Gray: 18 gauge wires, one printed **#930 GAUGE LIGHT POWER**, these wires will provide a power to the cluster back lighting. The gray #930 is spliced with the other #930 wires coming from the headlight switch to things like the radio backlight/dim, panel lights, and gear indicator light. These wires will have power anytime the headlight switch is in the Park/Tail Lights ON or Headlights On position. These wires can also be seen in the [Headlight Switch Schematic](#) on [page 96](#).

Tan: 18 gauge wire, printed **#939 FUEL LEVEL SIGNAL**, this wire is a ground signal from the fuel level sending unit in the fuel tank. The resistance to ground will vary on this wire according to how much fuel is in the tank. This wire can also be seen in the [Tail Harness Schematic](#) on [page 106](#).

2 Pink: 18 gauge wires, both printed **#935 GAUGE POWER**, these wires provide a switched ignition power source to the cluster. These wires come from the 10 amp GAUGES fuse on the fuse block. This wire will have power anytime the key is in the ON/RUN position.

Green: 18 gauge wire, printed **#921 ENGINE TEMP SIGNAL/TEST**, this wire is a ground signal from the engine coolant sending unit and ignition switch. The resistance to ground will vary on this wire according to engine temperature. This wire will have a ground signal on it when the ignition key is in the “START” position. This is to flash the coolant temp light to the driver to let them know the bulb is in good operating condition. This will also cause the coolant temp gauge to momentarily swing to the high side. This wire can also be seen in the [Ignition Switch Schematic](#) on [page 101](#).

Brown: 18 gauge wire, printed **#923 TACH SIGNAL**, this wire is a ground signal from the negative side of the ignition coil. This wire can also be seen in the coil connection diagrams on [pages 40 & 41](#).

Blue/White: 18 gauge wire, printed **#922 OIL PRESSURE SIGNAL**, this wire is a ground signal from the oil pressure sending unit. The resistance to ground will vary on this wire according to oil pressure.

Tan/White: 18 gauge wire, printed **#968 LOW BRAKE SIGNAL**, this wire is a ground activation wire for the brake light on the cluster. This wire will be grounded, causing the light to illuminate when brake fluid pressure imbalance occurs or if the emergency brake is still applied.

Light Blue: 18 gauge wire, printed **#937 LEFT TURN INDICATOR**, this wire is a power activation wire for the left turn signal indicator. This wire will have interrupted switched ignition power, through the turn flasher, anytime the left turn signal is activated. It will also have interrupted switched battery power, through the hazard flasher, anytime the hazard switch is activated. This wire can also be seen in the [Turn Signal Switch Schematic](#) on page 65.

Light Green: 18 gauge wire, printed **#936 HIGH BEAM INDICATOR POWER**, this wire is a power activation wire for the high beam indicator. This wire will have power anytime the headlight switch is in the HEADLIGHT ON position and the dimmer switch in the HIGH BEAM position. This wire can also be seen in the [Front Exterior Light Schematic](#) on page 32.

Blue: 18 gauge wire, printed **#938 RIGHT TURN INDICATOR**, this wire is a power activation wire for the right turn signal indicator. This blue wire will have interrupted switched ignition power, through the turn flasher, anytime the right turn signal is activated. It will also have interrupted switched battery power, through the hazard flasher, anytime the hazard switch is activated. This wire can also be seen in the [Turn Signal Switch Schematic](#) on page 65.

- Plug the connector found on the gauge cluster harness, installed onto the gauge cluster on [page 87](#), into the Gauge Cluster connector found on the chassis harness. This connector will only plug in one way.

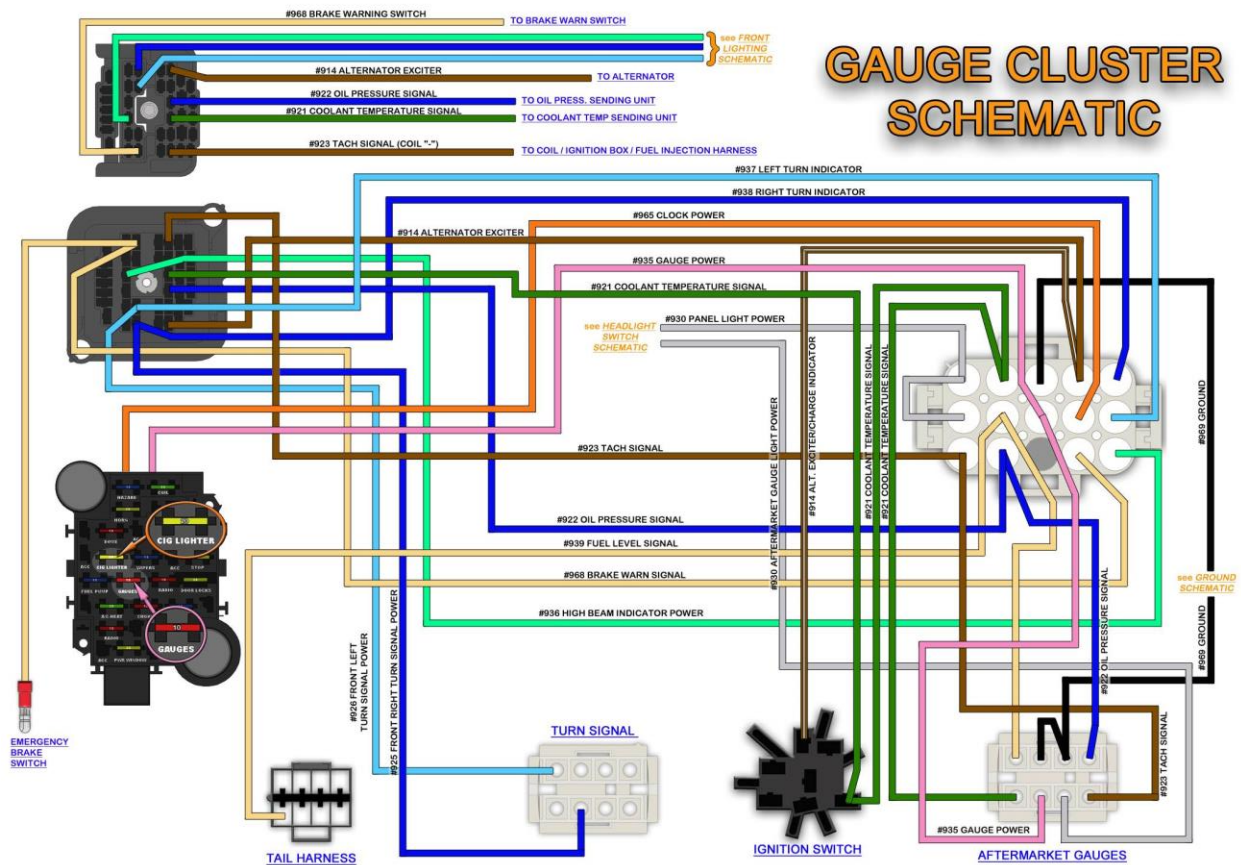

“Ignition Switch”

The ignition switch is one of the most important connections of a wire harness. Its function will control power to the switched ignition fuses on the fuse block and to the alternator exciter, as well as sending a start signal to the starter to allow engine operation.

The ignition switch connection consists of a single black connector with a section label reading “IGNITION SWITCH”. All wires going to the ignition switch connector can be seen in the [Ignition Switch Schematic](#) on [page 104](#).

The black connector is a seven pin connector with the following wires:

Red: 12 gauge wire, printed **#934 IGNITION SWITCH POWER**, this wire comes from a buss bar on the fuse block and feeds battery power to the ignition switch. This wire will have power at all times.

Orange: 12 gauge wire, printed **#933 SWITCHED (IGN) POWER TO FUSE BLOCK**, this wire provides the switched power source to the fuse block. This wire powers all of the switched power circuits to the harness, with the exception of the A/C-HEAT, RADIO, and POWER WINDOW fuses. This wire will only have power when the ignition switch is in the ON/RUN as well as the START position. This wire is in the same pin location on the black ignition switch connector as the Pink/Black wire.

Brown/White: 16 gauge wire, printed **#914 ALTERNATOR EXCITER**, this wire provides the alternator with a switched power source needed to excite the field of the alternator allowing it to begin to charge. This wire is in the same pin location on the black ignition switch connector as the Brown wire. This wire goes to a connector found in the instrument cluster section on this harness.

Green: 18 gauge wire, printed **#921 ENGINE TEMP SIGNAL**, this wire comes from the cooling temp sending unit on the engine. This wire is in the same pin location on the black ignition switch connector as the brown/white wire.

Green: 18 gauge wire, printed **#921 ENGINE TEMP SIGNAL/TEST**, this wire goes to the gauge cluster to provide the coolant temp gauge/light a ground signal for operation. This will provide a ground source to the coolant light on instrument clusters with indicator lights when the key in the start position. This will indicate that the bulb is operable. This will also cause a coolant temp gauge to swing to the high side during engine start.

Pink/Black: 16 gauge wire, printed **#931 SWITCHED POWER TO "COIL" FUSE**, this wire provides power from the ignition switch to the COIL fuse on the fuse block. This wire will have power when the ignition switch is in the ON/RUN position as well as the START position.

Purple/white: 12 gauge wire, printed **#919 START SIGNAL (FROM IGN. SW. TO N. SAFETY)**, this wire will send power to the neutral safety/clutch switch to engage the starter solenoid. This wire will only have power when the ignition switch is in the START position.

Brown: 12 gauge wire, printed **#932 ACCESSORY POWER**, this wire carries power to the accessory fuses on the fuse block. These fuses are the A/C-HEAT, RADIO, and POWER WINDOW fuses. This **#932** wire will have power when the ignition is in the ACCESSORY position and when it is in the ON/RUN position.

- Plug the ignition switch connector into the ignition switch. Make sure the locking tangs of the connector are fully inserted into the slots on the side of the ignition switch.

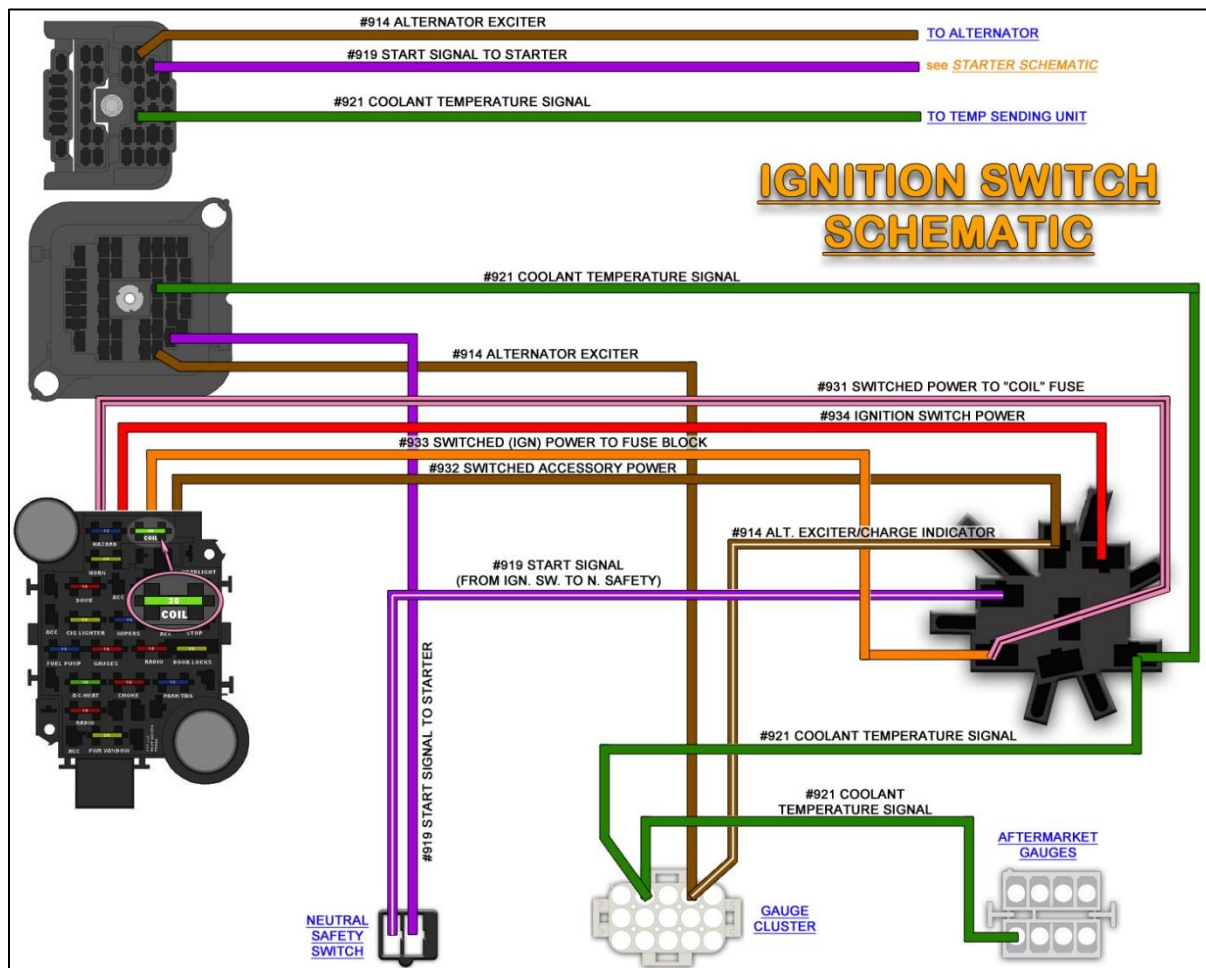
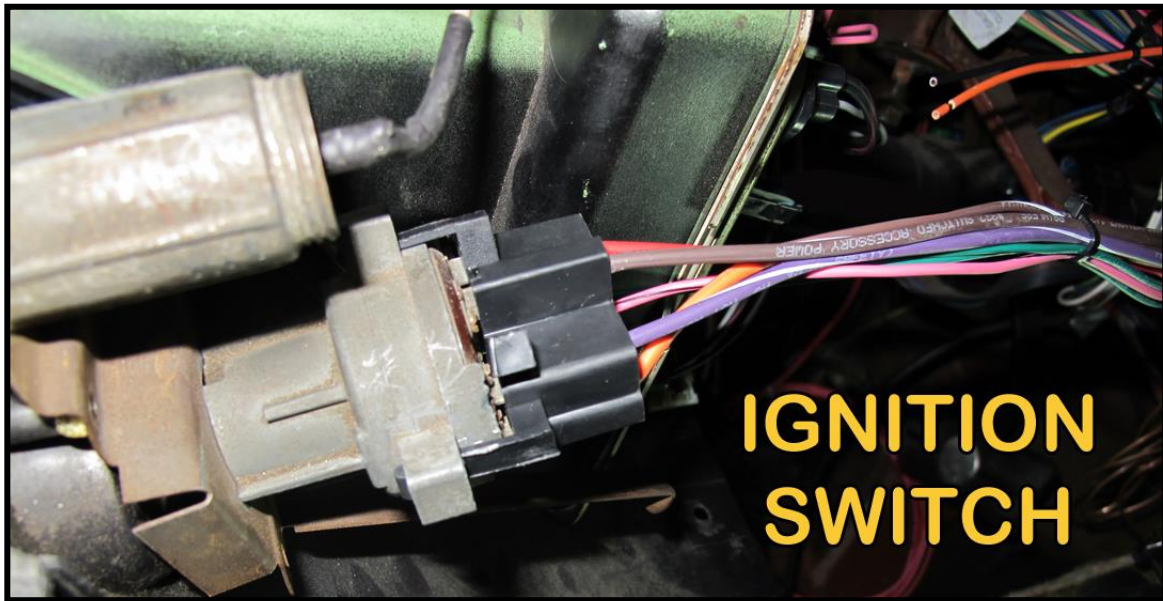

“Cigarette Lighter/Power Port”

The Cigarette Lighter/Power Port connection on the Painless harness is set up for a universal application since the factory connector is no longer produced and most sockets have been replaced by aftermarket sockets. Now a days, the cigarette lighter is more commonly used as a power port to charge cell phones and run other electronic components requiring a 12vDC power source.

The Cigarette Lighter/Power Port connection will be two wires with a section label reading “CIG. LIGHTER”, these wires are:

Orange: 16 gauge wire, printed **#903 CIGARETTE LIGHTER POWER**, this wire will provide constant battery power. This wire comes from the 20 amp CIG LIGHTER fuse on the fuse block and can be seen in the [Accessory Schematic](#) on the [page 103](#).

Black; 16 gauge wire, printed **#969 CIGARETTE LIGHTER GROUND**, this wire provides a ground source. This wire is tied into the integrated ground circuit and can be seen in the [Ground Schematic](#) on [page 15](#).

- Route the **#903** and the **#969** wires to the cigarette lighter/power port.
- Cut the wires to length and connect according to one of the following:
- Ring terminals and bullet/socket/spade style terminals have been provided in the parts kit to connect universal aftermarket lighters/power ports. Universal Lighter socket part #56458, seen in the photo, can be found at most local parts store.
- For those with a factory socket, you can cut the connector from your factory harness, leaving 3” or 4” of wire to create a pigtail, to splice it to the wire **ORANGE #903** of the Painless kit. The **BLACK #969** wire will not be needed. Splices have been provided in the parts kit.



“Radio”

The radio connection on the Painless harness is set up for a universal application since most Chevilles no longer have the factory radio in place. The two power wire colors used by Painless reflect the colors most aftermarket companies’ use on radios manufactured today.

The Painless harness includes four wires dedicated for a connection to the radio. The wires can be identified by a section label reading “RADIO”. These four wires are:

Yellow: 16 gauge wire, printed **#940 RADIO BATTERY POWER (MEMORY)**, this wire will provide the radio a battery power source that will allow the time and radio presets to remain every time the ignition is turned off. This wire comes from the 10 amp RADIO fuse found towards the middle of the fuse block. This wire can be seen in the [Accessory Schematic](#) on the next page.

Red: 16 gauge wire, printed **#941 RADIO SWITCHED POWER**, this wire will provide the radio with ignition switched power for operation. This wire will have power when the ignition switch is in the ACCESSORY and ON/RUN positions. This wire comes from the 10 amp RADIO fuse on the lower part of the fuse block. This wire can be seen in the [Accessory Schematic](#) on the next page.

Black/White: 16 gauge wire, printed **#969 RADIO GROUND**, this wire will supply a ground source to the radio. This wire is part of the integrated ground circuit of the Painless harness. This wire can be seen in the [Ground Schematic](#) on [page 15](#).

Gray: 18 gauge wire, printed **#930 RADIO BACKLIGHT DIM**, this wire will provide a power signal to the radio to dim the back lighting/display during low light conditions. On older radios this power source will illuminate the backlighting. The gray #930 is tied to the other #930 wires coming from the headlight switch to things like the gauge lights, panel lights, and gear indicator light. This wire will have power anytime the headlight switch is in the Park/Tail Lights ON or Headlights On position. This wire can be seen in the [Headlight Switch Schematic](#) on [page 96](#).

- Those reusing a factory radio, Yellow wire **#940** will not be used, this wire will need to have the end taped /insulated to avoid shorts. The factory connector will need to be reused. **RED #941** will connect to the factory yellow wire, **GRAY #930** will connect to the gray wire, and Black/White #969 will connect to the black wire. Splices and quick disconnect terminals have been provided in the parts kit.
- If you are using an aftermarket radio, refer to the manufacturer’s installation guide for proper connection. Splices and quick disconnect terminals have been provided in the parts kit.

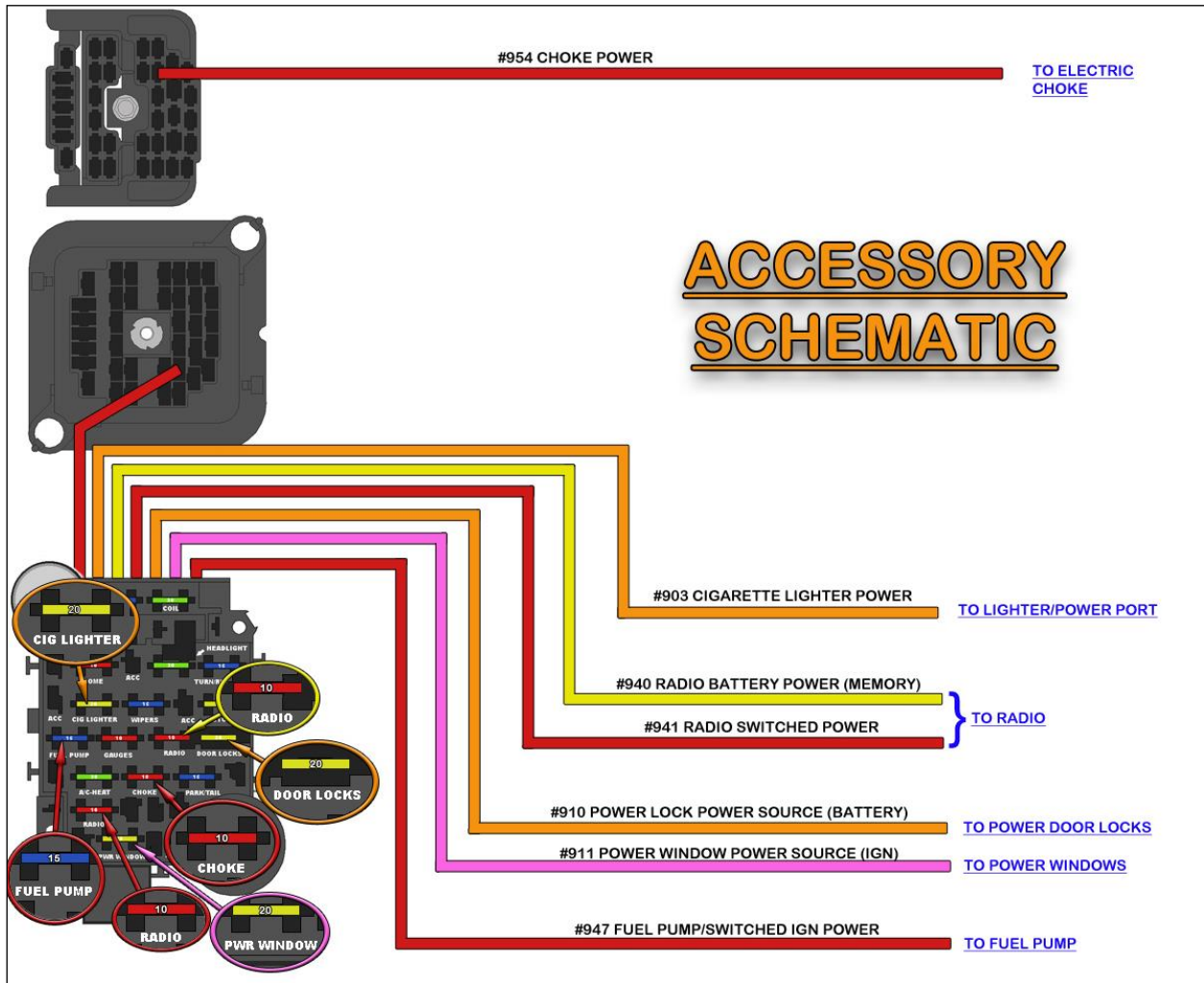

“Tail Section”

The last connection found on the interior harness that needs to be addressed is the tail harness connection. This connection will be found at the fuse block and will have a section label reading “Tail Section”. This will be a black eight pin connector, all wires can be seen in [Tail Harness Schematic](#) on [page 106](#), they are:

Yellow: 16 gauge wire, printed **#949 REAR LEFT TURN SIGNAL POWER**, this wire provides power to the left turn signal. This wire will have power anytime the turn signal is in the down position and the ignition switch is in the *ON/RUN* position or anytime the hazard switch is activated. This wire is also the brake light power and will also have power anytime the brake pedal is pressed. This wire can also be seen in the [Turn Signal Schematic](#) on [page 65](#).

Green: 16 gauge wire, printed **#948 REAR RIGHT TURN SIGNAL POWER**, this wire provides power to the right turn signal. This wire will have power anytime the turn signal is in the up position and the ignition switch is in the *ON/RUN* position or anytime the hazard switch is activated. This wire is also the brake light power and will also have power anytime the brake pedal is pressed. This wire can also be seen in the [Turn Signal Schematic](#) on [page 65](#).

Tan: 18 gauge wire, printed **#939 Fuel Level Sending Unit**, this wire will send a ground signal from the fuel level sending unit to wires for the fuel gauge at the gauge cluster and aftermarket gauge connector. This wire can also be seen in the [Gauge Cluster Schematic](#) on [page 94](#).

Black: 14 gauge wire, printed **#969 GROUND SUPPLY TO REAR LIGHTS**, this wire provides a ground source for the rear lights and comes from a splice that is tied to a series of other splices that ties all the grounds in this harness together. This wire, along with all the other ground wires and splices, can be seen in the [Ground Schematic](#) on [page 15](#).

Brown: 16 gauge wire, printed **#927 TAIL LIGHT POWER**, this wire will provide the tail lights and license plate light power. This wire receives power from the headlight switch and will have power anytime the headlight switch is pulled into the first or second positions. This wire can also be seen in the [Headlight Switch Schematic](#) on [page 96](#).

Light Green: 16 gauge wire, printed **#956 REVERSE LIGHT POWER**, this wire will provide power to the reverse or back up lights. This wire receives power from the reverse switch and will have power anytime the shifter is in the *REVERSE* position.

Orange: 18 gauge wire, printed **#971 DOME LIGHT POWER**. This power wire comes from the 10 amp DOME fuse on the fuse block; this fuse has battery power and is hot at all times. This wire can be also seen in the [Courtesy/Dome Light Schematic](#) on [page 62](#).

White: 18 gauge wire, printed **#961 DOME LIGHT GROUND**. This wire is the ground wire that activates the dome light. When this wire is grounded it completes the voltage path causing the light to illuminate. This ground will come from either door jamb switch or the headlight switch. This wire can also be seen in the [Courtesy/Dome Light Schematic](#) on [page 62](#).

Begin by examining the section label on the supplied tail harness to ensure you have the correct tail harness for your application. The section label should read "1968 CHEVELLE WH-517". WH-517 is simply an internal part number used by Painless to help us identify sub harnesses. If you find that you do not have the correct sub harness please contact the Painless tech line, 1-800-423-9696, and ask for a WH-517 harness.

- At this time, plug the tail harness into the tail section connector found of the interior/dash harness.
- In order to properly route the tail harness to the trunk, the driver seat/bench seat, and the rear seat back and bottom will need to be removed. This will allow the carpet to be pulled up and folded out of the way, allowing access to the driver side floor pan.
- With the seats out of the way, the harness can be routed under the carpet, to the trunk, as seen in the photo below. Use tape and the factory floor mounted harness hold downs to keep the harness in place.

The red wires in the photo below are speaker wires running to the speakers located in the package tray, these wires are not included in the Painless harness. If yours were removed during the removal of the factory harness, be sure to re install them now. The loom pre-installed on the tail harness has not be taped to allow routing the speaker wire inside the loom with the rest of the tail harness.

- Once routed to the back seat area, pass the tail harness through the large rectangular opening above the harness hold down and into the trunk, as seen below.

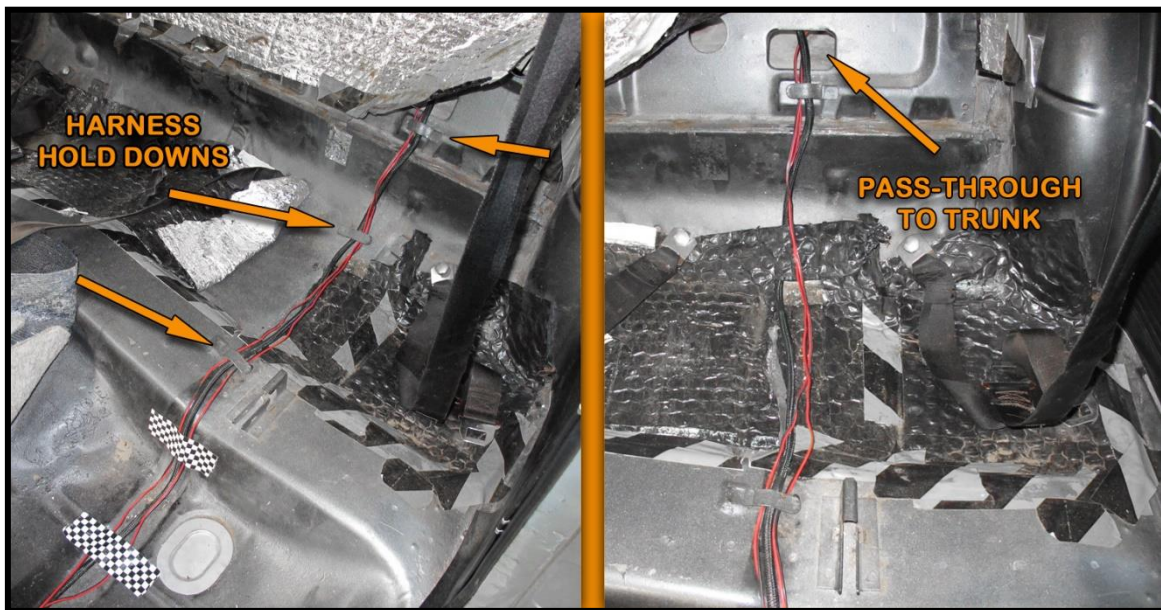

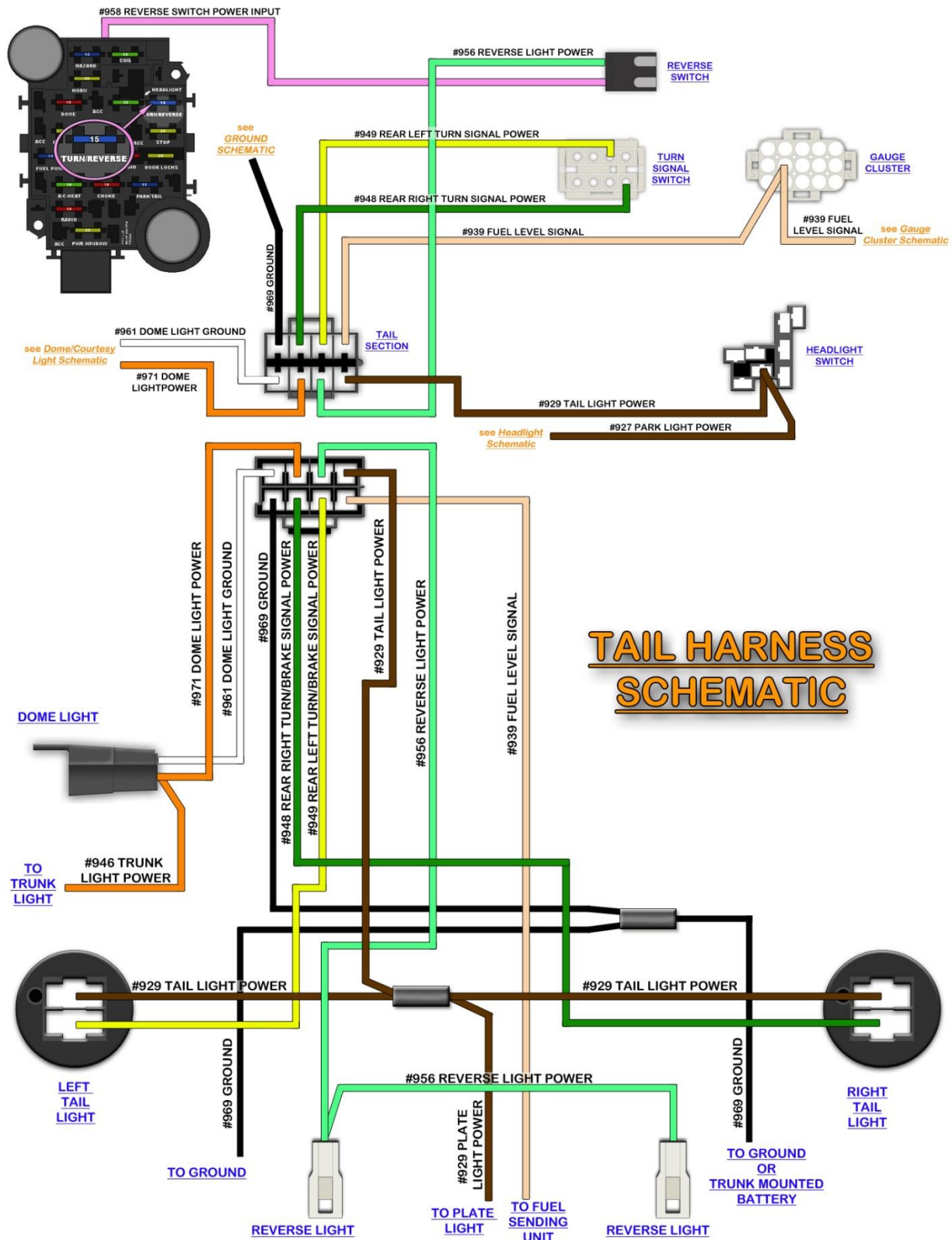

“Dome Light”

The dome light has constant battery applied to it. This light, along with the under dash courtesy lights, is ground activated by the door jamb switches and also by turning the headlamp knob counter clockwise.

The two wires of the Painless harness designated for dome light connections will have a two pin black connector pre-installed. These wires will plug into the factory dome light harness that runs from the dome light, behind the headliner, and into the trunk. These wires can be seen in [Tail Harness Schematic](#) on the previous page, they are:

(2) Orange: 18 gauge wire, printed **#971 DOME LIGHT POWER**. This power wire comes from the 10 amp DOME fuse on the fuse block; this fuse has battery power and is hot at all times. This wire can also be seen in the [Courtesy/Dome Light Schematic](#) on [page 62](#). Another orange wire leaves this connector, printed **#946 TRUNK LIGHT POWER**, and will provide a power source to the trunk/deck lid mounted light.

White: 18 gauge wire, printed **#961 DOME LIGHT GROUND**. This wire is the ground wire that activates the dome light. When this wire is grounded it completes the voltage path causing the light to illuminate. This ground will come from either door jamb switch or the headlight switch. This wire can also be seen in the [Courtesy/Dome Light Schematic](#) on [page 62](#).

- From the trunk, route the tail harness up towards the driver side wheel well, behind the trunk hinge. The factory wires coming from the dome light can be seen in this area.
- Plug the Painless harness into the connector for the dome light, as shown below. There is also a factory mounted harness clip that can be used to help hold the tail harness in place.

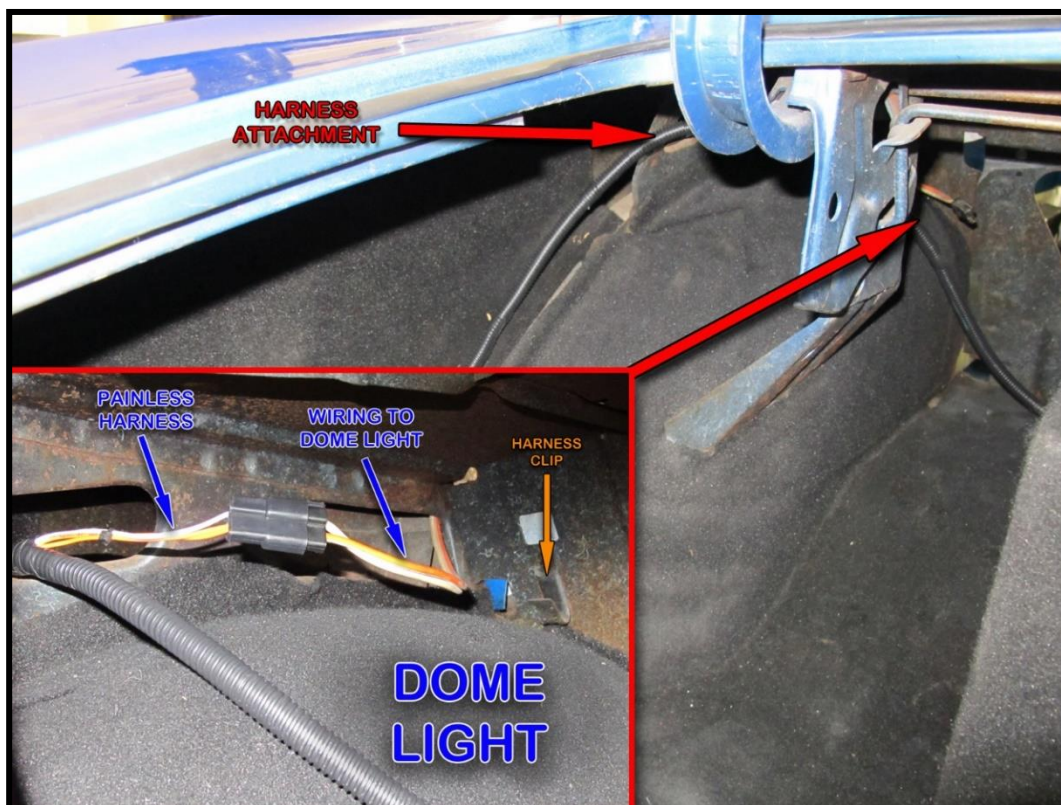

- Route the tail light harness towards the tail panel of the trunk. The harness will need to be attached to the “wheel well -quarter panel” brace as shown in the photo on the previous page and also in the photo to the right. A small ¼” hole can be drilled and a zip tie clip, like those used in the engine compartment, can be installed or you can simply install a large zip tie around the harness and to the brace.



- The tail harness will need to route to the rear of the car along the harness channel found on the driver side of the trunk opening. See the trunk light information below before routing the tail harness in this channel.

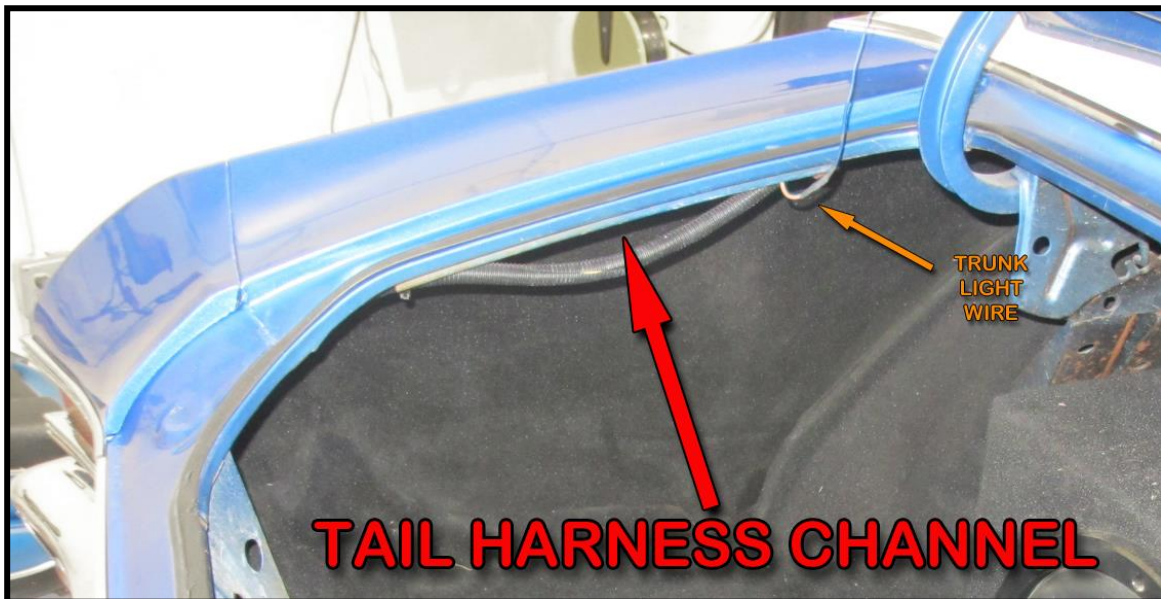

“Trunk Light”

Some vehicles will have a trunk light mounted to the underneath side of the trunk lid. This light requires a single power wire for proper operation. This wire can be seen in the [Tail Harness Schematic](#) on [page 106](#), it is:

Orange: 18 gauge wire, printed **#946 TRUNK LIGHT POWER**. This power receives power from the 10 amp DOME fuse on the fuse block through a connection at the dome light connector; this wire has battery power and is “hot” at all times.

- If a trunk light is not being used on your vehicle, install an insulated splice on the end of this wire to keep it from shorting to ground. With the wire now insulated, insert the wire into the loom on the tail harness to hide and secure it. The tail harness can now be routed to the tail panel in the aforementioned channel.
- Those with a trunk light, connect this **#946** wire to the wire coming from the trunk light socket. This wire from the trunk light socket, should exit the trunk/deck lid close to the driver side hinge.
- Using a single pin connector and mating terminal from the parts kit, connect the **#946** wire to the wire coming from the trunk light socket.
- The tail harness can now be routed to the tail panel in the aforementioned channel.

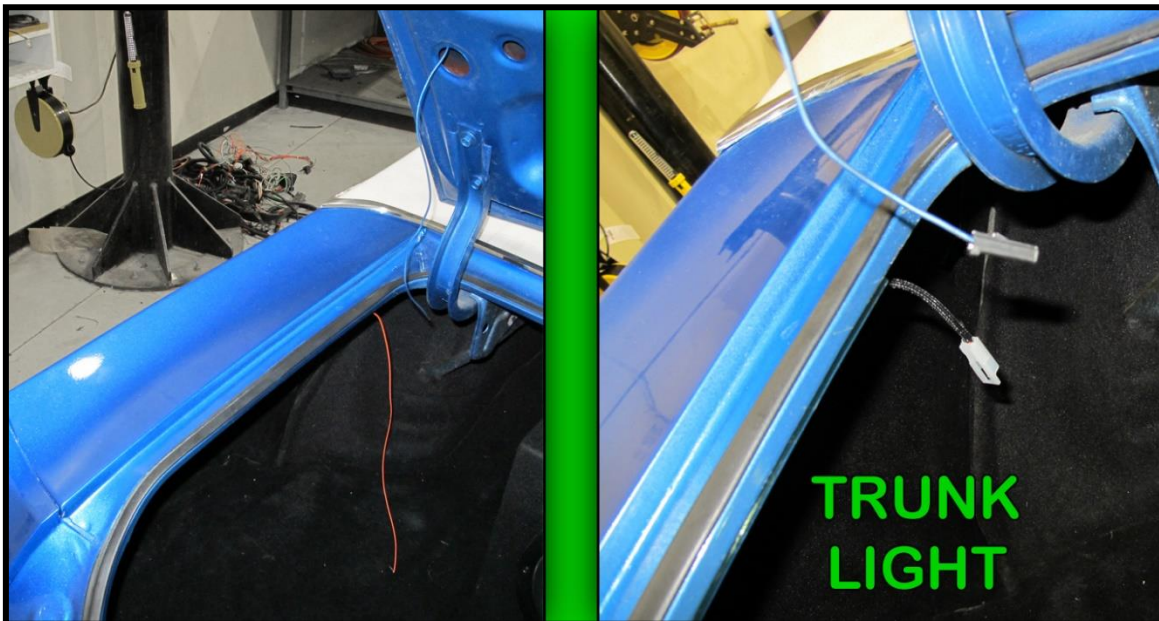

“Left Turn/Brake/Tail Light”

The left turn/brake/tail light connection will be accessed from the inside of the trunk. This connection will have two wire socket pre-installed. These wires can be seen in the [Tail Harness Schematic](#) on [page 106](#), they are:

Yellow- 18 gauge wire, printed **#949 REAR LEFT TURN/BRAKE SIGNAL POWER**, this wire is the turn signal power as well as the brake light power. This wire will have interrupted switched power from the turn flasher any time the left turn signal is activated and interrupted battery power from the hazard flasher any time the hazard switch is in the ON position. This wire will also have battery power anytime the brake pedal is pressed.

Brown: 18 gauge wire, printed **#929 TAIL LIGHT POWER**, this is a power wire for the tail light function. This wire will have power anytime the headlight switch is in the Park/Tail Lights ON or Headlights ON position.

- Before plugging the light socket in, first clean the opening in the tail light with a piece of sandpaper or Scotch Brite. This will ensure the socket gets a good clean ground source from the tail light bucket. The sandpaper or Scotch Brite will remove any oxidation, paint, or dirt that may have accumulated around the old socket.



- Locate an 1157 bulb from the parts kit, this will be one of the larger bulbs with 2 filaments and 2 contacts on the bottom of the bulb. Apply a very small amount of the provided dielectric grease to the bulb base as previously shown on [page 29](#) when installing bulbs into the front left turn signal socket. Insert the bulb into the socket pre-installed on the tail harness, notice the offset keying of the bulb and the socket and ensure the bulb is installed properly.
- Paying attention to the keyway on the tail light housing and the key on the tail light socket, insert the socket into the tail light housing.

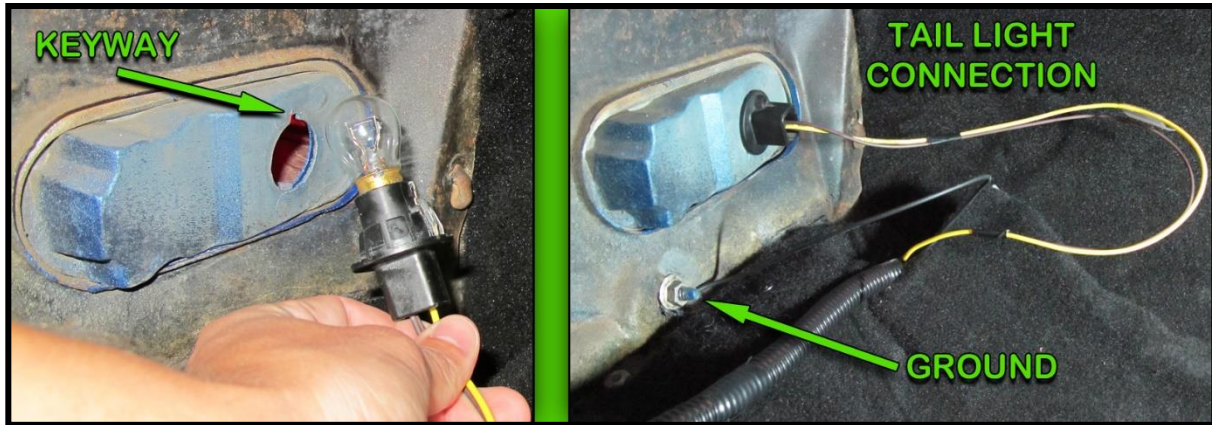

“Ground”

To further insure the tail light socket receives an adequate ground, a ground wire has been supplied in the tail harness. This wire can be seen in the [Tail Harness Schematic](#) on [page 106](#), it is:

Black: 16 gauge wire, printed **#969 GROUND**, this wire provides a ground source for the Turn/Brake/Tail Light and tail panel. This wire comes from a splice that is tied to a series of other splices that ties all the grounds in this harness together.

- Locate the stud below the tail light housing that holds the tail light to the tail panel. This stud will allow for a good ground connection to the tail light housing. This stud can be seen in the photos on the previous page.
- Remove the nut on this stud. If the threads have rust, paint, or any other build up, clean the threads with a wire brush or a scotch brite. DO NOT USE sand paper or anything that will damage the threads.
- Route the **#969** wire to this stud and cut it to length and strip ¼” of insulation.
- Locate a ring terminal from the parts kit that fits the stud and crimp onto the #969 ground wire. Once the terminal is crimped, install it onto the stud and reinstall the retaining nut

“Reverse Light”

This connection will have a section label reading “REVERSE LIGHT” and will have a white single pin connector pre-installed and can be seen in the [Tail Harness Schematic](#) on [page 106](#), it is:

- (2) **Light Green:** 18 gauge wires, both printed **#956 REVERSE LIGHT POWER**, these wires will provide power to the reverse or back up lights. One wire receives power from the reverse switch and will have power anytime the shifter is in the *REVERSE* position. The other wire in this connector provides power over to the passenger side reverse light.

Connection of the reverse light will depend on what style lights you have. Most will have bumper mounted lights and will have a pigtail that enters through the trunk floor. Some will have tail light housing mounted reverse lights that came on “300” model Chevelles. A picture on the next page shows both versions of tail lights offered by GM in 1968.

- For those with bumper mounted reverse lights, route the connector on the Painless harness to the wire coming through the trunk pan that connects to the reverse light and connect. The connector on the Painless harness will plug directly onto this wire.
- Install a single filament 1156 bulb from the parts kit into the reverse light socket, use a little dielectric grease on the bulb base. Removal of the reverse light lens will be required to access the socket.
- For those with 300 model reverse lights which are in the tail light housing, contact Painless and order part # **PP-713**. This will be a bag with 2 pigtails labeled “**1968 - "300" MODEL REVERSE LIGHT**”. It is not supplied due to a lack of usage by most customers.

The PP-713 pigtails will plug directly onto the reverse light connector on the Painless harness into the connector on the pigtail.



- For those not wanting to order/wait for the pigtails, mating connectors and terminals have been included in the parts kit to allow you to build your own pigtails by re-using your factory reverse light sockets. Simply cut the lamp socket from your original harness, leaving about 7” of wire and install the terminal and connector seen above onto the wire. This pigtail will now plug onto the reverse light wires found on your new Painless harness.

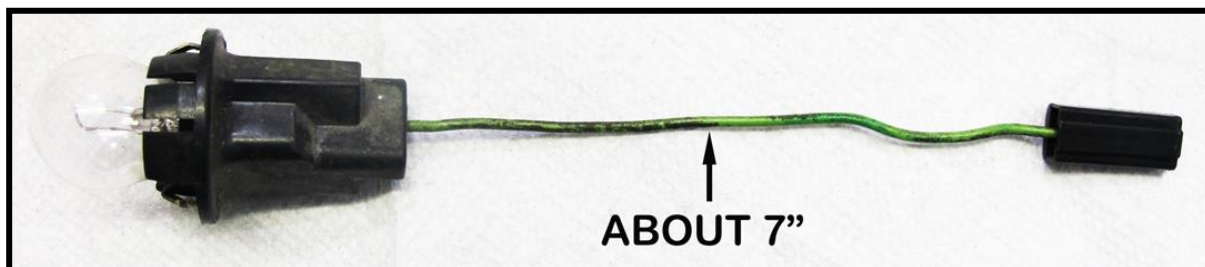



Tail Panel Routing

The remainder of the tail harness will now be routed over to the passenger side of the car along the tail panel and through the trunk latch brace.

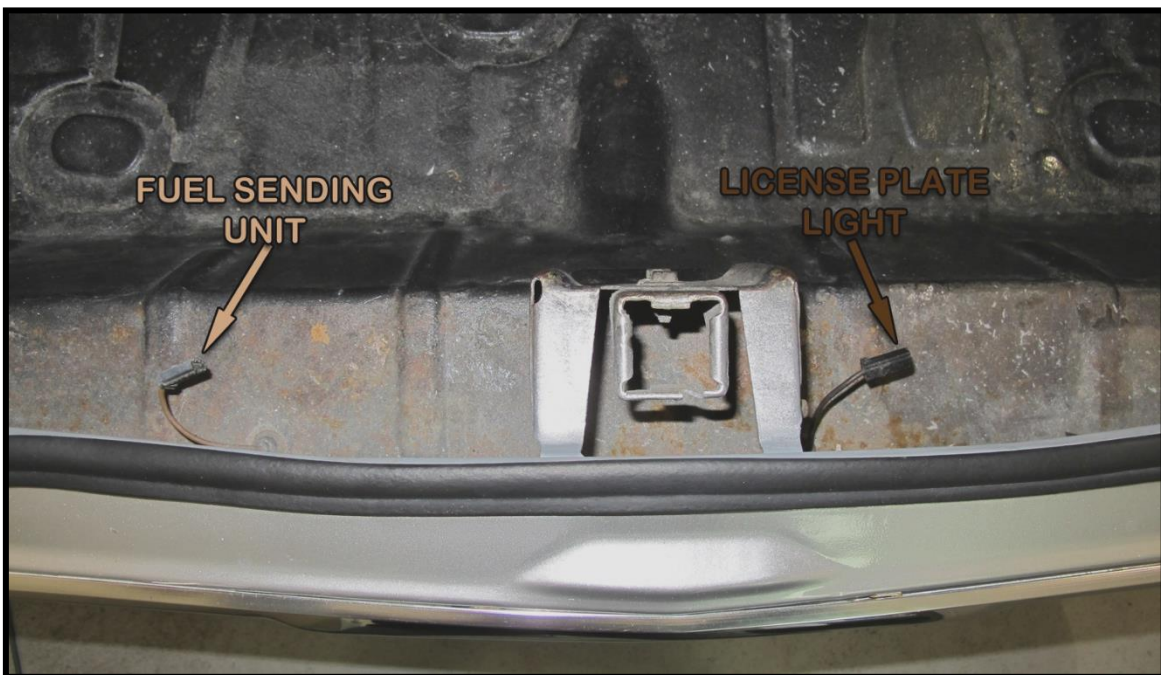

“Fuel Sending Unit”

The fuel sending unit connection will be a one wire connection. This wire will send a resisted ground source from the fuel level sending unit inside the fuel tank, up to the fuel gauge on the dash. This resistance is based off how much fuel remains in the tank, which causes the needle on the gauge to move between empty and full.

The wire provided in the Tail Harness will have a section label reading “FUEL SENDER”. This wire will have a single pin black connector pre-installed, this wire is:

Tan: 18 gauge wire, printed **#939 FUEL LEVEL SIGNAL**, this wire will a ground signal. It can be seen in the [Tail Harness Schematic](#) on [page 106](#).

- Locate the factory wire coming through the trunk floor, just below the trunk latch. Route the tan **#939** wire to this connection and cut to length.

If you do not have a factory wire coming from the fuel sending unit, extra length has been given to the **#939** wire to allow it to be routed directly to the fuel sending unit on the top of the fuel tank.



- For those with a factory connection in the trunk, a single pin connector and terminal has been provided in the parts kit, seen in the photo to the right and on the previous page. Install this terminal and connector and connect it to the single pin connector found on the factory wire coming from the fuel level sending unit.
- For those without a factory pigtail, a #10 ring terminal and nut have been provided in the parts kit to make your connection directly to the fuel level sending unit on top of the fuel tank.



“License Plate Light”

The plate light is the next connection needing to be made. The light only requires one wire as the light sockets grounds itself through the housing. The wire in the Painless harness for this function will have labels reading “PLATE LIGHT”. This wire is:

Brown: 18 gauge wires, printed **#929 PLATE LIGHT POWER**, this wire provides power for the license plate light function. This wire will have power anytime the headlight switch is in the Park/Tail Lights ON or Headlights ON position. This wire, along with all the other wires and splices it is associated with, can be seen in the [Tail Harness Schematic](#) on [page 106](#).

- Locate the factory wire coming through the trunk floor, just below the trunk latch. Route the brown **#929** wire to this connection and cut to length.

If you do not have a factory wire coming from the plate light, extra length has been given to the **#929** wire to allow it to be routed directly to the license plate light or whatever length of wire may be coming from the plate light.

- For those with a factory connection in the trunk, a single pin connector and terminal has been provided in the parts kit, seen in the photo to the right. Install this terminal and connector onto the **#929 PLATE LIGHT POWER** wire and connect it to the single pin connector found on the factory wire coming from the plate light.



- Splices have been provided in the parts kit for those who have a plate light which has had the factory connector cut.

“Reverse Light”

The reverse light connection will have a white single pin connector pre-installed and can be seen in the [Tail Harness Schematic](#) on [page 106](#),

Light Green: 18 gauge wire, printed **#956 REVERSE LIGHT POWER**, this wire will provide power to the reverse or back up lights. One wire receives power from the other reverse light wire on the driver side and will have power anytime the shifter is in the *REVERSE* position.

- Connect this wire according to the instruction given for the reverse lights given on [page 111](#).

“Ground”

For those with trunk a mounted battery, a ground wire has been supplied in the tail harness to connect all of the integrated ground wires throughout the entire chassis harness back to the negative side of the battery. If your battery is still in the engine compartment, this ground connection was handled during the front exterior lighting connections and this ground connection will just provide a chassis ground source. This wire can be seen in the [Tail Harness Schematic](#) on page 106, it is:

Black: 10 gauge wire, printed **#969 GROUND**, this wire provides a ground source to the rest of the #969 wires in the Painless chassis harness.

For those with a trunk mounted battery:

- Route this **#969** wire to the negative battery terminal or to where ever the negative battery cable connects to the frame, which ever option offers the cleanest and easiest install.
- Cut the **#969** wire to length and strip ¼” of insulation. Locate a ring terminal from the parts kit that fits the connection point and crimp onto the **#969** ground wire. Once the terminal is crimped, install the **#969** wire to its connection point

For those with a factory engine compartment mounted battery:

- Locate the stud below the tail light housing that holds the tail light to the tail panel. This stud will allow for a good ground connection to the tail light housing.
- Remove the nut on this stud. If the threads have rust, paint, of any other build up, clean the threads with a wire brush or a scotch brite. DO NOT USE sand paper or anything that will damage the threads.
- Route the **#969** wire to this stud and cut it to length and strip ¼” of insulation.
- Locate a ring terminal from the parts kit that fits the stud and crimp onto the #969 ground wire. Once the terminal is crimped, install it onto the stud and reinstall the retaining nut

“Right Turn/Brake/Tail Light”

The last connection left to discuss will be for the right Turn/Brake/Tail Light. This connection will have a two wire socket pre-installed. These wires can be seen in the [Tail Harness Schematic](#) on [page 106](#), they are:

Green: 18 gauge wire, printed **#948 REAR RIGHT TURN/BRAKE SIGNAL POWER**, this wire is the turn signal power as well as the brake light power. This wire will have interrupted switched power from the turn flasher any time the right turn signal is activated and interrupted battery power from the hazard flasher any time the hazard switch is in the ON position. This wire will also have battery power anytime the brake pedal is pressed.

Brown: 18 gauge wire, printed **#929 TAIL LIGHT POWER**, this is a power wire for the tail light function. This wire will have power anytime the headlight switch is in the Park/Tail Lights ON or Headlights ON position.

- Before doing anything with the actual connection or light socket, clean the opening in the tail light with a piece of sandpaper or Scotch Brite, as done on the left side of the car on [page 110](#).
- Insert the bulb into the socket pre-installed on the tail harness, notice the offset keying of the bulb and the socket and ensure the bulb is installed properly.
- Paying attention to the keyway on the tail light housing and the key on the tail light socket, insert the socket into the tail light housing.

TESTING THE SYSTEM

Use a small (10 amp or less) battery charger to power up the vehicle for the first time to test the circuits. If there is a problem anywhere, the battery charger's low amperage and internal circuit breaker will provide circuit protection.

During testing, do not try to start the vehicle. The low amperage of the battery charger will not be enough to engage the starter solenoid. Also, only test one component at a time. Meaning, turning a component off before turning another component on. When you leave a component on, and then trying to test others, it can cause problems leading you to believe you have issues with the way something was installed.

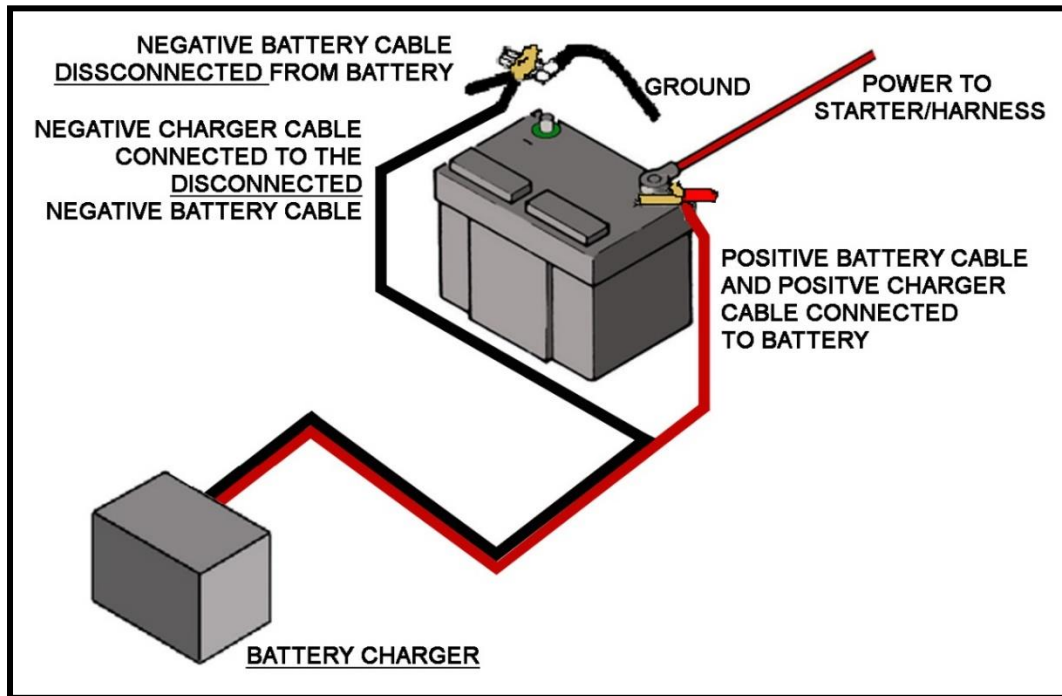

- Make sure the Negative Battery cable is connected to the frame or engine block, and make sure there is a ground between the engine and frame. **The negative battery cable should still be disconnected from the Battery** as instructed on [page 3](#).
- Connect the Battery Positive cable to the Positive side of the Battery and also make sure this cable is connected to the B+ side of the Starter Solenoid.
- Connect the Battery Charger's NEGATIVE cable to the automobile chassis, engine block or to the disconnected Negative Battery cable. **Do NOT connect the Battery Charger's NEGATIVE cable to the Battery.**
- Connect the Battery Charger's POSITIVE cable to the automobile's positive battery terminal lug.
- **INDIVIDUALLY** turn on each light, ignition, wiper circuit, etc. and check for proper operation. Do not try to start the vehicle.

Note: If you try to test more than one circuit at a time, the charger will not provide enough amperage for each circuit to work correctly.

- After all circuits have been checked, disconnect the battery charger and attach the vehicles negative battery cable to the battery.
- Once testing is complete, re-install any panels, lens, or other parts that were removed during the harness installation. You are now finished installing this Painless Harness, congratulations!

WIRE INDEX

- The index is listed in the same order in which the manual instructed components to be connected.
- The **UNDERLINED** descriptions indicate the separate harnesses and sections found throughout the harness.
- The **BOLD** titles above the tables indicate components/connection points.
- The descriptions shown in *ITALICS* are NOT actually printed on the wire. These are simply shown to provide the circuit number and the function in which that particular wire is associated.
- “STARTING POINT” simply means where the opposite end of that wire is located.

ENGINE HARNESS

LOW BRAKE SWITCH

PRINT	GAUGE	COLOR	PRINTED MESSAGE ON WIRE	STARTING POINT
YES	18	TAN	#968 BRAKE WARN SWITCH	ENGINE BULK HEAD

LIGHT SECTION

LEFT SIDE MARKER

PRINT	GAUGE	COLOR	PRINTED MESSAGE ON WIRE	STARTING POINT
YES	16	LTBLU	#926 FRONT LEFT TURN SIGNAL POWER	ENGINE BULK HEAD
YES	18	LTBLU	#926 FRONT LEFT TURN SIGNAL POWER	FRONT LEFT TURN SIGNAL
YES	18	BRN	#927 PARK LIGHT POWER	PARK LIGHT SPLICE

LEFT HEADLIGHT

PRINT	GAUGE	COLOR	PRINTED MESSAGE ON WIRE	STARTING POINT
YES	14	LTGRN	#908 HIGH BEAM POWER	HIGH BEAM SPLICE
YES	14	TAN	#909 LOW BEAM POWER	ENGINE BULKHEAD
YES	14	TAN	#909 LOW BEAM POWER	RIGHT HEADLIGHT
YES	14	BLK	#969 HEADLAMP GROUND	FRONT GROUND SPLICE

LEFT HIGH BEAM

PRINT	GAUGE	COLOR	PRINTED MESSAGE ON WIRE	STARTING POINT
YES	14	LTGRN	#908 HIGH BEAM POWER	HIGH BEAM SPLICE
YES	14	BLK	#969 HIGH BEAM GROUND	FRONT GROUND SPLICE

LEFT TURN SIGNAL

PRINT	GAUGE	COLOR	PRINTED MESSAGE ON WIRE	STARTING POINT
YES	18	LTBLU	#926 FRONT LEFT TURN SIGNAL POWER	LEFT MARKER LIGHT
YES	18	BRN	#927 PARK LIGHT POWER	PARK LIGHT SPLICE

HORN

PRINT	GAUGE	COLOR	PRINTED MESSAGE ON WIRE	STARTING POINT
YES	14	BLK/GRN	#924 HORN POWER	ENGINE BULK HEAD

RIGHT TURN SIGNAL

PRINT	GAUGE	COLOR	PRINTED MESSAGE ON WIRE	STARTING POINT
YES	18	BLU	#925 FRONT RIGHT TURN SIGNAL POWER	RIGHT MARKER LIGHT
YES	18	BRN	#927 PARK LIGHT POWER	PARK LIGHT SPLICE

RIGHT HIGH BEAM

PRINT	GAUGE	COLOR	PRINTED MESSAGE ON WIRE	STARTING POINT
YES	14	LTGRN	#908 HIGH BEAM POWER	HIGH BEAM SPLICE
YES	14	BLK	#969 HIGH BEAM GROUND	FRONT GROUND SPLICE

RIGHT HEADLIGHT

PRINT	GAUGE	COLOR	PRINTED MESSAGE ON WIRE	STARTING POINT
YES	14	LTGRN	#908 HIGH BEAM POWER	HIGH BEAM SPLICE
YES	14	TAN	#909 LOW BEAM POWER	LEFT HEADLIGHT
YES	14	BLK	#969 HEADLAMP GROUND	FRONT GROUND SPLICE

RIGHT SIDE MARKER

PRINT	GAUGE	COLOR	PRINTED MESSAGE ON WIRE	STARTING POINT
YES	16	BLU	#926 FRONT RIGHT TURN SIGNAL POWER	ENGINE BULK HEAD
YES	18	BLU	#926 FRONT RIGHT TURN SIGNAL POWER	FRONT RIGHT TURN SIGNAL
YES	18	BRN	#927 PARK LIGHT POWER	PARK LIGHT SPLICE

GROUND

PRINT	GAUGE	COLOR	PRINTED MESSAGE ON WIRE	STARTING POINT
YES	18	TAN	#969 BATTERY "-" / GROUND SOURCE	FRONT GROUND SPLICE

ENGINE HARNESS

WIPER MOTOR

PRINT	GAUGE	COLOR	PRINTED MESSAGE ON WIRE	STARTING POINT
YES	16	BLK	#979 WIPER MOTOR (LOW/PARK)	ENGINE BULKHEAD
YES	16	BLK/YLW	#982 WIPER MOTOR POWER	ENGINE BULKHEAD
NO	16	BLK/YLW	<i>#982 WASHER PUMP POWER</i>	WASHER PUMP
YES	16	LTBLU	#977 WIPER MOTOR (HIGH)	ENGINE BULKHEAD

WASHER PUMP

PRINT	GAUGE	COLOR	PRINTED MESSAGE ON WIRE	STARTING POINT
YES	16	BLK/YLW	<i>#982 WASHER PUMP POWER</i>	WIPER MOTOR
YES	16	BLK	#969 HIGH BEAM GROUND	FRONT GROUND SPLICE

ENGINE SECTION

PRINT	GAUGE	COLOR	PRINTED MESSAGE ON WIRE	STARTING POINT
YES	18	GRN	#921 COOLANT TEMPERATURE SIGNAL	ENGINE BULKHEAD
YES	18	BLU	#922 OIL PRESSURE SIGNAL	ENGINE BULKHEAD
YES	18	RED	#954 CHOKE POWER	ENGINE BULKHEAD

COIL/IGNITION SECTION

PRINT	GAUGE	COLOR	PRINTED MESSAGE ON WIRE	STARTING POINT
YES	16	WHT/ORG	#920 COIL POWER ("+")	ENGINE BULKHEAD
YES	18	BRN	#923 TACH SIGNAL (COIL "-")	ENGINE BULKHEAD
YES	16	YLW	#970 IGNITION BYPASS (COIL "+" TO STARTER "I")	*BAG

*The YLW #979 wire listed above is not installed in the harness, but is found in a separate bag accompanying this harness; it will not be needed in most applications

ALTERNATOR SECTION

PRINT	GAUGE	COLOR	PRINTED MESSAGE ON WIRE	STARTING POINT
YES	14	RED	#995 ALTERNATOR BATTERY POWER SAMPLE	BATTERY POWER SPLICE
YES	14	BRN	#914 ALTERNATOR EXCITER	ENGINE BULKHEAD
YES	6	RED	Has a section label reading: #915 ALTERNATOR OUTPUT	*BAG

*The RED #915 wire listed above is not installed in the harness, but is found in a separate bag accompanying this harness

STARTER SECTION

PRINT	GAUGE	COLOR	PRINTED MESSAGE ON WIRE	STARTING POINT
YES	8	RED	#916 BATTERY POWER SOURCE	BATTERY POWER SPLICE
YES	18	PUR	#919 STARTER SOLENOID "S" (START SIGNAL)	ENGINE BULKHEAD
YES	16	YLW	#970 IGNITION BYPASS (COIL "+" TO STARTER "I")	*BAG

*The YLW #979 wire listed above is not installed in the harness, but is found in a separate bag accompanying this harness; it will not be needed in most applications

ENGINE HARNESS (continued)

BLOWER MOTOR

PRINT	GAUGE	COLOR	PRINTED MESSAGE ON WIRE	STARTING POINT
YES	14	ORG	#967 BLOWER MOTOR POWER	ENGINE BULKHEAD

This concludes all connections/wires found in the Engine Harness.

INTERIOR HARNESS

DIMMER SWITCH

PRINT	GAUGE	COLOR	PRINTED MESSAGE ON WIRE	STARTING POINT
YES	14	LTBLU	#909 LOW BEAM POWER	INTERIOR BULK HEAD
YES	14	TAN	#907 DIMMER SWITCH POWER	HEADLIGHT SWITCH
YES	14	LT.GRN	#908 HIGH BEAM POWER	INTERIOR BULK HEAD

EMERGENCY BRAKE SWITCH

PRINT	GAUGE	COLOR	PRINTED MESSAGE ON WIRE	STARTING POINT
NO	18	TAN	#968 BRAKE WARN SIGNAL	ENGINE BULKHEAD

ACC (accessories)

PRINT	GAUGE	COLOR	PRINTED MESSAGE ON WIRE	STARTING POINT
YES	14	ORG	#910 POWER LOCK POWER SOURCE (BATTERY)	FUSE BLOCK/ LOCK FUSE
YES	14	PNK	#911 POWER WINDOW POWER SOURCE (IGN)	FUSE BLOCK/ WINDOW FUSE
YES	14	RED	#947 FUEL PUMP/SWITCHED IGN POWER	FUSE BLOCK/ FUEL PUMP FUSE

DRIVER DOOR JAMB SWITCH

PRINT	GAUGE	COLOR	PRINTED MESSAGE ON WIRE	STARTING POINT
YES	18	WHT	#961 DRIVER DOOR JAMB SWITCH	DRIVER COURTESY LIGHT
YES	18	WHT	#961 DOME LIGHT GROUND	TAIL HARNESS CONNECTOR

DRIVER COURTESY LIGHT

PRINT	GAUGE	COLOR	PRINTED MESSAGE ON WIRE	STARTING POINT
YES	18	ORG	#971 COURTESY LIGHT POWER	FUSE BLOCK/ DOME FUSE
YES	18	ORG	#971 COURTESY LIGHT POWER	TAIL HARNESS CONNECTOR
YES	18	WHT	#961 COURTESY LIGHT GROUND	HEADLIGHT SWITCH
YES	18	WHT	#961 COURTESY LIGHT GROUND	DRIVER DOOR JAMB SWITCH

BRAKE SWITCH

PRINT	GAUGE	COLOR	PRINTED MESSAGE ON WIRE	STARTING POINT
YES	16	WHT	#918 BRAKE SWITCH OUTPUT	TURN SIGNAL SWITCH
YES	16	ORG	#917 BRAKE SWITCH POWER INPUT	FUSE BLOCK/ STOP FUSE

TURN SIGNAL SWITCH

PRINT	GAUGE	COLOR	PRINTED MESSAGE ON WIRE	STARTING POINT
YES	18	BLK	#963 HORN RELAY GROUND ACTIVATION	FUSE BLOCK/ HORN RELAY
YES	16	LTBLU	#926 FRONT LEFT TURN SIGNAL POWER	INTERIOR BULKHEAD
YES	16	BLU	#925 FRONT RIGHT TURN SIGNAL POWER	INTERIOR BULKHEAD
YES	16	BRN	#951 HAZARD SWITCH POWER	FUSE BLOCK/ HAZARD FLASER
YES	16	PUR	#952 TURN SIGNAL SWITCH POWER	FUSE BLOCK/ TURN FLASHER
YES	16	YLW	#949 REAR LEFT TURN SIGNAL POWER	TAIL HARNESS CONNECTOR
NO	16	GRN	#948 REAR RIGHT TURN SIGNAL POWER	TAIL HARNESS CONNECTOR
YES	16	WHT	#918 BRAKE SWITCH OUTPUT	BRAKE SWITCH

NEUTRAL SAFETY/CLUTCH SWITCH

PRINT	GAUGE	COLOR	PRINTED MESSAGE ON WIRE	STARTING POINT
YES	12	PUR/WHT	#919 START SIGNAL (FROM IGN. SW. TO N. SAFETY)	IGNITION SWITCH
YES	12	PUR	#919 START SIGNAL TO STARTER	INTERIOR BULKHEAD

REVERSE SWITCH

PRINT	GAUGE	COLOR	PRINTED MESSAGE ON WIRE	STARTING POINT
YES	16	PNK	#958 REVERSE SWITCH POWER INPUT	FUSE BLOCK/ TURN-REVERSE FUSE
YES	16	LTGRN	#956 REVERSE LIGHT POWER	TAIL HARNESS CONNECTOR

CONSOLE

PRINT	GAUGE	COLOR	PRINTED MESSAGE ON WIRE	STARTING POINT
YES	18	WHT	#961 COURTESY LIGHT GROUND	HEADLIGHT SWITCH
YES	18	WHT	#961 COURTESY LIGHT GROUND	PASSENGER COURTESY LIGHT
YES	18	ORG	#971 COURTESY LIGHT POWER	FUSE BLOCK/ DOME FUSE
YES	18	ORG	#971 COURTESY LIGHT POWER	PASSENGER COURTESY LIGHT
YES	18	GRY	#930 PANEL LIGHT POWER	PANEL LIGHT SPLICE
YES	18	GRY	#930 RADIO BACKLIGHT/DIM POWER	RADIO

CONSOLE HARNESS

TO NEUTRAL SAFETY/CLUTCH SWITCH

PRINT	GAUGE	COLOR	PRINTED MESSAGE ON WIRE	STARTING POINT
YES	12	PUR/WHT	#919 START SIGNAL (FROM IGN. SW. TO N. SAFETY)	CONSOLE NSS CONNECTOR
YES	12	PUR	#919 START SIGNAL TO STARTER	CONSOLE NSS CONNECTOR

TO REVERSE SWITCH

PRINT	GAUGE	COLOR	PRINTED MESSAGE ON WIRE	STARTING POINT
YES	16	PNK	#958 REVERSE SWITCH POWER INPUT	CONSOLE REVERSE SWITCH CONNECTOR
YES	16	LTGRN	#956 REVERSE LIGHT POWER	CONSOLE REVERSE SWITCH CONNECTOR

TO CONSOLE

PRINT	GAUGE	COLOR	PRINTED MESSAGE ON WIRE	STARTING POINT
YES	18	WHT	#961 CONSOLE COURTESY LIGHT GROUND	CONSOLE COURTESY LIGHT
YES	18	ORG	#971 CONSOLE COURTESY LIGHT POWER	CONSOLE COURTESY LIGHT
YES	18	GRY	#930 GEAR IND. LIGHT POWER	GEAR INDICATOR LIGHT SPLICE

GROUND

PRINT	GAUGE	COLOR	PRINTED MESSAGE ON WIRE	STARTING POINT
YES	18	BLK	#969 GEAR IND. LIGHT GROUND	CONSOLE GEAR IND. LIGHT
YES	18	BLK	#969 GEAR IND. LIGHT GROUND	CONSOLE GEAR IND. LIGHT

GEAR INDICATOR LIGHT

PRINT	GAUGE	COLOR	PRINTED MESSAGE ON WIRE	STARTING POINT
NO	18	GRY	#930 GEAR IND. LIGHT POWER	GEAR INDICATOR LIGHT SPLICE
YES	18	BLK	#969 GEAR IND. LIGHT GROUND	GROUND

NEUTRAL SAFETY/CLUTCH SWITCH

PRINT	GAUGE	COLOR	PRINTED MESSAGE ON WIRE	STARTING POINT
YES	12	PUR/WHT	#919 START SIGNAL (FROM IGN. SW. TO N. SAFETY)	NSS/CLUTCH SWITCH CONNECTOR MATE
YES	12	PUR	#919 START SIGNAL TO STARTER	NSS/CLUTCH SWITCH CONNECTOR MATE

REVERSE SWITCH

PRINT	GAUGE	COLOR	PRINTED MESSAGE ON WIRE	STARTING POINT
YES	16	PNK	#958 REVERSE SWITCH POWER INPUT	REVERSE SWITCH CONNECTOR MATE
YES	16	LTGRN	#956 REVERSE LIGHT POWER	REVERSE SWITCH CONNECTOR MATE

GEAR INDICATOR LIGHT

PRINT	GAUGE	COLOR	PRINTED MESSAGE ON WIRE	STARTING POINT
YES	18	GRY	#930 GEAR IND. LIGHT POWER	GEAR INDICATOR LIGHT SPLICE
YES	18	BLK	#969 GEAR IND. LIGHT GROUND	GROUND

CONSOLE COURTESY LIGHT

PRINT	GAUGE	COLOR	PRINTED MESSAGE ON WIRE	STARTING POINT
YES	18	WHT	#961 CONSOLE COURTESY LIGHT GROUND	TO CONSOLE CONNECTOR
YES	18	ORG	#971 CONSOLE COURTESY LIGHT POWER	TO CONSOLE CONNECTOR

INTERIOR HARNESS (continued)

GROUND

PRINT	GAUGE	COLOR	PRINTED MESSAGE ON WIRE	STARTING POINT
YES	12	BLK	#969 GROUND	INTERIOR GROUND SPLICE
YES	12	BLK	#969 GROUND	INTERIOR GROUND SPLICE

AFTERMARKET GAUGES

PRINT	GAUGE	COLOR	PRINTED MESSAGE ON WIRE	STARTING POINT
YES	16	BLK	#969 GROUND	INTERIOR GROUND SPLICE
NO	18	BLK	<i>#969 GROUND</i>	AFTER MARKET GAUGE CONNECTOR
YES	18	GRY	#930 AFTERMARKET GAUGE LIGHT POWER	PANEL LIGHT SPLICE
YES	18	PNK	#935 GAUGE POWER	GAUGE CLUSTER
YES	18	TAN	#939 FUEL LEVEL SIGNAL	GAUGE CLUSTER
YES	18	GRN	#921 COOLANT TEMPERATURE SIGNAL	GAUGE CLUSTER
YES	18	BRN	#923 TACH SIGNAL	GAUGE CLUSTER
YES	16	BLU	#922 OIL PRESSURE SIGNAL	GAUGE CLUSTER

HEATER SWITCH

PRINT	GAUGE	COLOR	PRINTED MESSAGE ON WIRE	STARTING POINT
YES	14	BRN	#904 HEATER/AC SWITCH POWER	FUSE BLOCK/ AC/HEAT FUSE
YES	14	ORG	#967 BLOWER MOTOR POWER	INTERIOR BULKHEAD

HEATER HARNESS

BLOWER SWITCH

PRINT	GAUGE	COLOR	PRINTED MESSAGE ON WIRE	STARTING POINT
NO	14	BRN	<i>#904 HEATER/AC SWITCH POWER</i>	HEATER SWITCH MATE
NO	14	ORG	<i>#967 BLOWER MOTOR POWER</i>	HEATER SWITCH MATE
YES	14	ORG	#973 BLOWER MOTOR HIGH	BLOWER RESISTOR
YES	14	YLW	#975 BLOWER MOTOR LOW	BLOWER RESISTOR
YES	14	LTBLU	#974 BLOWER MOTOR MEDIUM	BLOWER RESISTOR

HEATER RESISTOR

PRINT	GAUGE	COLOR	PRINTED MESSAGE ON WIRE	STARTING POINT
YES	14	ORG	#973 BLOWER MOTOR HIGH	BLOWER SWITCH
YES	14	YLW	#975 BLOWER MOTOR LOW	BLOWER SWITCH
YES	14	LTBLU	#974 BLOWER MOTOR MEDIUM	BLOWER SWITCH

INTERIOR HARNESS (continued)

HEATER SWITCH INDICATOR LIGHT

PRINT	GAUGE	COLOR	PRINTED MESSAGE ON WIRE	STARTING POINT
YES	18	GRY	#930 PANEL LIGHT POWER	PANEL LIGHT SPLICE
YES	18	BLK	#969 GROUND	INTERIOR GROUND SPLICE

PASSENGER COURTESY LIGHT

PRINT	GAUGE	COLOR	PRINTED MESSAGE ON WIRE	STARTING POINT
YES	18	ORG	#971 COURTESY LIGHT POWER	CONSOLE CONNECTOR
YES	18	ORG	#971 COURTESY LIGHT POWER	GLOVE BOX
YES	18	WHT	#961 COURTESY LIGHT GROUND	CONSOLE CONNECTOR
YES	18	WHT	#961 PASS. DOOR JAMB SWITCH	PASS. DOOR JAMB SWITCH

GLOVE BOX

PRINT	GAUGE	COLOR	PRINTED MESSAGE ON WIRE	STARTING POINT
YES	18	ORG	#971 COURTESY LIGHT POWER	PASS. COURTESY LIGHT

PASSENGER JAMB SWITCH

PRINT	GAUGE	COLOR	PRINTED MESSAGE ON WIRE	STARTING POINT
YES	18	WHT	#961 PASS. DOOR JAMB SWITCH	PASS. COURTESY LIGHT

WIPER SWITCH

PRINT	GAUGE	COLOR	PRINTED MESSAGE ON WIRE	STARTING POINT
YES	18	BLU	#984 WASHER PUMP GROUND	INTERIOR BULKHEAD
YES	18	BLK	#979 WIPER MOTOR (LOW/PARK)	INTERIOR BULKHEAD
YES	18	LTBLU	#977 WIPER MOTOR (HIGH)	INTERIOR BULKHEAD
YES	18	BLK	#969 WIPER GROUND	INTERIOR GROUND SPLICE

HEADLIGHT SWITCH

PRINT	GAUGE	COLOR	PRINTED MESSAGE ON WIRE	STARTING POINT
YES	18	WHT	#961 COURTESY LIGHT GROUND	DRIVER COURTESY LIGHT
YES	18	WHT	#961 COURTESY LIGHT GROUND	CONSOLE CONNECTOR
YES	14	RED	#928 HEADLIGHT SWITCH POWER (HEADLIGHTS)	FUSE BLOCK/ HEADLIGHT FUSE
YES	16	GRN	#930 PANEL LIGHT POWER	PANEL LIGHT SPLICE
YES	14	LTBLU	#907 DIMMER SWITCH POWER	DIMMER SWITCH CONNECTOR
YES	16	BRN	#927 PARK LIGHT POWER	INTERIOR BULKHEAD
YES	16	BRN	#929 TAIL LIGHT POWER	TAIL HARNESS CONNECTOR
YES	14	ORG	#959 HEADLIGHT SWITCH POWER (PARK/TAIL)	FUSE BLOCK/ PARK-TAIL FUSE

GAUGE CLUSTER

PRINT	GAUGE	COLOR	PRINTED MESSAGE ON WIRE	STARTING POINT
YES	18	TAN	#968 BRAKE WARN SIGNAL	INTERIOR BULKHEAD
YES	18	GRY	#930 PANEL LIGHT POWER	PANEL LIGHT SPLICE
NO	18	GRY	<i>#930 PANEL LIGHT POWER</i>	GAUGE CLUSTER
YES	18	LT.BLU	#937 LEFT TURN INDICATOR	INTERIOR BULKHEAD
YES	18	BLU	#938 RIGHT TURN INDICATOR	INTERIOR BULKHEAD
YES	18	TAN	#939 FUEL LEVEL SIGNAL	TAIL HARNESS CONNECTOR
YES	18	TAN	#939 FUEL LEVEL SIGNAL	AFTERMARKET GAUGE CONNECTOR

GAUGE CLUSTER- continued

PRINT	GAUGE	COLOR	PRINTED MESSAGE ON WIRE	STARTING POINT
YES	18	ORG	#965 CLOCK POWER	FUSE BLOCK/ CIG LIGHTER FUSE
YES	18	GRN	#921 COOLANT TEMPERATURE SIGNAL	IGNITION SWITCH CONNECTOR
YES	18	GRN	#921 COOLANT TEMPERATURE SIGNAL	AFTERMARKET GAUGE CONNECTOR
YES	18	BLU	#922 OIL PRESSURE SIGNAL	INTERIOR BULKHEAD
YES	18	BLU	#922 OIL PRESSURE SIGNAL	AFTERMARKET GAUGE CONNECTOR
YES	18	BRN	#923 TACH SIGNAL	AFTERMARKET GAUGE CONNECTOR
YES	18	BRN	#923 TACH SIGNAL	INTERIOR BULKHEAD
YES	18	PNK	#935 GAUGE POWER	FUSE BLOCK/ GAUGES FUSE
YES	18	PNK	#935 GAUGE POWER	AFTERMARKET GAUGE CONNECTOR
YES	18	BLK	#969 GROUND	INTERIOR GROUND SPLICE
YES	16	BRN/WHT	#914 ALT. EXCITER/CHARGE INDICATOR	IGNITION SWITCH CONNECTOR
YES	16	BRN	#914 ALTERNATOR EXCITER	INTERIOR BULKHEAD
YES	18	LTGRN	#936 HIGH BEAM INDICATOR POWER	INTERIOR BULKHEAD

IGNITION SWITCH

PRINT	GAUGE	COLOR	PRINTED MESSAGE ON WIRE	STARTING POINT
YES	18	GRN	#921 COOLANT TEMPERATURE SIGNAL	GAUGE CLUSTER CONNECTOR
YES	18	GRN	#921 COOLANT TEMPERATURE SIGNAL	INTERIOR BULKHEAD
YES	16	PNK/BLK	#931 SWITCHED POWER TO "COIL" FUSE	FUSE BLOCK/ COIL FUSE
YES	12	RED	#934 IGNITION SWITCH POWER	FUSE BLOCK
YES	12	ORG	#933 SWITCHED (IGN) POWER TO FUSE BLOCK	FUSE BLOCK
YES	12	PUR/WHT	#919 START SIGNAL (FROM IGN. SW. TO N. SAFETY)	NEUTRAL SAFETY/CLUTCH SWITCH
YES	12	BRN	#932 SWITCHED ACCESSORY POWER	FUSE BLOCK
YES	16	BRN/WHT	#914 ALT. EXCITER/CHARGE INDICATOR	GAUGE CLUSTER CONNECTOR

CIGARETTE LIGHTER

PRINT	GAUGE	COLOR	PRINTED MESSAGE ON WIRE	STARTING POINT
YES	14	ORG	#903 CIGARETTE LIGHTER POWER	FUSE BLOCK/ CIG LIGHTER FUSE
YES	14	BLK	#969 GROUND	INTERIOR GROUND SPLICE

RADIO

PRINT	GAUGE	COLOR	PRINTED MESSAGE ON WIRE	STARTING POINT
YES	16	YLW	#940 RADIO BATTERY POWER (MEMORY)	FUSE BLOCK/ RADIO FUSE
YES	16	RED	#941 RADIO SWITCHED POWER	FUSE BLOCK/ RADIO FUSE
YES	18	GRY	#930 RADIO BACKLIGHT/DIM POWER	CONSOLE CONENCTOR
YES	18	BLK	#969 GROUND	INTERIOR GROUND SPLICE

TAIL SECTION CONNECTOR

PRINT	GAUGE	COLOR	PRINTED MESSAGE ON WIRE	STARTING POINT
YES	18	WHT	#961 DOME LIGHT GROUND	DRIVER DOOR JAMB SWITCH
YES	18	ORG	#971 DOME LIGHT POWER	DRIVER COURTESY LIGHT
YES	16	LTGRN	#956 REVERSE LIGHT POWER	REVERSE SWITCH CONNECTOR
YES	16	BRN	#929 TAIL LIGHT POWER	HEADLIGHT SWITCH CONNECTOR
YES	18	TAN	#939 FUEL LEVEL SIGNAL	GAUGE CLUSTER CONNECTOR
YES	16	YLW	#949 REAR LEFT TURN SIGNAL POWER	TURN SIGNAL SWITCH CONNECTOR
YES	16	GRN	#948 REAR RIGHT TURN SIGNAL POWER	TURN SIGNAL SWITCH CONNECTOR
YES	14	BLK	#969 GROUND	INTERIOR GROUND SPLICE

TAIL HARNESS

TAIL HARNESS CONNECTOR

PRINT	GAUGE	COLOR	PRINTED MESSAGE ON WIRE	STARTING POINT
YES	18	WHT	#961 DOME LIGHT GROUND	DOMELIGHT CONNECTOR
YES	18	ORG	#971 DOME LIGHT POWER	DOMELIGHT CONNECTOR
YES	16	LTGRN	#956 REVERSE LIGHT POWER	REVERSE LIGHT CONNECTOR
YES	16	BRN	#929 TAIL LIGHT POWER	TAIL LIGHT SPLICE
YES	18	TAN	#939 FUEL LEVEL SIGNAL	FUEL LEVEL SENDING UNIT
YES	16	YLW	#949 REAR LEFT TURN SIGNAL POWER	LEFT TURN-BRAKE-TAIL SOCKET
YES	16	GRN	#948 REAR RIGHT TURN SIGNAL POWER	RIGHT TURN-BRAKE-TAIL SOCKET
YES	14	BLK	#969 GROUND	TAIL HARNESS GROUND SPLICE

DOMELIGHT

PRINT	GAUGE	COLOR	PRINTED MESSAGE ON WIRE	STARTING POINT
YES	18	WHT	#961 DOME LIGHT GROUND	TAIL HARNESS CONNECTOR
YES	18	ORG	#971 DOME LIGHT POWER	TAIL HARNESS CONNECTOR
YES	18	ORG	#946 TRUNK LIGHT POWER	TRUNK LIGHT

TRUNK LIGHT

PRINT	GAUGE	COLOR	PRINTED MESSAGE ON WIRE	STARTING POINT
YES	18	ORG	#946 TRUNK LIGHT POWER	DOMELIGHT CONNECTOR

LEFT TURN/BRAKE/TAIL

PRINT	GAUGE	COLOR	PRINTED MESSAGE ON WIRE	STARTING POINT
YES	16	YLW	#949 REAR LEFT TURN/BRAKE SIGNAL POWER	TAIL HARNESS CONNECTOR
YES	18	BRN	#929 TAIL LIGHT POWER	TAIL LIGHT SPLICE

GROUND

PRINT	GAUGE	COLOR	PRINTED MESSAGE ON WIRE	STARTING POINT
YES	16	BLK	#969 GROUND	TAIL HARNESS GROUND SPLICE

REVERSE LIGHT

PRINT	GAUGE	COLOR	PRINTED MESSAGE ON WIRE	STARTING POINT
YES	16	LTGRN	#956 REVERSE LIGHT POWER	TAIL HARNESS CONNECTOR
YES	18	LTGRN	#956 REVERSE LIGHT POWER	PASS. REVERSE LIGHT

FUEL LEVEL

PRINT	GAUGE	COLOR	PRINTED MESSAGE ON WIRE	STARTING POINT
YES	18	TAN	#939 FUEL LEVEL SIGNAL	TAIL HARNESS CONNECTOR

PLATE LIGHT

PRINT	GAUGE	COLOR	PRINTED MESSAGE ON WIRE	STARTING POINT
YES	18	BRN	#929 PLATE LIGHT POWER	TAIL LIGHT SPLICE

REVERSE LIGHT

PRINT	GAUGE	COLOR	PRINTED MESSAGE ON WIRE	STARTING POINT
YES	18	LTGRN	#956 REVERSE LIGHT POWER	DRIVER. REVERSE LIGHT

GROUND

PRINT	GAUGE	COLOR	PRINTED MESSAGE ON WIRE	STARTING POINT
YES	14	BLK	#969 GROUND	TAIL HARNESS GROUND SPLICE

RIGHT TURN/BRAKE/TAIL

PRINT	GAUGE	COLOR	PRINTED MESSAGE ON WIRE	STARTING POINT
YES	16	GRN	#948 REAR RIGHT TURN SIGNAL POWER	TAIL HARNESS CONNECTOR
YES	18	BRN	#929 TAIL LIGHT POWER	TAIL LIGHT SPLICE

NOTES

Painless Performance Products, LLC **Limited Warranty and Return Policy**

Chassis harnesses, fuel injection harnesses, and Trail Rocker units are covered under a lifetime warranty.

All other products manufactured and/or sold by Painless Performance are warranted to the original purchaser to be free from defects in material and workmanship under normal use. Painless Performance will repair or replace defective products without charge during the first 12 months from the purchase date. No products will be considered for warranty without a copy of the purchase receipt showing the sellers name, address, and date of purchase. You must return the product to the dealer you purchased it from to initiate warranty procedures.

Painless Performance Products LLC
2501 Ludelle Street
Fort Worth, TX 76105
Phone (817) 244-6212

