

PAINLESS[®]

PERFORMANCE PRODUCTS



Off-Road Switch Panel

Installation Instructions

50340: 6 Switch Extreme Off-Road Switch Panel

w/ Keyed Ignition Switch

Painless Performance Products recommends you, the installer, read this installation manual from front to back before installing this harness.

Painless Performance Products, LLC

2501 Ludelle Street

Fort Worth, TX 76105-1036

800-423-9696 phone – 817-244-4024 fax

Web Site: www.painlessperformance.com

E-Mail: painless@painlessperformance.com

If you have any questions concerning the installation of this product, feel free to call **Painless Performance Products'** tech line at 1-800-423-9696. Calls are answered from 8am to 5pm central time, Monday thru Thursday, 8am-4:30pm Friday, except holidays.

Here we have provided you with accurate instructions for the installation of this product. However, if you have comments/suggestions concerning these instructions, please call or email us (our contact information can be found at the top of this page or online at **www.painlessperformance.com**). We sincerely appreciate your business.

Painless Performance Products, LLC shall in no event be liable in contract or tort (including negligence) for special, indirect, incidental, or consequential damages, such as but not limited to, loss of property, or any other damages, costs or expenses which might be claimed as the result of the use or failure of the goods sold hereby, except only the cost of repair or replacement.

Should you damage or lose part of your manual, a full-color copy of these instructions can be found online at www.painlessperformance.com

3rd Edition: Mar 2021

Copyright © 2019 by Perfect Performance Products, LLC

INSTALLATION

First, decide what switches will be used for your application and install them into the panel. Start by adjusting the hex shaped backing nut on each of the switches $\frac{3}{4}$ of the way back toward the body of the switch.

Insert the switch through the switch hole opening with the slot on the threads facing down and screw the black toggle switch boot onto the front of switch by hand until snug.

Next, using either a $\frac{5}{8}$ " or a 16mm deep wall socket hold the switch boot in place while tightening the hex shaped backing nut to fully secure the switch to the panel. Tightening the switch using the nut inside the switch boot could damage the shoulders around the boot.

In order to allow the maximum amount of room for the switch labels, line the switch boots up with the flat sides of the hex-shaped nut running parallel with the top and bottom sides of the switch panel.

Install the keyed ignition switch into the switch panel. Loosely tighten the retaining nut and then insert the key into the ignition switch cylinder. Tighten the weather-resistant retaining nut by hand using the key to properly align the switch. The key should face up and down in the off position. Next tighten the ignition switch backing nut to fully secure the ignition switch to the panel. **NOTE: A thread locker may be used to assist in keeping the ignition switch nut from vibrating loose.**

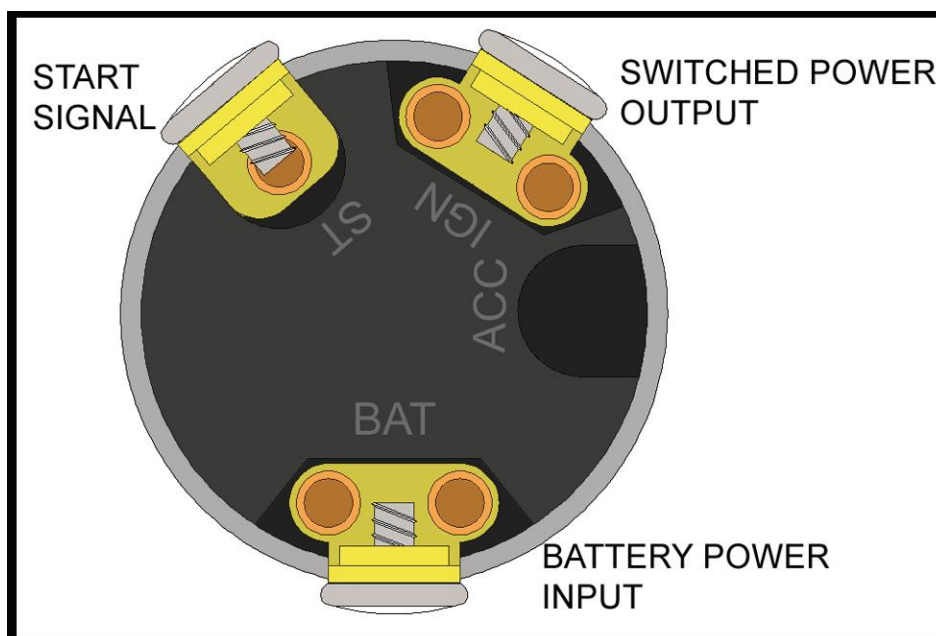
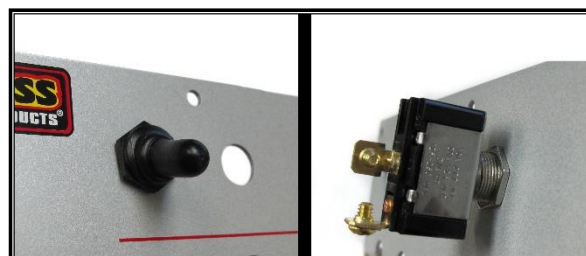

Illustration A, illustrates the proper hookup of wires to an on/off switch, which will control a single device.

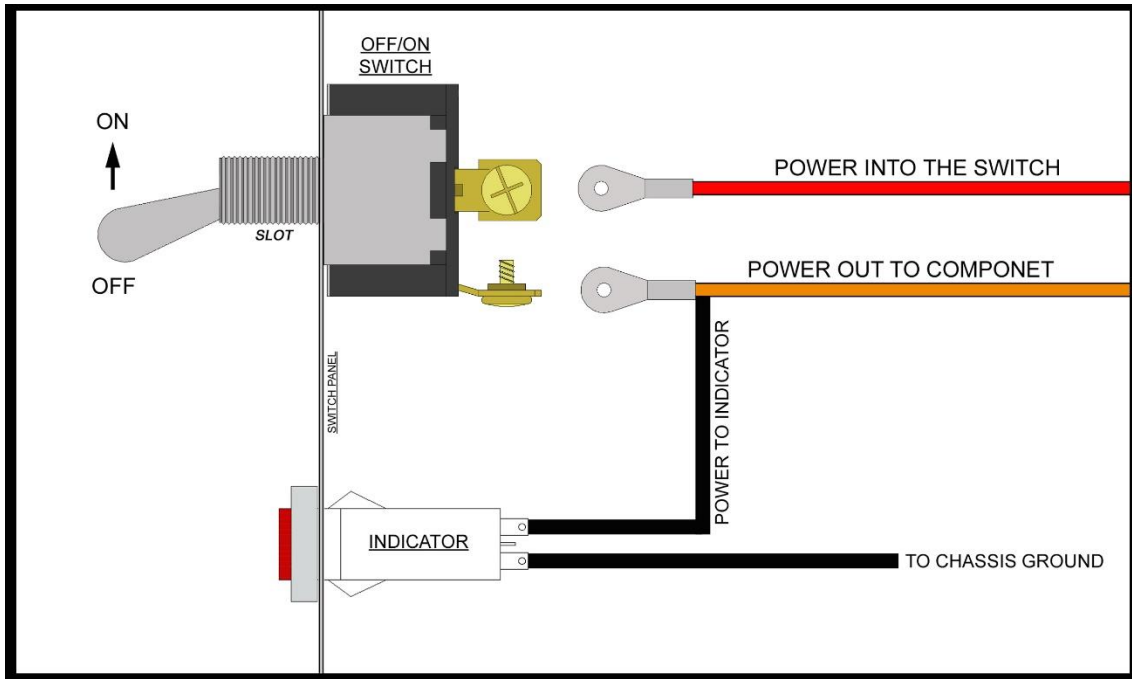

Illustration A

Illustration B, illustrates the proper hookup of wires to an on/off/on switch, which will control 2 separate devices.

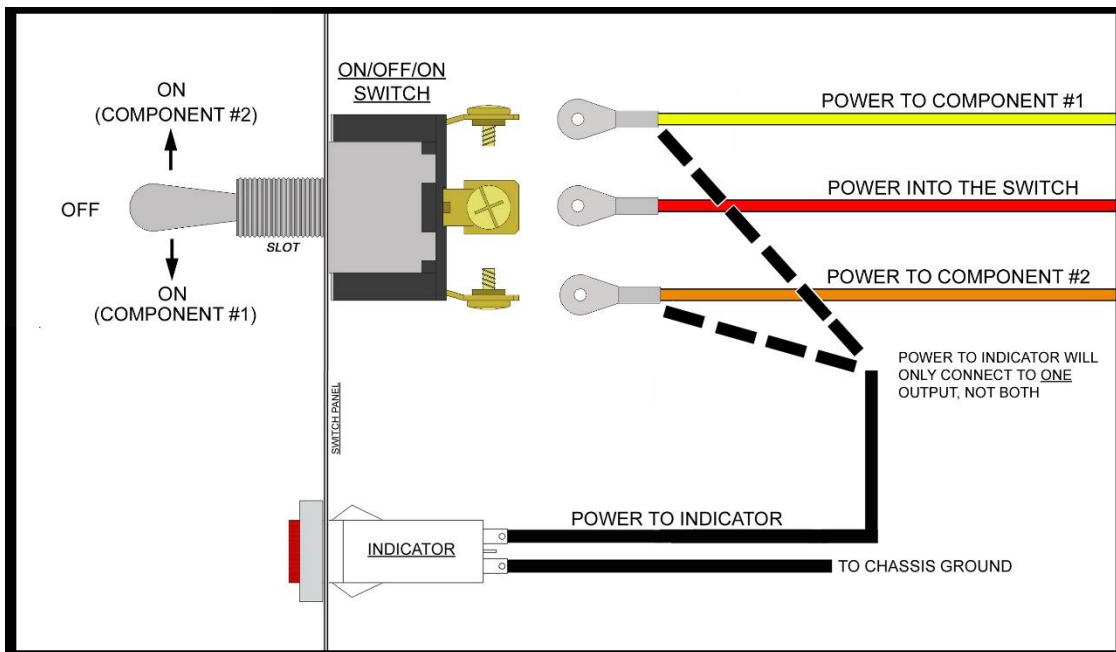

Illustration B

The power wire to the Indicator can only be connected to one of the Output wires. Connecting it to both Outputs will only tie the Outputs together causing power to be routed to both devices no matter which “on” position the switch is switched to. **Illustration C** shows the correct way to connect the Indicator to both Outputs using diodes.

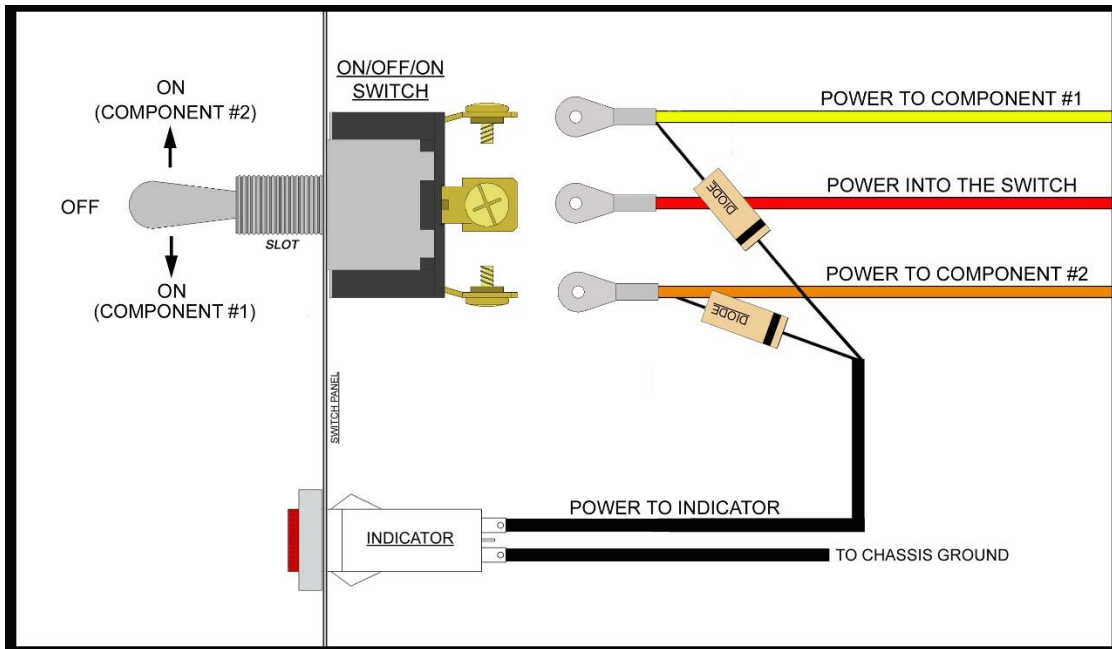

Illustration C

Illustration D illustrates the proper hookup of wires using an on/off/on switch when two devices are to be operated and one of the devices is to be on in both positions. An example might be headlights and taillights. With the switch in the upper position only the taillights are on and in the lower position the headlights and taillights are on. The diode, in the illustration, allows this function to take place.

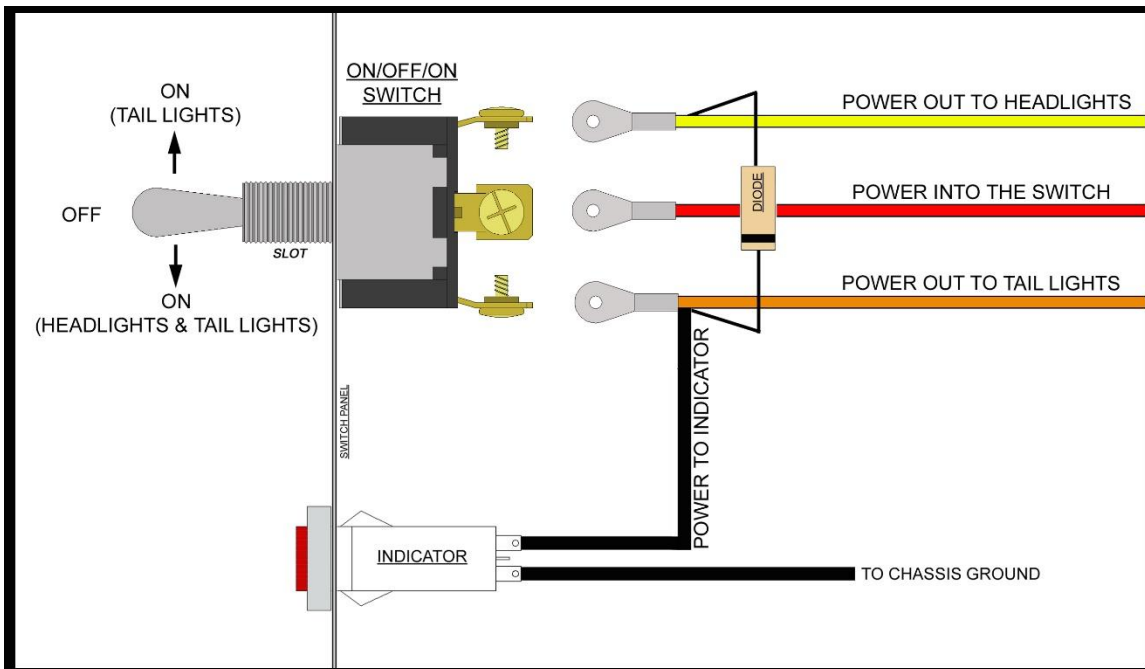

Illustration D

Once all of the wires have been connected to the switches, the polyethylene liner can be installed. Decide which hole of the roll bar mounting box the wires will be exiting and make a small hole in the liner. Then, pass the wires through the opening. Next, slide the liner over the switches and flush up to the panel.

Install the rubber grommet in the corresponding hole of the roll-bar mounting box and route the wires out that hole. Use the plastic plugs to fill the remaining holes. Secure the switch panel with the liner installed down onto the box with the six screws provided in this kit.

For dash mounted panels, you must cut a **9 3/4" x 2 1/4"** opening for the six switch panel to allow room for the polyethylene liner.

- The plastic wire ties are for looming and securing the wires to the vehicle.
- The label sheet included is to identify each switch of its function. Simply peel off the label needed and place it under the switch wired for that function. The "R" and "L" labels are for right and left in the event an on/off/on switch is turned sideways for turn signals

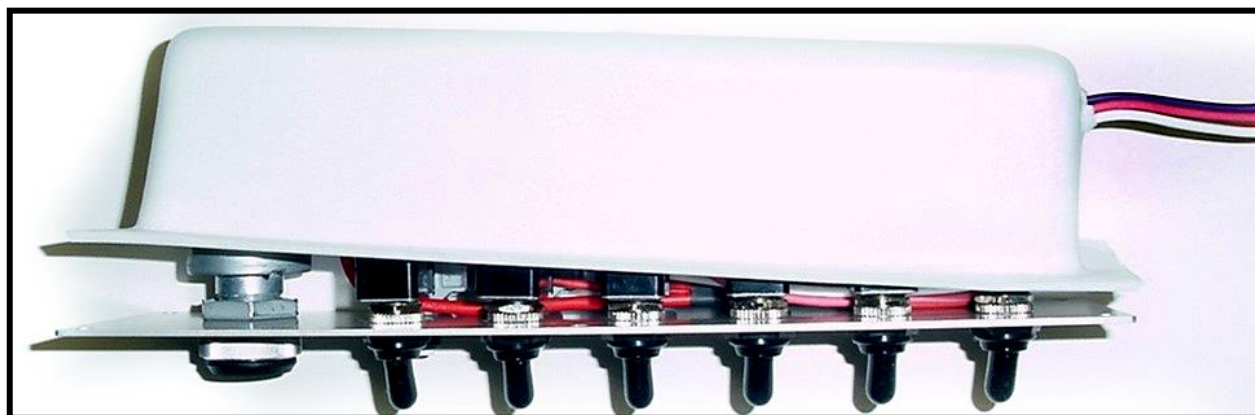

Painless Performance Products LLC **Limited Warranty and Return Policy**

Chassis harnesses, fuel injection harnesses, and switch panel units are covered under a lifetime warranty.

All other products manufactured and/or sold by Painless Performance are warranted to the original purchaser to be free from defects in material and workmanship under normal use. Painless Performance will repair or replace defective products without charge during the first 12 months from the purchase date. No products will be considered for warranty without a copy of the purchase receipt showing the sellers name, address and date of purchase. You must return the product to the dealer you purchased it from to initiate warranty procedures.

Painless Performance Products LLC
2501 Ludelle Street
Fort Worth, TX 76105
Phone (817) 244-6212