

PAINLESS

PERFORMANCE PRODUCTS

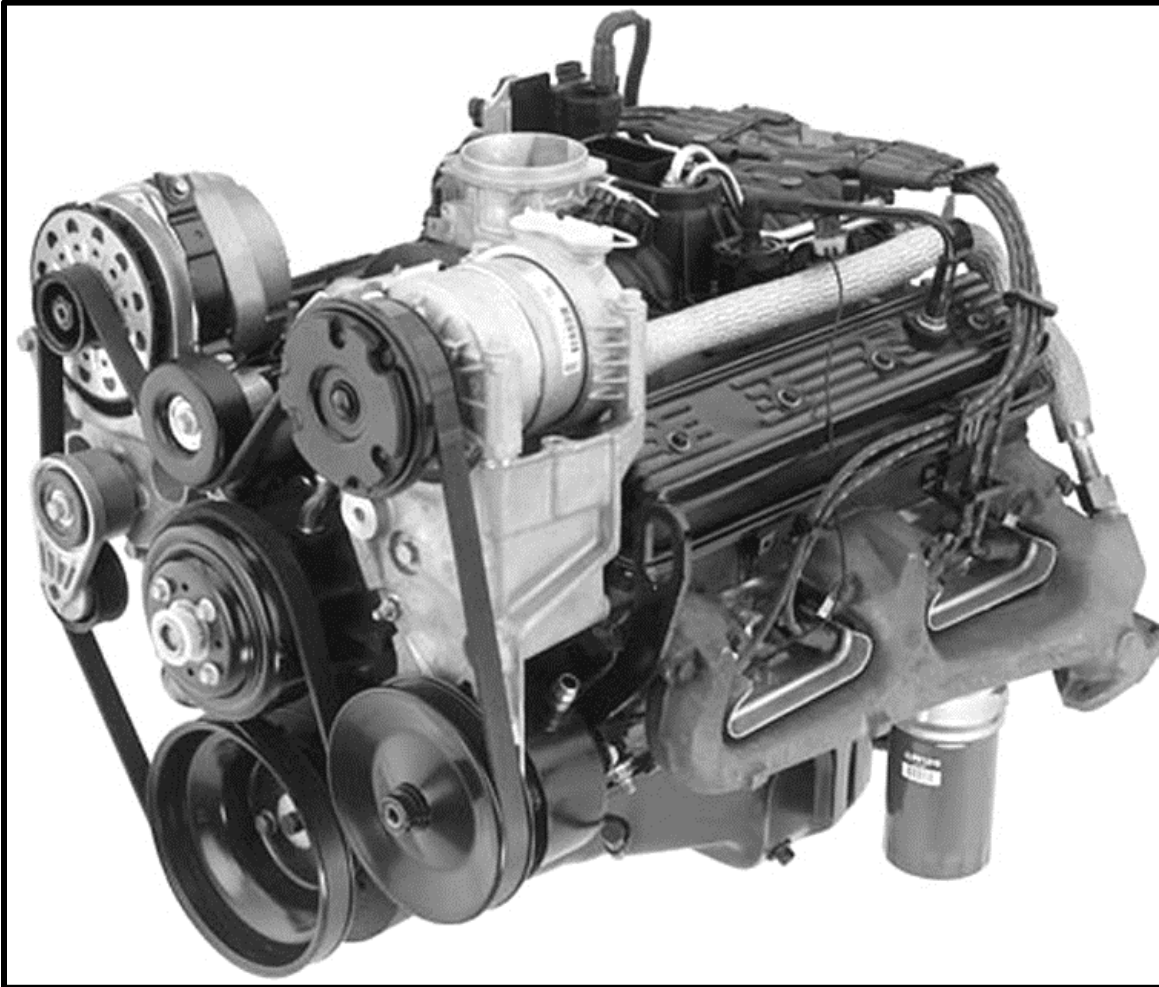

Wire Harness Installation Instructions

For Installing Harness Numbers:

60212: 96-99 GM Vortec 5.0 & 5.7L V8 (CMFI) Harness Std. Length

60213: 96-99 GM Vortec 5.0 & 5.7L V8 (CMFI) Harness Extra Length

60214: 96-99 GM Vortec 4.3L V6 (CMFI) Harness Std. Length

**60215: 96 - 99 GM Vortec V6 Fuel Injection Harness (CMFI) Extra
Length**

Manual P/N 90524

Painless Performance Products recommends you, the installer, read this installation manual from front to back before installing this harness.

Painless Performance Products, LLC
2501 Ludelle St.
Fort Worth, TX 76105-1036
PHONE: 800-423-9696 FAX: 817-244-4024
EMAIL: support@painlessperformance.com

If you have any questions concerning the installation of this harness, feel free to call Painless Performance Products' Tech Line at 1-800-423-9696. The Tech Line can be reached from 8 A.M. to 5 P.M. central time, Monday through Thursday, and 8 A.M. to 4:30 P.M. on Fridays.

We have attempted to provide you with as accurate of instructions as possible and are always concerned about corrections or improvements that can be made. If you have found any issues or omissions, or simply have comments or suggestions concerning these instructions, please write us at the above address, send us a fax at (817) 244-4024, or email us at support@painlessperformance.com. We sincerely appreciate your business.

Painless Performance Products, LLC shall in no event be liable in contract or tort (including negligence) for special, indirect, incidental, or consequential damages, such as but not limited to, loss of property damage, or any other damages, costs or expenses which might be claimed as the result of the use or failure of the goods sold hereby, except only the cost of repair or replacement.

4th Edition: November 2019
Copyright © 2019 by Painless Performance Products, LLC

CAUTION: BEFORE THE REMOVAL OF YOUR ORIGINAL HARNESS AND/OR THE INSTALL OF YOUR NEW PAINLESS HARNESS, DISCONNECT THE POWER FROM YOUR VEHICLE BY REMOVING THE NEGATIVE OR POSITIVE BATTERY CABLE FROM THE BATTERY.

TABLE OF CONTENTS

<u>PAGE #</u>	<u>SECTION</u>
5	1. <u>INTRODUCTION</u>
5	2. <u>ABOUT THESE INSTRUCTIONS</u>
6	3. <u>TOOLS NEEDED</u>
6	4. <u>PRE-INSTALLATION AND HARNESS ROUTING GUIDELINES</u>
6	4.1 TRANSMISSION FUNCTION
7	4.2 GET TO KNOW THE ENGINE THAT YOU ARE USING
8	5. <u>GENERAL INSTALLATION INSTRUCTIONS</u>
9	5.1 GROUNDING THE VEHICLE
9	5.2 ROUGH INSTALLATION
9	5.3 HARNESS ATTACHMENT
10	5.4 TERMINAL INSTALLATION INSTRUCTIONS
11	6. <u>INSTALLATION</u>
11	6.1 KIT CONTENTS
11	6.2 SPECIFIC CIRCUIT CONNECTIONS
13	6.3 ENGINE GROUP INSTALLATION
17	6.4 TAIL SECTION INSTALLATION
19	6.5 CONVERTING 4L60E TRANSMISSION CONN TO WORK W/ A 4M80E
20	7. <u>TROUBLE-SHOOTING INSTRUCTIONS</u>
20	7.1 THE "CHECK ENGINE" LIGHT
20	7.2 RETRIEVING TROUBLE CODES FROM THE COMPUTER
21	7.3 TROUBLE SHOOTING GUIDE FOR YOUR PAINLESS PERFORMANCE HARNESS
22	7.4 WHEN TO CALL PAINLESS WIRING TECH LINE
23	<u>LIMITED WARRANTY AND RETURN POLICY</u>

LIST OF FIGURES

<u>PAGE #</u>	<u>SECTION</u>	<u>FIG. #</u>
11	DLC CONN & CHECK ENG LIGHT	6.1
12	BRAKE SWITCH CONNCTION	6.2
12	BRAKE SWITCH RELAY	6.3
13	CANISTER VENT SOLENOID	6.4
13	FUEL PUMP RELAY	6.5
15	EGR VALVE	6.6
15	KNOCK SENSOR CONN.	6.7
15	OXYGEN SENSOR	6.8
15	MAP SENSOR	6.9
15	CAM SENSOR (DIST.)	6.10
15	CPS SENSOR	6.11
16	INJECTOR 1 – 8	6.12
16	COIL DRIVER	6.13
16	TPS SENSOR	6.14

Continued...

LIST OF FIGURES

<u>PAGE #</u>	<u>SECTION</u>	<u>FIG. #</u>
16	IAC VLAVE	6.15
16	MAF SENSOR	6.16
16	IGNITION COIL	6.17
17	CANISTER PURGE SOLENOID	6.18
17	ECT SENSOR	6.19
17	IAT SENSOR	6.20
17	FUEL PUMP/OIL PRESSURE SWITCH	6.21
18	VSS (4L60E)	6.22
18	A/T INPUT SPEED & VSS SENSOR, TRANSMISSION CONN. (4L80E)	6.23
18	TRANSMISSION CONN. (4L60E)	6.24
19	TRANSMISSION CONN. PIN-OUT	6.25
20	FUSE IDENTIFICATION	6.26

LIST OF TABLES

<u>PAGE #</u>	<u>SECTION</u>	<u>TABLE #</u>
7	COMPATIBLE PARTS FOR V8 ENG	4.1
8	COMPATIBLE PARTS FOR V6 ENG	4.2
13	DASH SECTION CONNECTIONS	6.1
14	ENGINE SECTION CONNECTIONS	6.2
13	INJECTOR WIRE COLORS	6.3
18	TAIL SECTION CONNECTIONS	6.4

1. INTRODUCTION

You have purchased what we at Painless Performance Products believe to be the most up-to-date and easiest-to-install automotive fuel injection harness on the market. It is designed for easy installation, even if you have no electrical experience.

This harness is designed to be a complete wiring system for the fuel injection system on General Motors 1996-99 Vortec injected 4.3L, 5.0L and 5.7L. Also, to control the 4L60E automatic or 4L80E transmission using the 1997 computer Service #16229684 for V8 and #16244210 for V6. This includes all wiring that is needed by the computer to run and control the injection system and transmission. This harness will get the Vortec engine and transmission up and operating but it is recommended that you also have the computer reprogrammed to remove anything in the original factory programming that relates to a device or devices that are not being used in your particular vehicle.

NOTE: Most likely the check engine light will come on and stay on when using a computer with the original factory programming this is normal and is why we recommended that the computer be reprogrammed.

NOTE: Most remanufactured computers come without any programming in them and must be programmed before they can be used.

NOTE: The program in your computer must match the transmission that you plan on using either the 4L60E or 4L80E.

Usually, the computer, relays and fuse block can easily be mounted under the dash. Most of the wiring in the harness has been pre-terminated to the proper connector and all wire has been GM color-coded. All wiring is TXL, 600 volt, and 125 degree centigrade with cross-link insulation.

This fuel injection system harness has been divided into three major groups:

ENGINE GROUP Includes wiring for the fuel injectors, ignition system, and sensors.

DASH GROUP Includes ignition feed wire, assembly line diagnostic link (DLC) connector, check engine light, computer connectors, brake switch wiring, tachometer wiring, VSS Signal wire, canister vent, fuse block, fuel pump relay connector.

TAIL GROUP Include VSS wiring, transmission wiring and power wire for fuel pump.

2. ABOUT THESE INSTRUCTIONS

These instructions provide information for the installation of the 60212 & 60213 Vortec Fuel Injection Harness Kit. The contents of these instructions are divided into major **Sections**, as follows:

- 1.0 INTRODUCTION
- 2.0 ABOUT THESE INSTRUCTIONS
- 3.0 TOOLS NEEDED
- 4.0 PRE-INSTALLATION AND HARNESS ROUTING GUIDELINES
- 5.0 GENERAL INSTALLATION INSTRUCTIONS
- 6.0 60212 VORTEC FUEL INJECTION HARNESS KIT
- 8.0 TROUBLE-SHOOTING INSTRUCTIONS AND TROUBLE CODES

Sections are further divided into **Paragraphs** and **Steps**. Throughout, the **Figure** numbers refer to illustration and the **Table** numbers refer to information in table form. These are located in or near the sections or paragraphs to which they correspond. Always pay careful attention to any notes or any text labeled **CAUTION**.

3. TOOLS NEEDED

In addition to your regular tools, you will need, at least, the following:

1. Crimping tool
 2. Wire stripper
 3. Continuity tester
 4. Electric drill
 5. 1 5/8" Hole saw
- NOTE: USE A QUALITY TOOL TO AVOID OVER-CRIMPING.**
- CAUTION: DO NOT USE A TEST LIGHT TO TEST THE COMPUTER OR SENSOR WIRING OR YOU WILL DAMAGE THE COMPUTER.**
- (FOR THE RUBBER GROMMET IN THE FIREWALL)**

4. PRE-INSTALLATION AND HARNESS ROUTING GUIDELINES

The installation of your harness kit will consist of two parts:

- The physical routing, positioning, and securing of the harness, wire groups, and individual wires and connectors.
- The proper electrical connection of the individual circuits.

We cannot tell you how to route the harness in your automobile. That depends a great deal upon the particular make of the automobile and what extent you want to secure and conceal the harness. We do offer some general guidelines and routing practices starting in **Paragraph 5.3**, general installation instructions in **Section 5.0**, and precise instruction concerning the electrical connections you will have to make beginning in **Section 6.0**. To help you begin thinking through the installation of your wire harness, read the following sections:

4.1 TRANSMISSION FUNCTION

If you are using the 4L60E transmission, read **Paragraph 4.1.1**, If you are using the 4L80E read **Paragraph 4.1.2**, and see **NOTE** at the bottom of the page.

- 4.1.1** If you ARE going to use a **4L60E transmission**, tape off and store the input speed sensor connector. You must use the vehicle speed sensor (VSS), and the correct brake switch. These are necessary to make the transmission work correctly. The brake switch should be closed (electrically connected) when the brakes **ARE NOT** being applied and open (not electrically connected) when the brakes **ARE** being applied. This is the opposite of a standard brake light switch. If you are using a pressure brake switch, a **SPDT** relay must be installed to unlock the converter when the brakes are applied. The vehicle speed sensor lets the computer know how fast the wheels are turning.
- 4.1.2** If you are using the **4L80E transmission** proceed using the same steps above, however you will use the output speed sensor connector, it will be rolled up in the harness.

NOTE: Emission Devices

This harness has provisions for the emission devices. We have rolled up the canister vent wiring in the dash section and it may be left there if this item is not to be used. If you plan on using this item you will need to route the wires out to the engine compartment. Secure the wires to the main harness using the tie wraps supplied.

4.2 YOU SHOULD GET TO KNOW THE ENGINE YOU ARE USING:

NOTE: The 96- 98 Vortec engines had three to four oxygen sensors from the factory, but the harness has provisions for only two, one on the driver side and one on the passenger side of the engine. We removed the rear oxygen sensors since they originally were behind the catalytic converters and most people don't want to run more than two oxygen sensors. This system has four rectangular connectors at the computer. A #16229684 computer is required for proper operation.

- 4.2.1 PPPI recommends the use of the following parts. See **Table 4.1**. These will meet all requirements and are compatible with PPPI harnesses. The numbers given are GM and AC Delco part numbers. **You must use the computer listed on table 4.1 with our harness.**
- 4.2.2 Familiarize yourself with the harness by locating each of the harness groups and by looking at the connectors on the wire ends.
- 4.2.3 Decide where and how the computer, fuse block and relays will be mounted. PPPI wire harness kits are designed to mount either under the dash or in the kick panel on the right side. They must be no further apart than the wiring will allow (approx. 18 inches).
- 4.2.4 A good exercise is to lay out the wire harness on the floor beside your vehicle and identify all the connectors and wires.
- 4.2.5 You will want to route the harness through and around open areas. Inside edges provide extra protection from hazards and also provide places for tie wraps, clips and other support.
- 4.2.6 Route the harness away from sharp edges, exhaust pipes, and the hood, trunk and door hinges.
- 4.2.7 Plan where harness supports will be located. Use a support approximately every 6 inches unless the harness routes under the floor carpet.
- 4.2.8 Allow enough slack in the harness at places where movement could possibly occur (body to frame, frame to engine, etc.).
- 4.2.9 The wires should be bundled into harness groups. Use tape, nylon ties or poly split loom.

Vortec V8 Fuel Injection Harness (96 - 99) Part # 60212 & 60213

Main Computer	Service# 16229684	Idle Air Control Motor	Delco# 217-435
Fuel Pump Relay	Delco# D954A	Knock Sensor	Delco# 213-324
Brake Switch	Delco# D1565E	EGR Valve	Delco# 214-1038
Intake Air Temperature	Delco# 213-243	Coil	Delco# D577
MAF Sensor	Delco# 213-252	Cam Position Sensor	Delco# 213-920
Engine Coolant Temperature	Delco# 213-310	Crankshaft Position Sensor	Delco# 213-946
Oxygen Sensor (Pass. Side)	Delco# AFS105	Canister Purge Solenoid	Delco# 214-628
Oxygen Sensor (Drv. Side)	Delco# AFS105	Canister Vent Solenoid	GM# 12640448
TPS Sensor	Delco# 213-912	VSS (4L60E Only)	Delco# 213-328
MAP Sensor	Delco# 213-351	VSS (4L80E Only)	GM# 24203876
Ignition module	Delco# D579	Oil Pressure Switch	GM# 12553175

Table 4.1 Compatible Parts for V8 Engines

Vortec V6 Fuel Injection Harness (96 - 99) Part # 60214 & 60215

Main Computer	Service# 16244210	Idle Air Control Motor	Delco# 217-435
Fuel Pump Relay	Delco# D954A	Knock Sensor	Delco# 213-94
Brake Switch	Delco# D1565E	EGR Valve	Delco# 214-1038
Intake Air Temperature	Delco# 213-243	Coil	Delco# D577
MAF Sensor	Delco# 213-252	Cam Position Sensor	Delco# 213-920
Engine Coolant Temperature	Delco# 213-310	Crankshaft Position Sensor	Delco# 213-946
Oxygen Sensor (Pass. Side)	Delco# AFS105	Canister Purge Solenoid	Delco# 214-628
Oxygen Sensor (Drv. Side)	Delco# AFS105	Canister Vent Solenoid	GM# 15640448
TPS Sensor	Delco# 213-912	VSS (4L60E Only)	Delco# 213-328
MAP Sensor	Delco# 213-351	VSS (4L80E Only)	GM# 24203876
Ignition module	Delco# D579	Oil Pressure Switch	GM# 12553175

Table 4.2 Compatible Parts for V6 Engines

5. GENERAL INSTALLATION INSTRUCTIONS

CAUTION:

- **DO NOT DISCONNECT THE BATTERY OR THE COMPUTER CONNECTORS WHILE THE IGNITION IS ON.**
- **DO NOT SHORT ANY WIRES IN THIS HARNESS TO GROUND (WITH THE EXCEPTION OF LABELED GROUND WIRES) OR DAMAGE TO THE COMPUTER WILL RESULT.**
- **GIVING OR RECEIVING A "JUMP START" MAY DAMAGE THE COMPUTER.**
- **DO NOT USE A TEST LIGHT WHEN TESTING COMPUTER SENSORS OR COMPUTER CIRCUITS. DAMAGE TO THE COMPUTER WILL RESULT!**
- **WHEN ROUTING THE WIRES FOR THE VEHICLE SPEED SENSOR (IF USED) MAKE CERTAIN THAT THEY ARE AT LEAST 12 INCHES AWAY FROM ANY IGNITION WIRING (SPARK PLUG WIRES, ETC.).**

NOTES:

- There is a normal, small current drain on these fuel injected systems.
- Each connector in this harness is different and will not fit in the wrong place. **NEVER FORCE ANY CONNECTOR.**
- When connecting the plugs to the computer **USE EXTREME CARE** to make sure none of the pins in the computer are or become bent.
- The fuel pump and pressure regulator you are using **MUST** maintain a constant pressure of **55-60.**

PSI (pounds per square inch). The Vortec fuel system does not have a built-in regulator on the fuel rail as in many earlier GM fuel injection systems.

5.1 GROUNDING THE VEHICLE

A perfectly and beautifully wired automobile will nevertheless have problems if everything is not properly grounded. Don't go to the effort to installing a quality wire harness only to neglect proper grounding.

Note: The installer of this harness is responsible for all ground wires not provided with this part.

- 5.1.1 Connect a ground strap or cable (minimum of a 4 Ga. wire) from the negative battery terminal to the chassis (frame).
- 5.1.2 Connect a ground strap (minimum of a 4 Ga. wire) from the engine to the chassis (frame). **DO NOT RELY UPON THE MOTOR MOUNTS TO MAKE THIS CONNECTION.**
- 5.1.3 Connect a ground strap from the engine to the body.

5.2 ROUGH INSTALLATION

CAUTION: DISCONNECT THE POWER FROM YOUR VEHICLE BY REMOVING THE NEGATIVE BATTERY CABLE FROM THE BATTERY.

Note: Make no wire connections or permanent mounting of any kind at this time.

- 5.2.1 Position the computer and sensors in their intend locations.
- 5.2.2 Drill a 1-5/8" hole for the firewall grommet near the computer for the engine group and tail section to pass through.
- 5.2.3 Route the engine group and tail section through the hole. Push the grommet (already installed on the harness) into the hole until it is seated.
- 5.2.4 Route the dash group over to the driver's side of the car.
- 5.2.5 Route the fuse block and relays to the place they will be mounted.

5.3 HARNESS ATTACHMENT

Note: Harness routing and shaping will be a time-consuming task. Taking your time will enhance the beauty of your vehicle. Please take your time and be patient.

- 5.3.1 Permanently mount your computer. You should mount the fuse block and relays at this time.
- 5.3.2 Mold harness groups to the contour of the dash, engine, frame, etc. Remember to route harness away from sharp edges, exhaust pipes, hinges, and moving parts.
- 5.3.3 Attach harness groups to your automobile with clips or ties starting at the computer and working your way outward.

Note: Do not tighten tie wraps or mounting devices at this time. Make all harness attachments LOOSELY.

- 5.3.4 When used every 1-1/2" or so on the visible areas of the harness, colored plastic wire ties make a very attractive assembly. Otherwise, a tie installed in other areas every 6" or so will hold the wires in place securely. **REMEMBER TO TAKE YOUR TIME.**

5.4 TERMINAL INSTALLATION INSTRUCTION

Note: In the following steps you will be making the circuit connections. Before you start, you should carefully read Sections 6.0, and continually refer to the wire charts, **DOUBLE CHECKING** your length calculations before cutting any wire or making any connections. These directions are for the wires, which do not have a connector already, installed on them.

5.4.1 Have all tools and connectors handy.

5.4.2 Select the correct terminal for the wire and application.

5.4.3 Determine the correct wire length and cut the wire. Remember to allow enough slack in the harness and wires at places where movement could occur. **DOUBLE CHECK YOUR CALCULATIONS.**

5.4.4 Strip insulation away from wire. Only strip as much insulation off as necessary for the type of terminal lug you are using.

Note: In the following step, make sure that the terminal is crimped with proper die in the crimping tool. An improper crimp will not make a good connection. **DO NOT OVER-CRIMP.**

5.4.5 Crimp the terminal onto the wire.

5.4.6 Connecting the wires and connectors throughout the harness is a simple process. Make sure that each wire is properly routed and then attached. **DO NOT ATTACH THEN ROUTE AFTERWARD.**

5.4.7 When all the wires are attached, tighten the mounts and ties to secure the harness permanently.

5.4.8 Attach the connectors to the computer. **BEING VERY CAREFUL NOT TO BEND ANY PINS.**

5.4.9 After all connections have been made throughout the harness, connect the battery to the vehicle.

CAUTION: **BE SURE THE IGNITION IS OFF WHEN YOU RECONNECT THE BATTERY OR YOU WILL DAMAGE THE COMPUTER.**

6.0 INSTALLATION

6.1 KIT CONTENTS

Take inventory to see that you have everything you are supposed to have in this kit. If anything is missing, contact the dealer where you obtained the kit or contact Painless Performance at (817) 244-6898. The kit should contain the following items:

- The main wire harness with the connectors already on the ends of most of the wires.
- Fuel Injection Installation Instructions **P/N 90524** (This Booklet).
- 4" & 7" tie wraps.

6.2 SPECIFIC CIRCUIT CONNECTIONS

Note: If you have not already done so, read sections 4.0 and 5.0 of these instructions and think through the installation of the harness before securing or cutting any wires.

6.2.1 DASH SECTION INSTALLATION

The wires in this group consist of the diagnostic link connector (DLC) (SEE **FIGURE 6.1**), the check engine light (pre-mounted into a mounting bracket), fuse block w/ fuses and relays, fuel pump relay connector/w relay and 7 other wires.

NOTE: You may need to connect the check engine light wires to their mates in the wire harness.

CAUTION: DO NOT MAKE ANY CONNECTIONS WHILE THE COMPUTER IS PLUGGED INTO THE HARNESS.

NOTE: Wire color (Example: BLK/**WHT**) is one wire with a stripe. The second color (the stripe) may not be bold. Observe all two-color wires closely.

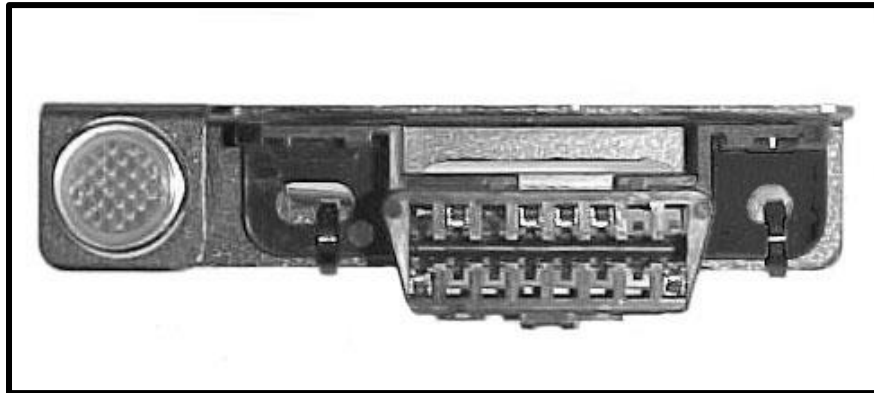

FIGURE 6.1 DLC Connector & Check Engine Light

- A. Find a suitable location to mount the DLC connector (using the bracket that the light is mounted in) that will allow access to the front of the connector and still allow you to see the light while driving.
- B. Mount the DLC connector using the bracket containing the check engine light in the place selected.

- C. Locate the white ignition hot activation wire, labeled FUSE BLOCK IGNITION (18 Ga.) and attach it to a 12V **fused** power source where there is power **WHEN THE KEY IS IN THE START AND RUN POSITION**. This wire activates the relays that supply power to all the ignition hot circuits in the fuel injection harness. If the white wire is connected correctly, the check engine light will come on when the ignition switch is in the "ON and START" position.
- D. The purple and brown wires labeled BRAKE SWITCH are the wires that connect to the brake switch to let the computer know when the brake is applied. If you **ARE NOT** using a 4L60E or 4L80E then you will tape off and store these wires. If you **ARE** using the 4L60E or 4L80E transmission then you will have to install an electrical switch described in **Paragraph 4.1.2**. The brown wire provides power for this switch and the purple wire is the signal going to the computer.
- E. If you are using the recommended brake switch then you will wire it according to **Figure 6.2**. The brown wire to the back of the switch in the illustration is the wire that has power on it whether or not the brake is being applied.

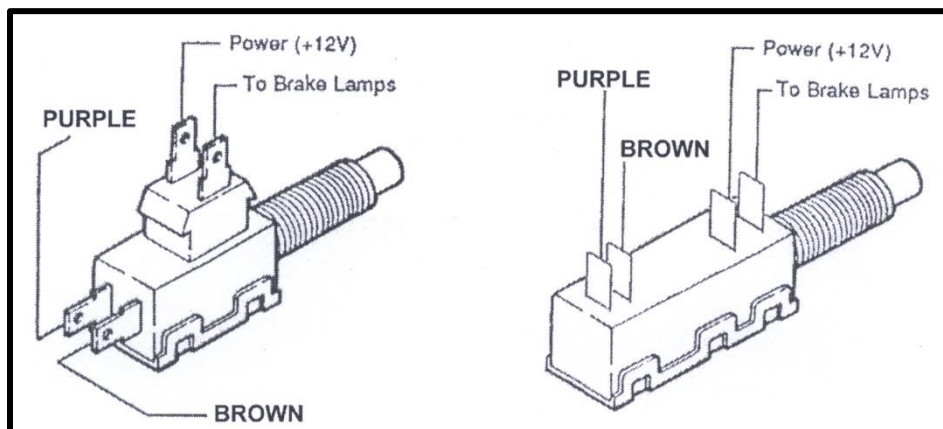

FIGURE 6.2 Brake Switch Connection

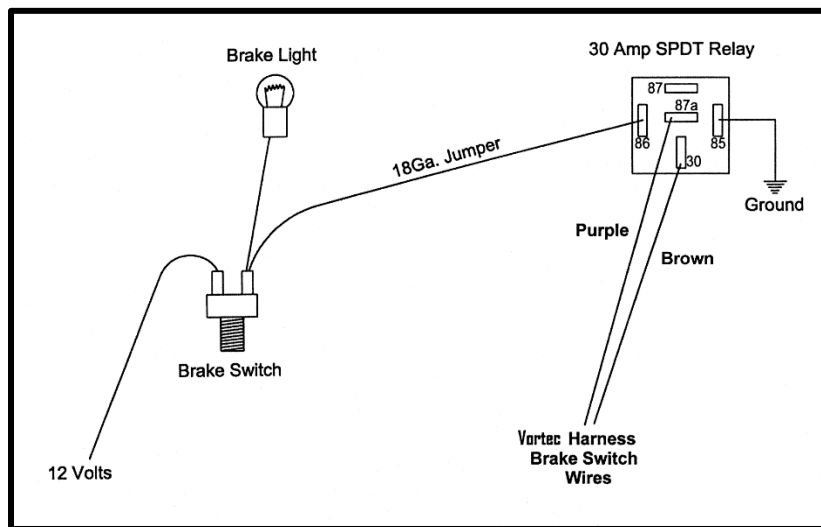

FIGURE 6.3 Brake Switch Relay

CAUTION: FAILURE TO WIRE THIS SWITCH CORRECTLY WILL RESULT IN A DANGEROUS SITUATION ON THE VEHICLE.

- F. If your vehicle has a pressure type brake switch, you may use a relay as shown in **Figure 6.3**. The relay must be a **SPDT Relay** and wired correctly or it could result in a dangerous situation with the vehicle. The torque **converter may not unlock**.

The wire labeled FUEL TEST is a test point for the fuel pump. After the vehicle has been wired and tested OK, tape off this wire and store it in the harness.

- G. The wire labeled TACH (white) is the signal wire for a tachometer if used.
- H. The VSS output wire (green) sends out a signal to operate the electronic cruise control or speedometer if so equipped.

6.2.2 DASH SECTION CONNECTIONS

WIRE COLOR	# OF POSITIONS IN CONNECTOR	LABELED	CONNECT TO:
1. PINK, GRN/WHT	2	Canister Purge	Canister Purge Solenoid
2. BRN, BRN/WHT	2	Canister Vent	Canister Vent Solenoid
3. GRAY, GRN/WHT, BLK/WHT, ORG, RED	5	Fuel Relay	Fuel Pump Relay
4. GREEN		VSS Output	Speedometer
5. WHITE		Tach	Tachometer
6. PURPLE, BROWN		Brake Switch	Brake Switch
7. WHITE		Fuse Block Ignition	Ignition Power

TABLE 6.1 Dash Section Connections



FIGURE 6.4 Canister vent solenoid

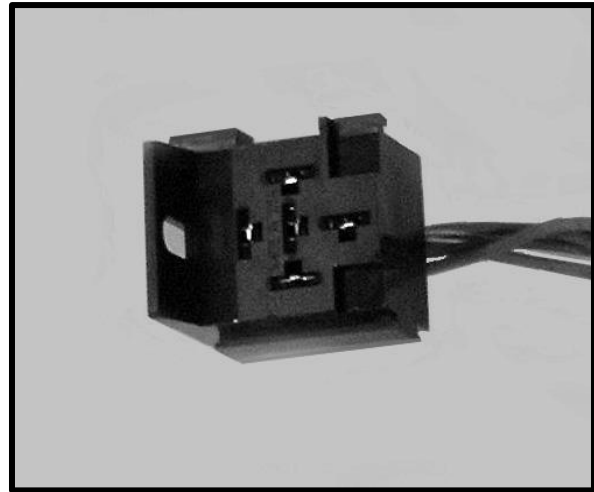

FIGURE 6.5 Fuel Pump Relay

6.3 ENGINE GROUP INSTALLATION

The engine group is designed to be separated into left side (driver) and right side (passenger) sections. Each side is tie-wrapped separately, **BUT NOT LABELED**. The left side of the engine has the connectors for the idle air control and throttle position sensor, all of which **ARE** labeled. When you begin routing, **FIRST** separate the engine group into left and right sections and place them accordingly.

- 6.3.1 Before you connect any wires, separate the tail section from the engine group and place it out of the way.
- 6.3.2 Connect the two ring terminals labeled STARTER B+ with Red wires to the large battery terminal on the starter solenoid.
- 6.3.3 Locate the two large ring terminals with **BLACK** and **BLK/WHT** wires and ground them to the engine.

6.3.4 Using **Figure 6.6-6.24**, and the specific connections indicated in **Table 6.2**, connect the wiring as directed.

NOTE: The canister vent solenoid connector is rolled up in the dash section and must be routed out to the engine compartment if these items are to be used.

6.3.5 Engine Section Connections

<u>WIRE COLOR</u>	<u># OF POSITIONS IN CONNECTOR</u>	<u>LABELED</u>	<u>CONNECT TO:</u>
BLACK, BROWN, PINK, GRAY, GRAY/BLACK	5	EGR	EGR Valve
BLUE	1	Knock	Knock Sensor Conn.
TAN/WHITE, PURPLE/WHITE, BLACK, PINK	4	O2 Sensor	Driver Side Oxygen Sensor
TAN, PURPLE, BLACK, PINK	4	O2 Sensor	Pass. Side Oxygen Sensor
BLACK, LT. GREEN, GRAY	3	MAP	MAP Sensor
BROWN/WHITE, PINK, PINK/BLACK	3	Dist.	CAM Position Sensor
YELLOW, PURPLE, PINK	3	CPS	Crankshaft Position Sensor
NOTE: See next page for Injector Wire Colors	16 12	Injector V8 Injector V6	Central Port Injector Central Port Injector
BLACK, BLUE, GREY	3	TPS	Throttle Position Sensor
PINK, YELLOW, BLACK/WHITE	3	MAF	Mass Airflow Sensor
YELLOW, BLACK	2	ECT	Engine Coolant Temp Sensor
TAN, BLACK	2	IAT	Intake Air Temp Sensor
LT. GREEN/BLACK, LT. BLUE/BLACK, LT. BLUE/WHITE, LT. GREEN/WHITE	4	IAC	Idle Air Control Module
PINK, WHITE, BLACK/WHITE, WHITE/BLACK	4	Coil Driver	Coil Driver Conn
PINK, WHITE, WHITE/BLACK	3	Coil	Coil Conn.
BLACK/WHITE, BLACK		Ground	Engine Ground
RED (2)		Starter B+	Starter Solenoid Batt. Terminal

TABLE 6.2 Engine Section Connections

NOTE: THE 4.3L WILL USE THE SAME COLOR WIRES AS THE 5.0L AND 5.7L ENGINES.	
Black	Injector #1
Lt. Green/Black	Injector #2 5.0L, 5.7L
Pink/Black	Injector #3 4.3L
Yellow/Black	Injector #6 5.0L, 5.7L
Black/White	Injector #5 4.3L
Lt. Blue/Black	Injector #4 5.0L, 5.7L
Red/Black	Injector #7 5.0L, 5.7L
Yellow/Black	Injector #6 4.3L
Blue/White	Injector #8 5.0L, 5.7L
Lt. Green/Black	Injector #2 4.3L
Black/White	Injector #5 5.0L, 5.7L
Lt. Blue/Black	Injector #4 4.3L
Pink/Black	Injector #3 5.0L, 5.7L

TABLE 6.3 Injector Section Conn

NOTE: Some locations of connectors on the 7.4 will differ from the figures shown.

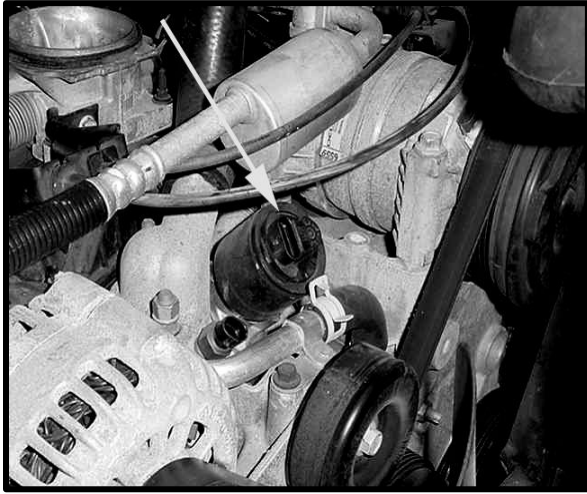

FIGURE 6.6 EGR Valve



FIGURE 6.7 Knock Sensor Connector

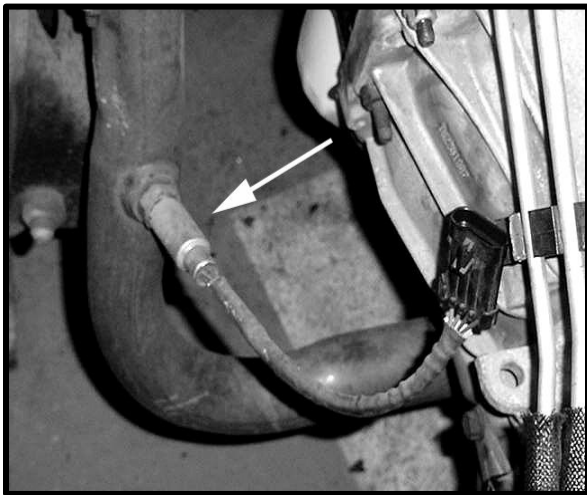

FIGURE 6.8 Oxygen Sensors

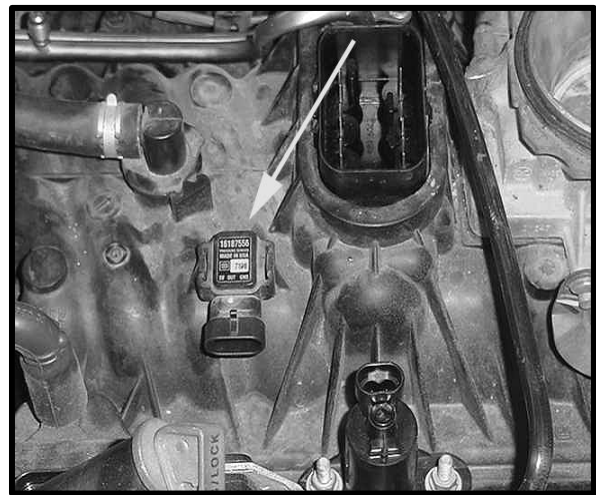

FIGURE 6.9 MAP Sensor

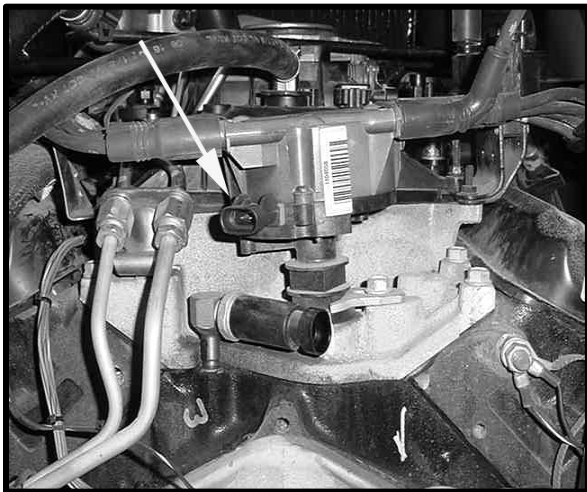

FIGURE 6.10 Cam Sensor (Dist.)

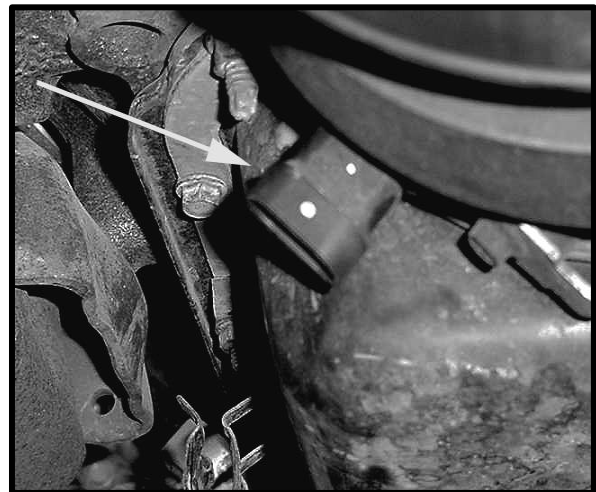

FIGURE 6.11 CPS Sensor



FIGURE 6.12 Injectors 1 - 8

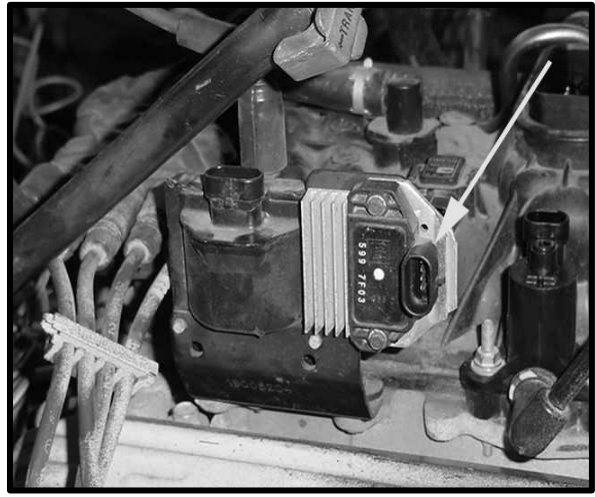

FIGURE 6.13 Coil Driver

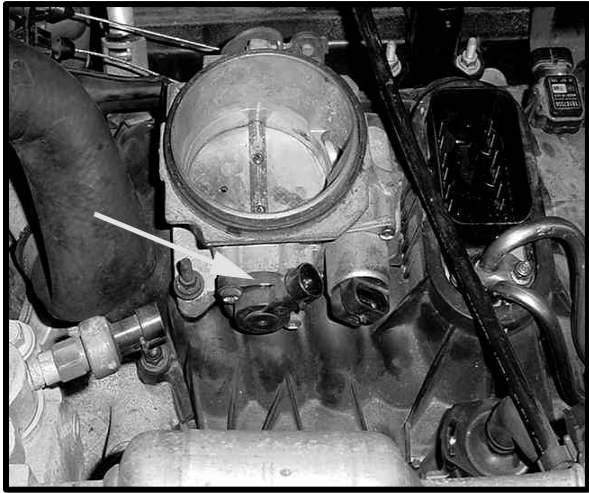

FIGURE 6.14 TPS Sensor

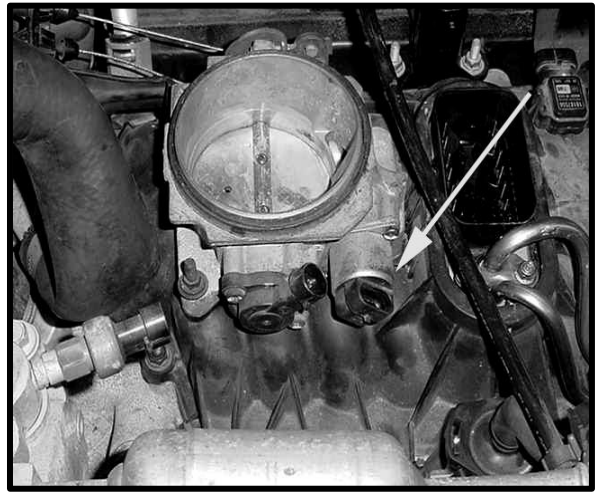

FIGURE 6.15 IAC Valve

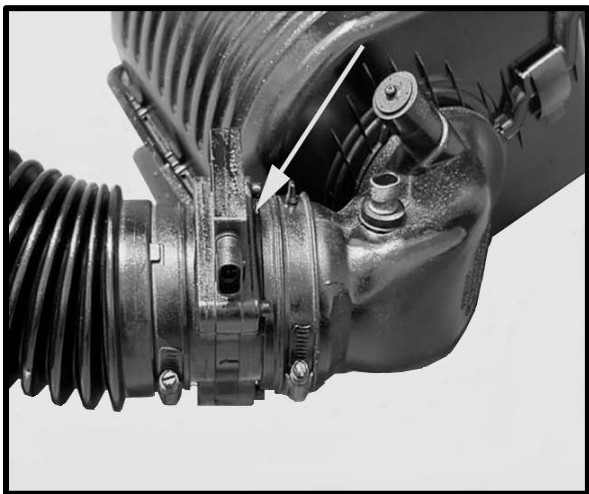

FIGURE 6.16 MAF Sensor



FIGURE 6.17 Ignition Coil

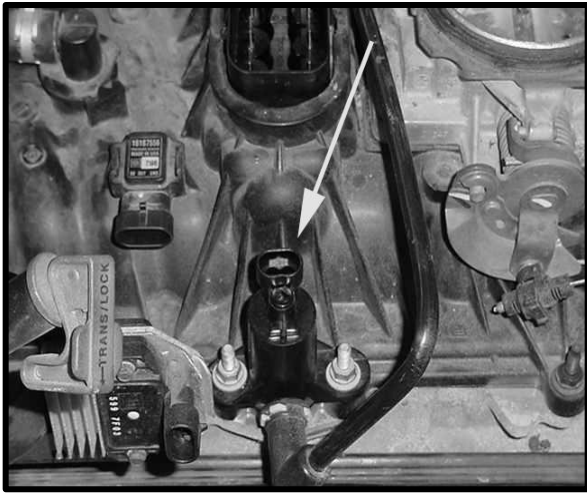

FIGURE 6.18 Canister Purge Solenoid

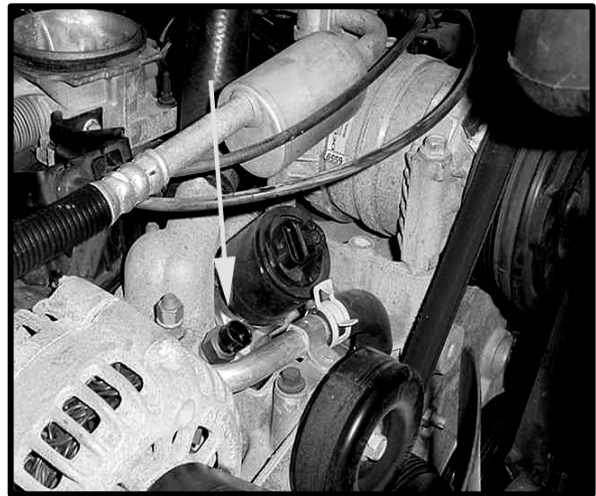

FIGURE 6.19 ECT Sensor

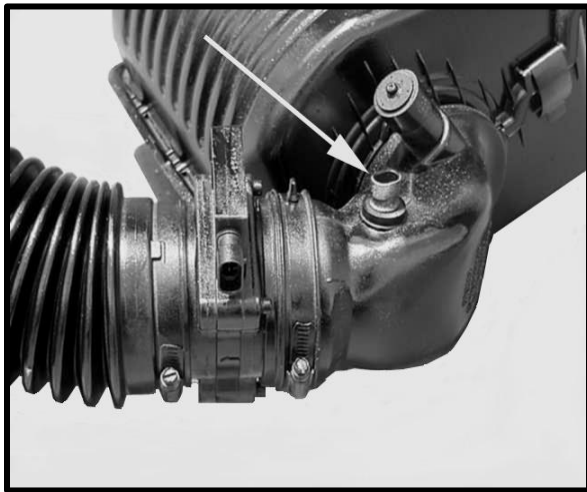

FIGURE 6.20 IAT Sensor

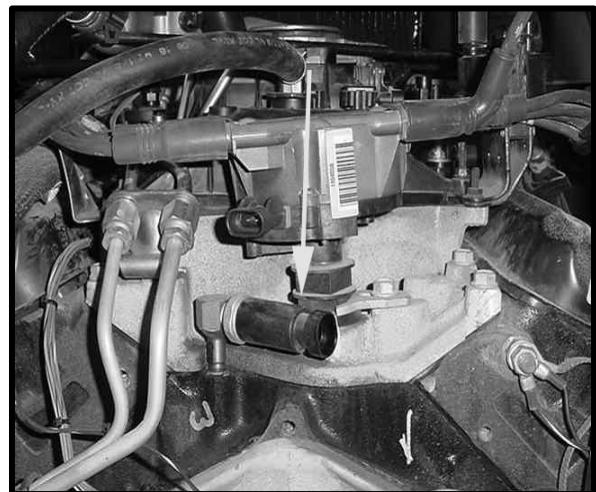

FIGURE 6.21 Fuel Pump/Oil Pressure Switch

6.4 TAIL SECTION INSTALLATION

- 6.4.1 Locate the tail section that you earlier separated from the engine group. Begin routing it towards the rear of the vehicle. Be sure to avoid all sharp edges, moving or hot parts, or anything else that may damage the harness.
- 6.4.2 If you **ARE** using the 4L60E transmission, route the 13-position connector to the transmission and attach it. Tape up the input shaft speed sensor connector and store it in the harness.
- 6.4.3 If you **ARE** using 4L80E transmission, route the input shaft speed sensor connector to the transmission and attach it.
- 6.4.4 Take the connector for the Vehicle Speed Sensor (VSS) and connect to the Vehicle Speed Sensor.
- 6.4.5 Take the gray wire labeled FUEL PUMP and route it to the fuel pump. This is the power wire for the fuel pump.

6.4.6 Tail Section Connections

<u>WIRE COLOR</u>	<u># OF POSITIONS IN CONNECTOR</u>	<u>LABELED</u>	<u>CONNECT TO:</u>
RED/BLACK, BLUE/WHITE (4L80E only)	2	VSS	Vehicle Speed Sensor
PURPLE/WHITE, GREEN/BLACK (4L60E & 4L80E)	2	VSS	Vehicle Speed Sensor
LT. GREEN, YELLOW/BLACK, YELLOW, RED/BLACK, LT. BLUE/WHITE, PINK, PINK/BLACK, BLACK, RED, BLUE, WHITE, TAN/BLACK, BROWN	13	Trans.	Transmission
GRAY			Fuel Pump Power Terminal

TABLE 6.4 Tail Section Connections

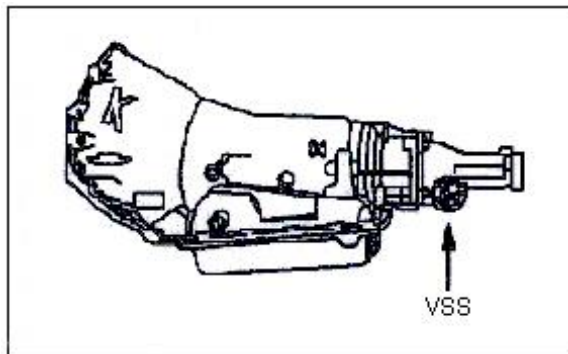

FIGURE 6.22 VSS (4L60E)

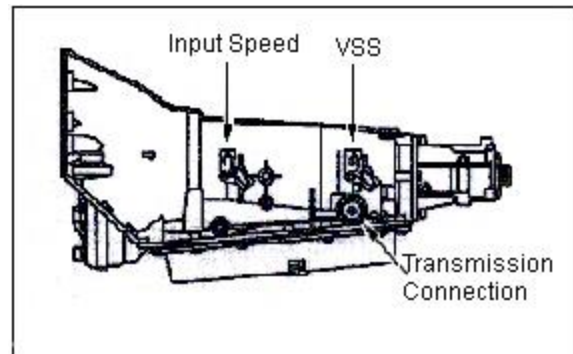

FIGURE 6.23 A/T Input Speed & VSS Sensor, Transmission Connection (4L80E)

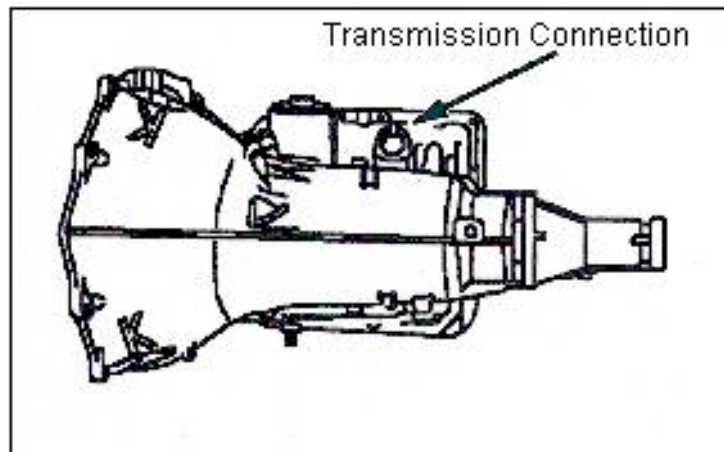

FIGURE 6.24 Transmission Connection (4L60E)

6.5 Converting 4L60E Transmission Connector to Work with a 4L80E

Note: Harness numbers 60212, 60213, 60214, and 60215 have been wired for both the 4L60E and the 4L80E. All harnesses have the transmission connector pre terminated to allow use of the 4L60E transmission. In applications where a 4L80E is to be used, follow this procedure to change your transmission connector to ensure all functions of the transmission work properly. See Figure 6.25 for repinning the transmission connector.

- 6.5.1 With the terminal end of the connector and the arrow on top pointing towards you, carefully remove the white retaining lock located in the center of the connector.
- 6.5.2 Locate the white wire located in terminal location S. Using a paper clip or small screwdriver, gently lift the locking tab inside the connector and pull the wire from it's location.
- 6.5.3 Now locate the brown wire located in terminal location U. Using the same method, remove the brown wire from its location.
- 6.5.4 Gently insert the brown wire into terminal location S.
- 6.5.5 The white wire has no function with the 4L80E transmission; it needs to be taped up and stowed in the harness in case a 4L60E is ever to be used.

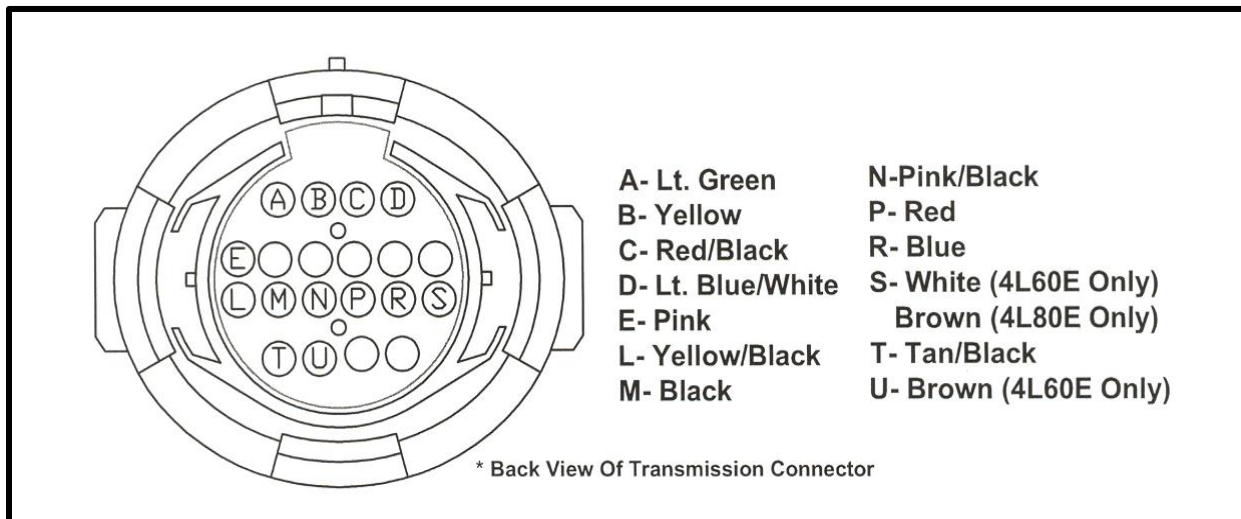

Figure 6.25 Transmission Connector Pin Out

7. TROUBLE- SHOOTING INSTRUCTIONS

If you are having trouble with your engine running badly or not running at all, first perform basic trouble-shooting (ensure that you are using the correct parts (Table 4.1), check for faulty connections, blown fuses, spark, timing, fuel pressure, etc.), then see if the computer has stored a trouble code in its memory.

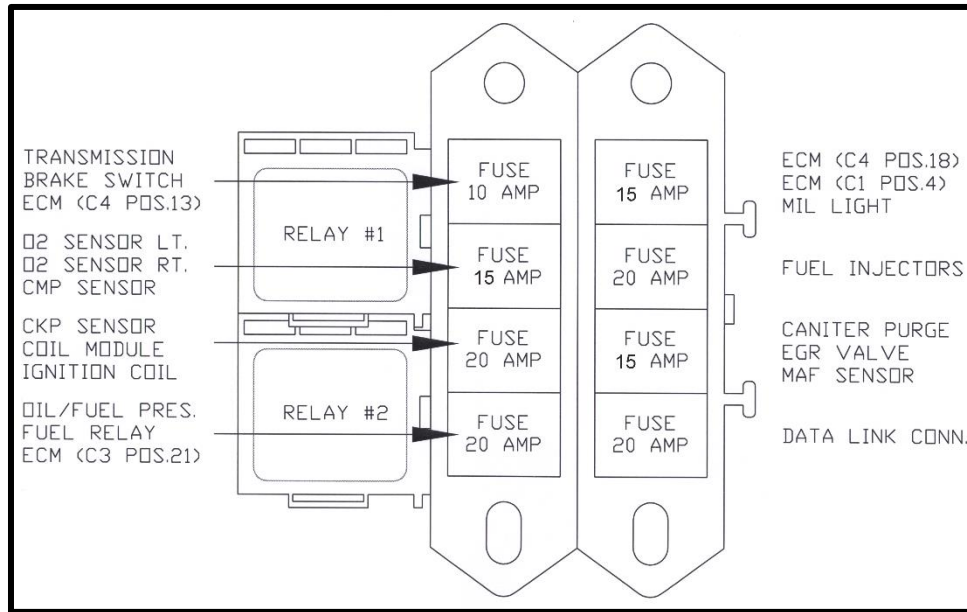

FIGURE 6.26 Fuse Identification

7.1 THE "CHECK ENGINE" LIGHT

Normally, the "check engine" light should come on when the ignition is turned on, then go out a few moments after the engine starts running. If it reappears, or stays on while the engine is running, the computer has detected a problem and a trouble code has been set.

NOTE: Most likely the check engine light will come on and stay on when using a computer with the original factory programming this is normal and is why we recommended that the computer be reprogrammed to remove any items that the factory vehicle had that aren't being used in the vehicle you are installing the engine into.

7.2 RETRIEVING TROUBLE CODES FROM THE COMPUTER

- 7.2.1 In order to retrieve the trouble codes stored in the computer, a scanner must be connected to the Assembly Diagnostic Link (DLC) connector (installed and connected in **Paragraph 6.2.1**). Follow the instructions provided with the scanner to read the codes set in the computer.
- 7.2.2 After you have read any codes, write them down for reference. Remove the connector from the DLC connector.
- 7.2.3 Take the codes one at a time and match them to the codes in the 1997 C/K Truck repair manual. This will tell you in which circuit the computer has detected a problem.

Note: A code indicates a problem in a specific circuit, NOT THAT A PARTICULAR PART IS BAD.

- 7.2.4 Before taking more extensive corrective actions for any trouble codes make sure that all connections on the indicated circuit, **INCLUDING THE COMPUTER**, are clean and tight. Inspect the wiring in the circuit for any broken, shorted, or exposed wires. Finally, ensure all ground wires are clean and secure.
- 7.2.5 If a trouble code is detected and the problem has been fixed, clear the codes by first making sure the ignition is off then disconnecting the **NEGATIVE** battery cable for at least 3 minutes.

7.3 Trouble Shooting Guide for your Painless Performance Harness

If you have installed your harness, made all the connections as outlined in the installation manual, and utilized the correct components as shown in the compatible parts list, the engine should start and run. If you are experiencing difficulties in getting the engine started, this trouble shooting guide should help you in diagnosing the problem.

7.3.1 FIRST AND FOREMOST, DO NOT TRY AND START YOUR ENGINE WITHOUT INSTALLING AND CONNECTING ALL OF THE COMPONENTS. Attempting to do so will result in a “no start” situation. This includes things like the O2 sensors, knock sensors, the “PRNDL” switch (if it applies to your harness), relays, and the ECT. It’s easy to try and skip connections just to see the engine fire up, but this could cause countless difficulties trying to diagnose the issue.

7.3.2 Before you attempt to start the engine, be sure that you have the correct ECM for your harness. The correct ECM is listed in the “compatible Parts List” on **page ???**. Also, make sure that the ECM you are using has the same service number as those listed in the “Compatible Parts List.” The ECMs listed are the General Motors ECMs that did not have VATS (vehicle anti-theft). If you do not use the ECM listed, you will experience a no start situation, because the ECM you’re using will have anti-theft in it.

The first things to check if you are experiencing a “no start” situation, but are using the correct ECM, is your battery (+) power wires to the harness and the grounds. They can be on the same head or block area but should be bolted separately, not on top of each other. Also make sure that your vehicle is grounded properly, or your grounds will not do you any good. This means the negative battery cable should be bolted to the block or the frame using a star washer. The star washer allows your ground cable to cut through any paint and makes direct contact with the metal. Then, a ground strap (also using star washers) should be bolted from the block to the frame. Last, there should be a small ground strap from the block or head to the firewall. Only when these grounds are in place will the grounds for your harness be correct.

The battery (+) power to the harness should only come straight from one end of the positive battery cable, either at the battery or at the starter. The constant battery power is what provides power to the harness for the computer (ECM) memory. If it is not going to the positive battery cable, the ECM will have to relearn initial startup procedures every time you start it.

Last, make sure that the wire tagged “**12v IGN.**” wire is connected to an ignition hot source that has power **BOTH** in the ON/RUN position as well as the START position. An easy way to tell if you connected the wires to the correct power source is to look at the check engine light.

The check engine light has a direct correlation with the “**12v IGN.**” wire. If this wire is connected to the correct power source, the check engine light will come on when the key is turned to the ON/RUN position and will stay on when the key is turned all the way to the START position. If the light goes out in either of these ignition switch key positions, this means you are losing power to the “12v IGN” wire and must find another power source for it. The engine will never fire and start if this wire does not have the proper power source.

Also, make sure your check engine light is connected to the harness at the ALDL bracket. If you think you have connected the “**12v IGN.**” wire properly, and still do not have a check engine light when you turn the key on, check to see if the light is connected to the harness. Sometimes, the harnesses are not plugged into the light. The wires that connect to the light (**PINK** and **BROWN**) are tied together near the light. They are terminated so you can connect them to the 2 **BLACK** wires coming from the light.

FUEL PRESSURE: If you have checked all of the constant/switched power and your grounds but still have a “no start” problem, move onto the fuel system. The fuel pump should come on for

a few seconds when you turn the key on and then shut off. This is to pressurize the fuel system, prepping it for start. If you turn the key on and do not hear the fuel pump come on and cycle, you need to check the fuel pump relay.

Make sure (as mentioned earlier) that the relay is plugged into the base. If it is plugged in properly, check to see if the relay might be defective. To do this, put 12 volts to the short wire marked "Test" coming out of the relay base. This wire is the same color as the wire providing power to the fuel pump. This "Test" wire will bypass the relay and apply 12 volts directly to the pump. If the fuel pump comes on when the 12 volts is applied, this tells you the relay is defective and needs to be replaced.

If your fuel pump does cycle with the key on you should check the fuel pressure. The fuel pressure should be about 60 to 62lbs. If it is not, you need a fuel pump that will deliver enough pressure to the injectors and the engine to run.

INJECTORS: Vortec injectors are susceptible to gumming up and sticking when the engine is left sitting for long periods of time (a year or more) with old fuel sitting in them. It is suggested that you clean the injectors if you do not know how long the engine has set.

If your injectors are clean and free, check to see if you have injector pulse. The best way to do this is to use this link.

<https://troubleshootmyvehicle.com › gm › testing-the-spider-fuel-injector-1>

Also check your relays in the harness fuse center. These relays control power to the O2 sensors and the injectors.

SPARK: if you have checked and cleared all of the previously mentioned components and still have a "no start" condition, you need to check for spark at the coils.

If all these things check out, you should be getting air/spark/fuel and that is what it takes to fire your engine. Remember, it does not pay to try and start your engine without everything installed and connected as it leads to undue frustrations.

7.4 WHEN TO CALL PAINLESS PERFORMANCE PRODUCTS' TECH LINE

- 7.4.1 These harness kits have been built with the highest regard to quality control. Before calling us please double check all connections and perform normal basic trouble-shooting (fuel pressure, timing, ignition system, etc.).
- 7.4.2 If you have any questions concerning the installation of this harness or having trouble in general, feel free to call Painless Performance Products' tech line at 1-800-423-9696. Calls are answered from 8am to 5pm central time, Monday thru Friday, except holidays. Email questions to Tech@painlessperformance.com

Painless Performance Products, LLC

Limited Warranty and Return Policy

Chassis harnesses, fuel injection harnesses, and Trail Rocker units are covered under a lifetime warranty.

All other products manufactured and/or sold by Painless Performance are warranted to the original purchaser to be free from defects in material and workmanship under normal use. Painless Performance will repair or replace defective products without charge during the first 12 months from the purchase date. No products will be considered for warranty without a copy of the purchase receipt showing the sellers name, address, and date of purchase. You must return the product to the dealer you purchased it from to initiate warranty procedures.